

AIX Version 7.3

*Printing*

**IBM**

**Note**

Before using this information and the product it supports, read the information in [“Notices” on page 277.](#)

This edition applies to AIX Version 7.3 and to all subsequent releases and modifications until otherwise indicated in new editions.

© **Copyright International Business Machines Corporation 2021.**

US Government Users Restricted Rights – Use, duplication or disclosure restricted by GSA ADP Schedule Contract with IBM Corp.

---

# Contents

<b>About this document.....</b>	<b>vii</b>
Highlighting.....	vii
Case-sensitivity in AIX.....	vii
ISO 9000.....	vii
<b>Printing.....</b>	<b>1</b>
Printing and print jobs.....	1
Starting a print job.....	1
Canceling a print job (qcan command).....	4
Canceling a print job (SMIT).....	5
Prioritizing a print job (qpri command).....	5
Prioritizing a print job (SMIT).....	5
Moving a print job to another print queue ( <b>qmov</b> command).....	6
Moving a print job to another print queue (SMIT).....	6
Holding and releasing print jobs ( <b>qhld</b> command).....	7
Holding and releasing print jobs (SMIT).....	7
Checking the status of a print job (qchk command).....	8
Checking the status of a print job (SMIT).....	9
Formatting files for printing (pr command).....	10
Printing ASCII files on a PostScript printer.....	11
Command summary for printing.....	13
Printing administration.....	14
Printing processes.....	14
Initial printer configuration.....	15
Print queue operations.....	18
Configuration of nonsupported printers.....	20
Printing with terminal-attached printers.....	22
terminfo database.....	26
Adding support for non-supported terminals.....	26
Native, 8-port, 16-port, and third-party controllers.....	27
64-port controller.....	27
128-port controller.....	27
Printer backend commands.....	28
Listing print queues.....	28
Showing status of print queues.....	28
Starting and stopping a print queue.....	28
Setting the default print queue.....	29
Scheduling print jobs.....	29
Changing or showing queue characteristics.....	29
Deleting a print queue.....	30
Performing other printer administration tasks.....	30
Remote printing.....	33
Managing and using remote printers and queues.....	35
Printing bidirectional data.....	38
Bidirectional Print Filters.....	38
Printing Bidirectional Data using the /usr/bin/ebprt filter.....	38
Tabular Data Support and What to Expect.....	38
Locale and Codepage Support.....	39
Installation and Packaging.....	39
Configuring the Print Subsystem to use the Bidirectional Print Filter.....	39

Configuring the /etc/ebprt.conf configuration file.....	39
Configuration Examples.....	43
Troubleshooting.....	44
Known limitations of escape sequence and PCL support.....	44
Print spooler.....	44
Formatter filters.....	44
Local and remote printers.....	45
Printer devices.....	45
qdaemon process.....	45
Real (physical) and virtual printers.....	45
Spooler functions and services.....	45
Spooler backends.....	46
Spooler jobs.....	46
Generic base operating system spooler .....	47
Spooler parts.....	47
Spooler data flow: commands and backend.....	47
Spooler data flow (enq command).....	48
Backend processing.....	49
Datastream flow for common print jobs.....	50
Virtual printers and formatter filters.....	52
/etc/qconfig spooler configuration file.....	53
/etc/qconfig file structure.....	53
Spooler queues, virtual printers, and physical printers .....	54
Spooler queue names and status formats.....	55
Printer backend programming.....	56
Printer backend data flow.....	56
Virtual printer definitions and attributes.....	57
Virtual printer attributes.....	57
Printer colon file escape sequences.....	65
Printer colon file conventions.....	71
Colon file format.....	71
Virtual printer attribute names.....	72
Attribute values.....	75
Colon file limits field.....	75
Print formatter example.....	76
Backend and qdaemon interaction.....	79
Status file.....	79
Multiple copy printing.....	79
Job status information.....	80
Print job charges.....	80
Exit codes.....	80
Returned error messages.....	81
Queue states.....	83
Termination on receipt of SIGTERM.....	83
Back-end routines in libqb.....	83
Printer code page translation tables.....	85
Printer code page translation for multibyte code sets.....	85
Printer attachment files.....	89
Transparent printing.....	134
Configuring a printer or plotter connected to a RAN.....	135
Configuring terminal-attached printers.....	135
Printer-specific information.....	137
IBM Personal Printer II Models 2380, 2381, 2390, 2391, 2380-2, 2381-2, 2390-2, 2391-2.....	137
IBM 3812 Model 2 Page Printer.....	137
IBM 3816 Page Printer.....	138
IBM 4019 LaserPrinter and 4029 LaserPrinter.....	138
IBM 4037 and IBM 4039 LaserPrinter.....	139
IBM 4072 ExecJet.....	139

IBM 4076 InkJet Printer.....	139
IBM Proprinter Models 4201-3, 4202-3, 4207-2, 4208-2.....	140
IBM 4208-502, IBM 5572-B02, IBM 5573-H02, and IBM 5579-H02/K02.....	140
IBM 4216 Personal Page Printer, Model 031.....	140
IBM 4216-510 and IBM 5327-011.....	140
IBM 4234 Printer.....	141
IBM 5202 Quietwriter III.....	141
IBM 5204 Quickwriter.....	141
IBM 5575-B02/F02/H02 and IBM 5577-B02/F02/FU2/G02/H02/J02/K02.....	141
IBM 5584-G02/H02, IBM 5585-H01, IBM 5587-G01/H01 and IBM 5589-H01.....	142
IBM 6252 Impactwriter and IBM 6252 Printer.....	142
IBM Network Color Printer.....	142
IBM Network Printer 12, 17, and 24.....	144
IBM InfoPrint 20.....	146
IBM InfoPrint 32 Printer.....	149
IBM InfoPrint 40 Printer.....	153
Canon LASER SHOT LBP-B404PS/Lite.....	156
Canon LASER SHOT LBP-B406S/D/E/G, A404/E, A304E.....	156
Dataproducs LZR 2665 Laser Printer.....	156
Hewlett-Packard LaserJets II, III, IIISi, 3005, 4, 4Si, 4Plus, 4V, 4000, 5200, 5Si/5Si MX, 5Si Mopier, 4700 Color, 8000 Color, and 8500 Color.....	156
Lexmark 4227 Forms Printer.....	164
Lexmark Optra Laser Printer.....	165
Lexmark Optra Plus LaserPrinter.....	168
Lexmark Optra Color 1200 Printer.....	172
Lexmark Optra Color 40 Printer.....	175
Lexmark Optra Color 45 Printer.....	178
Lexmark Optra K 1220 Printer.....	181
Lexmark Optra C Color LaserPrinter.....	184
Lexmark Optra E LaserPrinter.....	186
Lexmark Optra N LaserPrinter.....	189
Lexmark Optra E310 Laser Printer.....	194
Lexmark Optra M410 Laser Printer.....	196
Lexmark Optra Se Laser Printer.....	199
Lexmark Optra T Laser Printer Family.....	202
Lexmark Optra W810 Laser Printer.....	206
Lexmark Plus Printer Models 2380-3, 2381-3, 2390-3, 2391-3.....	212
OKI MICROLINE 801PS/+F, 801PSII/+F, 800PSIILT.....	214
Printronix P9012 Line Printer.....	214
QMS ColorScript 100 Model 20 Printer.....	214
Texas Instruments OmniLaser 2115 Page Printer.....	214
System V printer configuration.....	214
System V print service.....	215
Default printer page size and spacing.....	218
Banner configuration.....	219
/etc/lp/Systems file administration.....	220
Printer models file.....	220
Printer interface scripts.....	221
terminfo database.....	225
Printer forms.....	227
Adding a form to the print service.....	227
Removing a form.....	228
User access to forms.....	228
Mounting a form.....	229
Examining a form.....	229
Print filters.....	230
PostScript printers.....	240
Directory-enabled (LDAP) System V print on AIX.....	254

Base operating system spooler troubleshooting.....	260
Troubleshooting a local printer.....	261
Troubleshooting an inoperative printer.....	261
Troubleshooting a remote printer.....	262
Adapter considerations.....	262
Resource considerations.....	262
Correcting printing problems when the var file system is full.....	263
Troubleshooting the terminal-attached printer.....	267
Considerations for an 8-bit printer attached to a 7-bit interface.....	268
Troubleshooting the queue daemon.....	268
Queuing system problems.....	269
qdaemon testing.....	270
Spooler queue testing.....	271
Spooled print job copies.....	271
Cleaning up and starting over.....	272
Printing terminology.....	272
<b>Notices.....</b>	<b>277</b>
Privacy policy considerations.....	278
Trademarks.....	279
<b>Index.....</b>	<b>281</b>

## About this document

---

This document provides users and system administrators with complete information about how to perform such tasks as printing files, managing the progress of print requests, and configuring printers. For more advanced users and programmers, this book contains information on print spooling and topics such as the printer backend. This publication is also available on the documentation CD that is shipped with the operating system.

## Highlighting

---

The following highlighting conventions are used in this document:

<b>Bold</b>	Identifies commands, subroutines, keywords, files, structures, directories, and other items whose names are predefined by the system. Also identifies graphical objects such as buttons, labels, and icons that the user selects.
<i>Italics</i>	Identifies parameters whose actual names or values are to be supplied by the user.
Monospace	Identifies examples of specific data values, examples of text similar to what you might see displayed, examples of portions of program code similar to what you might write as a programmer, messages from the system, or information you should actually type.

## Case-sensitivity in AIX

---

Everything in the AIX operating system is case-sensitive, which means that it distinguishes between uppercase and lowercase letters. For example, you can use the **ls** command to list files. If you type LS, the system responds that the command is not found. Likewise, **FILEA**, **FiLea**, and **filea** are three distinct file names, even if they reside in the same directory. To avoid causing undesirable actions to be performed, always ensure that you use the correct case.

## ISO 9000

---

ISO 9000 registered quality systems were used in the development and manufacturing of this product.



---

# Printing

Learn how to print files, manage the progress of print requests, configure printers. You can also learn about the concepts and procedures for print spooling and printer backend functions.

## Printing and print jobs

---

Printing in AIX offers a myriad of configuration and setup options.

Depending on the printer you use, the AIX® operating system controls the appearance and characteristics of the final output. The printers are not required to be in the same area as the system unit and the system console. You might decide to attach your printer directly to a local system, or your situation might require you to send print jobs over a network to a remote system.

To handle print jobs with maximum efficiency, the AIX operating system places each job into a queue to await printer availability. The system can save output from one or more files in the queue. As the printer produces the output from one file, the system processes the next job in the queue. This process continues until each job in the queue is printed.

### Starting a print job

Use the **qprt** or **smit** command to request a print job.

- For local print jobs, the printer must be physically attached to your system or, in the case of a network printer, attached and configured on the network.
- For remote print jobs, your system must be configured to communicate with the remote print server.
- Before you can print a file, you must have *read* access to it. To remove a file after it has printed, you must have *write* access to the directory that contains the file.

Specify the following information to request a print job:

- Name of the file to print
- Print queue name
- Number of copies to print
- Whether to make a copy of the file on the remote host
- Whether to erase the file after printing
- Whether to send notification of the job status
- Whether to send notification of the job status by the system mail
- Burst status
- User name for "Delivery To" label
- Console acknowledgment message for remote print
- File acknowledgment message for remote print
- Priority level

Use the **qprt** command to create and queue a print job to print the file you specify. If you specify more than one file, all the files together make up one print job. These files are printed in the order specified on the command line.

The basic format of the **qprt** command is:

```
qprt -PQueueName FileName
```

The following **qprt** command flags are useful:

Item	Descriptor
-b <i>Number</i>	Specifies the bottom margin. The bottom margin is the number of blank lines to be left at the bottom of each page.
-B <i>Value</i>	<p>Specifies whether burst pages (continuous-form pages separated at perforations) should be printed. The <i>Value</i> variable consists of a two-character string. The first character applies to header pages. The second character applies to trailer pages. Each of the two characters can be one of the following:</p> <p><b>a</b> Always prints the (header or trailer) page for each file in each print job.</p> <p><b>n</b> Never prints the (header or trailer) page.</p> <p><b>g</b> Prints the (header or trailer) page once for each print job (group of files). For example, the <b>-B ga</b> flag specifies that a header page be printed at the beginning of each print job and that a trailer page be printed after each file in each print job.</p> <p style="text-align: center;">In a remote print environment, the default is determined by the remote queue on the server.</p>
-e <i>Option</i>	<p>Specifies whether emphasized print is wanted.</p> <p><b>+</b> Indicates emphasized print is wanted.</p> <p><b>!</b> Indicates emphasized print is not wanted.</p>
-E <i>Option</i>	<p>Specifies whether double-high print is wanted.</p> <p><b>+</b> Indicates double-high print is wanted.</p> <p><b>!</b> Indicates double-high print is not wanted.</p>
-f <i>FilterType</i>	A one-character identifier that specifies a filter through which your print file or files are to be passed before being sent to the printer. The available filter identifiers are <b>p</b> , which invokes the <b>pr</b> filter, and <b>n</b> , which processes output from the <b>troff</b> command.
-i <i>Number</i>	Causes each line to be indented the specified number of spaces. The <i>Number</i> variable must be included in the page width specified by the -w flag.
-K <i>Option</i>	<p>Specifies whether condensed print is wanted.</p> <p><b>+</b> Indicates condensed print is wanted.</p> <p><b>!</b> Indicates condensed print is not wanted.</p>
-l <i>Number</i>	Sets the page length to the specified number of lines. If the <i>Number</i> variable is 0, the page length is ignored, and the output is considered to be one continuous page. The page length includes the top and bottom margins and indicates the printable length of the paper.

Item	Descriptor
-L <i>Option</i>	<p>Specifies whether lines wider than the page width should be wrapped to the next line or truncated at the right margin.</p> <p><b>+</b> Indicates that long lines should wrap to the next line.</p> <p><b>!</b> Indicates that long lines should not wrap but instead should be truncated at the right margin.</p>
-N <i>Number</i>	<p>Specifies the number of copies to be printed. If this flag is not specified, one copy is printed.</p>
-p <i>Number</i>	<p>Sets the pitch to <i>Number</i> characters per inch. Typical values for <i>Number</i> are 10 and 12. The actual pitch of the characters printed is also affected by the values for the -K (condensed) flag and the -W (double-wide) flag.</p>
-P <i>Queue[:QueueDevice]</i>	<p>Specifies the print queue name and the optional queue device name. If this flag is not specified, the default printer is assumed.</p>
-Q <i>Value</i>	<p>Specifies paper size for the print job. The <i>Value</i> for paper size is printer-dependent. Typical values are <b>1</b> for letter-size paper, <b>2</b> for legal, and so on. Consult your printer manual for the values assigned to specific paper sizes.</p>
-t <i>Number</i>	<p>Specifies the top margin. The top margin is the number of blank lines to be left at the top of each page.</p>
-w <i>Number</i>	<p>Sets the page width to the number of characters specified by the <i>Number</i> variable. The page width must include the number of indention spaces specified with the -i flag.</p>
-W <i>Option</i>	<p>Specifies whether double-wide print is wanted.</p> <p><b>+</b> Indicates double-wide print is wanted.</p> <p><b>!</b> Indicates double-wide print is not wanted.</p>
-z <i>Value</i>	<p>Rotates page printer output the number of quarter-turns clockwise as specified by the <i>Value</i> variable. The length (-l) and width (-w) values are automatically adjusted accordingly.</p> <p><b>0</b> Portrait</p> <p><b>1</b> Landscape right</p> <p><b>2</b> Portrait upside-down</p> <p><b>3</b> Landscape left</p>

Item	Descriptor
-# Value	<p>Specifies a special function.</p> <p><b>j</b> Displays the job number for the specified print job.</p> <p><b>h</b> Queues the print job, but puts it in the <b>HELD</b> state until it is released again.</p> <p><b>v</b> Validates the specified printer backend flag values. This validation is useful in checking for illegal flag values at the time of submitting a print job. If the validation is not specified, an incorrect flag value will stop the print job later when the job is actually being processed.</p>

The following list contains examples of how to use the **qprt** command flags:

- To request that the `myfile` file be printed on the first available printer configured for the default print queue using default values, type:

```
qprt myfile
```

- To request that the `myfile` file be printed on a specific queue using specific flag values and to validate the flag values at the time of print job submission, type:

```
qprt -f p -e + -Pfastest -# v myfile
```

This passes the `myfile` file through the **pr** filter command (the `-f p` flag) and prints it using emphasized mode (the `-e +` flag) on the first available printer configured for the queue named **fastest** (the `-Pfastest` flag).

- To print the `myfile` file on legal-size paper, type:

```
qprt -Q2 myfile
```

- To print three copies of each of the `new.index.c`, `print.index.c`, and `more.c` files at the print queue `Msp1`, type:

```
qprt -PMsp1 -N 3 new.index.c print.index.c more.c
```

- To print three copies of the concatenation of three files, `new.index.c`, `print.index.c`, and `more.c`, type:

```
cat new.index.c print.index.c more.c | qprt -PMsp1 -N 3
```

**Note:** The base operating system also supports the BSD UNIX print command **lpr** and the System V UNIX print command **lp**.

You can also use SMIT to request a print job. To start a print job using SMIT, type:

```
smit qprt
```

## Canceling a print job (qcan command)

You can use the **qcan** command to cancel a print job.

- For local print jobs, the printer must be physically attached to your system or, in the case of a network printer, attached and configured on the network.
- For remote print jobs, your system must be configured to communicate with the remote print server.

When you cancel a print job, you are prompted to provide the name of the print queue where the job resides and the job number to be canceled.

This procedure applies to both local and remote print jobs.

Use the **qcan** command to cancel either a particular job number in a local or remote print queue, or all jobs in a local print queue. To determine the job number, use the **qchk** command.

The basic format of the **qcan** command is:

```
qcan -P QueueName -x JobNumber
```

The following list contains examples of how to use the **qcan** command:

- To cancel job number **123** on whichever printer the job is on, type: `qcan -x 123`
- To cancel all jobs queued on printer **lp0**, type: `qcan -X -Plp0`

**Note:** The base operating system also supports the BSD UNIX cancel print command **lprm** and the System V UNIX cancel print command **cancel**.

## Canceling a print job (SMIT)

You can use SMIT to cancel a print job.

- For local print jobs, the printer must be physically attached to your system or, in the case of a network printer, attached and configured on the network.
- For remote print jobs, your system must be configured to communicate with the remote print server.

To cancel a print job using SMIT, type:

```
smit qcan
```

You can then select the print job number or printer.

## Prioritizing a print job (qpri command)

You can assign job priority only on local queues using the **qpri** command.

The printer must be physically attached to your system.

Higher values indicate a higher priority for the print job. The default priority is **15**. The maximum priority is **20** for most users, and **30** for users with root user privilege and members of the **printq** group (group **9**).

**Note:** You cannot assign a priority to a remote print job.

Use the **qpri** command to reassign the priority of a print job that you submitted. If you have root user authority or belong to the **printq** group, you can assign priority to any job while it is in the print queue.

The basic format of the **qpri** command is:

```
qpri -# JobNumber -a PriorityLevel
```

The following list contains examples of how to use the **qpri** command:

- To change job number 123 to priority number 18, type:

```
qpri -# 123 -a 18
```

- To prioritize a local print job as it is submitted, type:

```
qpri -PQueueName -R PriorityLevel FileName
```

## Prioritizing a print job (SMIT)

You can assign job priority only on local queues.

The printer must be physically attached to your system.

Higher values indicate a higher priority for the print job. The default priority is **15**. The maximum priority is **20** for most users, and **30** for users with root user privilege and members of the **printq** group (group **9**).

**Note:** You cannot assign a priority to a remote print job.

To change the priority of a print job using SMIT, type:

```
smit qpri
```

## Moving a print job to another print queue (qmov command)

You can move a print job between queues with the **qmov** command.

To perform this task, the following prerequisites must be met:

- The printer must be physically attached to your system.
- You must be the print job owner.
- You must have root authority.
- You must be a member of the **printq** group.

**Note:** You cannot move a remote print job to another print queue.

Use the **qmov** command to move a print job to another print queue. You can either move a particular print job, or you can move all the print jobs on a specified print queue. You can also move all the print jobs that are sent by a specified user. To determine the print job number, use the **qchk** command. For more information, see [qchk](#).

The basic format of the **qmov** command follows:

```
qmov -mNewQueue {[ -#JobNumber ] [ -PQueue ] [ -uUser ]}
```

You can move a print job with one of the following commands:

- `qmov -m DestinationQueue -# JobNumber`
- `qmov -m DestinationQueue -P Queue`
- `qmov -m DestinationQueue -u User`

The following list contains examples of how to use the [qmov](#) command:

- To move job number 280 to print queue hp2, type:

```
qmov -mhp2 -#280
```

- To move all print jobs on print queue hp4D to print queue hp2, type:

```
qmov -mhp2 -Php4D
```

## Moving a print job to another print queue (SMIT)

If your printer is attached to your system, you can move a print job to another print queue with SMIT.

If your printer is physically attached to your system, you can move a print job to another print queue with System Management Interface Tool (SMIT).

To perform this task, the following prerequisites must be met:

- The printer must be physically attached to your system.
- You must be the print job owner.
- You must have root authority.
- You must be a member of the **printq** group.

**Note:** You cannot move a remote print job to another print queue.

Type the following command:

```
smit qmov
```

## Holding and releasing print jobs (qhld command)

You can hold and release print jobs with the **qhld** command.

**Note:** You cannot hold and release remote print jobs.

To perform this task, the following prerequisites must be met:

- The printer must be physically attached to your system.
- You must be the print job owner.
- You must have root authority.
- You must be a member of the `printq` group.

Use the **qhld** command to put a print job on hold after you sent it. You can either put a particular print job on hold, or you can hold all the print jobs on a specified print queue. To determine the print job number, enter the **qchk** command. The basic format of the **qhld** command follows:

```
qhld [ -r ] { [ -#JobNumber ] [ -PQueue ] [ -uUser ] }
```

You can hold a print job by using one of the following commands:

- `qhld -#JobNumber`
- `qhld -PQueue`
- `qhld -uUser`

You can release a print job by using one of the following commands:

- `qhld -r -#Jobnumber`
- `qhld -r -PQueue`
- `qhld -r -uUser`

The following list contains examples of how to use the **qhld** command:

1. To hold job number 452 on whichever print queue the job is on, type the following command:

```
qhld -#452
```

2. To hold all jobs queued on print queue hp2, type the following command:

```
qhld -Php2
```

3. To release job number 452 on whichever print queue the job is on, type the following command:

```
qhld -#452 -r
```

4. To release all jobs queued on print queue hp2, type the following command:

```
qhld -Php2 -r
```

## Holding and releasing print jobs (SMIT)

You can hold and release print jobs using SMIT.

To hold or release a print job, you must be one of the following people:

- Print job owner
- A user with root authority
- A member of the **printq** group

To hold or release a print job:

- `smit qhld`

## Checking the status of a print job (qchk command)

You can use the **qchk** command to check the status of a print job.

- For local print jobs, the printer must be physically attached to your system or, in the case of a network printer, attached and configured on the network.
- For remote print jobs, your system must be configured to communicate with the remote print server.

Use the **qchk** command to display the current status information regarding specified print jobs, print queues, or users.

The basic format of the **qchk** command is:

```
qchk -P QueueName -# JobNumber -u OwnerName
```

**Note:** The base operating system also supports the BSD UNIX check print queue command **lpq** and the System V UNIX check print queue command **lpstat**.

The following list contains examples of how to use the **qchk** command:

- To display the default print queue, type:

```
qchk -q
```

- To display the long status of all queues until empty, while updating the screen every **5** seconds, type:

```
qchk -A -L -w 5
```

- To display the status for print queue **lp0**, type:

```
qchk -P lp0
```

- To display the status for job number **123**, type:

```
qchk -# 123
```

- To check the status of all jobs in all queues, type:

```
qchk -A
```

### Print queue status conditions

Some of the status conditions that a print queue can have are:

#### DEV\_BUSY

Indicates that:

- More than one queue is defined to a printer device (**lp0**) and another queue is currently using the printer device.
- **qdaemon** attempted to use the printer port device (**lp0**), but another application is currently using that printer device

To recover from a **DEV\_BUSY**, wait until the queue or application has released the printer device, or cancel the job or process that is using the printer port.

#### DEV\_WAIT

Indicates that the queue is waiting on the printer because the printer is offline, out of paper, jammed, or the cable is loose, bad, or wired incorrectly.

To recover from a **DEV\_WAIT**, correct the problem that caused it to wait. It might be easier for diagnostic testing to use the **enq** command to move all queued jobs from the **DEV\_WAIT** queue to

another queue that is either printing or is **DOWN**. After the problem is corrected, you can move any unprinted job back to the original queue.

#### **DOWN**

A queue usually goes into a **DOWN** state after it has been in the **DEV\_WAIT** state. This situation occurs when the printer device driver cannot tell if the printer is there because of absence of correct signaling. However, some printers might not have the capability to signal the queuing system that they are offline, and they instead send signals that they are off. If the printer device signals or appears to be off, the queue will go into the **DOWN** state.

To recover from a **DOWN** state, correct the problem that brought the queue down and have the system administrator bring the queue back up. The queue must be manually brought up before it can be used again.

#### **HELD**

Specifies that a print job is held. The print job cannot be processed by the spooler until it is released.

#### **QUEUED**

Specifies that a print file is queued and is waiting in line to be printed.

#### **READY**

Specifies that everything involved with the queue is ready to queue and print a job.

#### **RUNNING**

Specifies that a print file is printing.

## Checking the status of a print job (SMIT)

You can use the **smit** command to check the status of a print job.

- For local print jobs, the printer must be physically attached to your system or, in the case of a network printer, attached and configured on the network.
- For remote print jobs, your system must be configured to communicate with the remote print server.

You can display the current status information for specified job numbers, queues, printers, or users. To check a print job's status using SMIT, type:

```
smit qchk
```

### Print queue status conditions

Some of the status conditions that a print queue can have are:

Item	Description
<b>DEV_BUSY</b>	Indicates that: <ul style="list-style-type: none"><li>• More than one queue is defined to a printer device (<b>lp0</b>) and another queue is currently using the printer device.</li><li>• <b>qdaemon</b> attempted to use the printer port device (<b>lp0</b>), but another application is currently using that printer device</li></ul> To recover from a <b>DEV_BUSY</b> , wait until the queue or application has released the printer device, or cancel the job or process that is using the printer port.
<b>DEV_WAIT</b>	Indicates that the queue is waiting on the printer because the printer is offline, out of paper, jammed, or the cable is loose, bad, or wired incorrectly.  To recover from a <b>DEV_WAIT</b> , correct the problem that caused it to wait. It might be easier for diagnostic testing to use the <b>enq</b> command to move all queued jobs from the <b>DEV_WAIT</b> queue to another queue that is either printing or is <b>DOWN</b> . After the problem is corrected, you can move any unprinted job back to the original queue.

Item	Description
<b>DOWN</b>	A queue usually goes into a <b>DOWN</b> state after it has been in the <b>DEV_WAIT</b> state. This situation occurs when the printer device driver cannot tell if the printer is there because of absence of correct signaling. However, some printers might not have the capability to signal the queuing system that they are offline, and they instead send signals that they are off. If the printer device signals or appears to be off, the queue will go into the <b>DOWN</b> state.  To recover from a <b>DOWN</b> state, correct the problem that brought the queue down and have the system administrator bring the queue back up. The queue must be manually brought up before it can be used again.
<b>HELD</b>	Specifies that a print job is held. The print job cannot be processed by the spooler until it is released.
<b>QUEUED</b>	Specifies that a print file is queued and is waiting in line to be printed.
<b>READY</b>	Specifies that everything involved with the queue is ready to queue and print a job.
<b>RUNNING</b>	Specifies that a print file is printing.

## Formatting files for printing (pr command)

You can use the **pr** command to perform simple formatting of files that are sent to a printer.

You can pipe the output of the **pr** command to the **qprt** command to format your text.

Some useful **pr** command flags are:

Item	Descriptor
<b>-d</b>	Double-spaces the output.
<b>-h "String"</b>	Displays the specified string, enclosed in quotes (" "), instead of the file name as the page header. Separate the flag and string by a space.
<b>-l Lines</b>	Overrides the 66-line default and resets the page length to the number of lines specified by the <i>Lines</i> variable. If the <i>Lines</i> value is smaller than the sum of both the header and trailer depths (in lines), the header and trailer are suppressed (as if the <b>-t</b> flag were in effect).
<b>-m</b>	Merges files. Standard output is formatted so the <b>pr</b> command writes one line from each file specified by a <i>File</i> variable, side by side into text columns of equal fixed widths, based on the number of column positions. This flag should not be used with the <b>-Column</b> flag.
<b>-n [Width] [Character]</b>	Provides line numbering based on the number of digits specified by the <i>Width</i> variable. The default is 5 digits. If the <i>Character</i> (any nondigit character) variable is specified, it is appended to the line number to separate it from what follows on the line. The default character separator is the ASCII Tab character.
<b>-o Offset</b>	Indents each line by the number of character positions specified by the <i>Offset</i> variable. The total number of character positions per line is the sum of the width and offset. The default value of <i>Offset</i> is 0.
<b>-s Character</b>	Separates columns by the single character specified by the <i>Character</i> variable instead of by the appropriate number of spaces. The default value for <i>Character</i> is an ASCII Tab character.
<b>-t</b>	Does not display the five-line identifying header and the five-line footer. Stops after the last line of each file without spacing to the end of the page.

Item	Descriptor
<b>-w</b> <i>Width</i>	Sets the number of column positions per line to the value specified by the <i>Width</i> variable. The default value is 72 for equal-width multicolumn output. There is no limit otherwise. If the <b>-w</b> flag is not specified and the <b>-s</b> flag is specified, the default width is 512 column positions.
<b>-C</b> <i>Column</i>	Sets the number of columns to the value specified by the <i>Column</i> variable. The default value is 1. Do not use this option with the <b>-m</b> flag. The <b>-e</b> and <b>-i</b> flags are assumed for multicolumn output. A text column should never exceed the length of the page (see the <b>-l</b> flag). When this flag is used with the <b>-t</b> flag, use the minimum number of lines to write the output.
<b>+Page</b>	Begins the display with the page number specified by the <i>Page</i> variable. The default value is 1.

The following is a list of examples of how **pr** command flags can be used:

- To print a file named `prog.c` with headings and page numbers on the printer, type:

```
pr prog.c | qprt
```

This command adds page headings to `prog.c` and sends it to the **qprt** command. The heading consists of the date the file was last modified, the file name, and the page number.

- To specify a title for a file named `prog.c`, type:

```
pr -h "MAIN PROGRAM" prog.c | qprt
```

This prints `prog.c` with the title `MAIN PROGRAM` in place of the file name. The modification date and page number are still printed.

- To print a file named `word.lst` in multiple columns, type:

```
pr -3 word.lst | qprt
```

This prints the `word.lst` file in three vertical columns.

- To print several files side by side on the paper, type:

```
pr -m -h "Members and Visitors" member.lst visitor.lst | qprt
```

This prints `member.lst` and `visitor.lst` side by side with the title **Members and Visitors**.

- To modify a file named `prog.c` for later use, type:

```
pr -t -e prog.c > prog.notab.c
```

This command replaces tab characters in `prog.c` with spaces and puts the result in `prog.notab.c`. Tab positions are at columns 9, 17, 25, 33, and so on. The **-e** flag tells the **pr** command to replace the tab characters; the **-t** flag suppresses the page headings.

- To print a file named `myfile` in two columns, in landscape, and in 7-point text, type:

```
pr -l66 -w172 -2 myfile | qprt -z1 -p7
```

## Printing ASCII files on a PostScript printer

The Text Formatting System includes the **enscript** filter for converting ASCII print files to PostScript files for printing on a PostScript printer.

- The printer must be physically attached to your system.
- The printer must be configured and defined.
- The transcript portion of Text Formatting Services must be installed.

The **enscript** filter is called by the **qprt** -da command when submitting a print job to a PostScript print queue. Several flags may be specified with the **qprt** command to customize the output when submitting ASCII files to a PostScript print queue:

<b>Item</b>	<b>Descriptor</b>
-1+	Adds page headings.
-2+	Formats the output in two columns.
-3+	Prints the page headings, dates, and page numbers in a fancy style. This is sometimes referred to as "gaudy" mode.
-4+	Prints the file, even if it contains unprintable characters.
-5+	Lists characters that are not included in a font.
-h <i>string</i>	Specifies a string to be used for page headings. If this flag is not specified, the heading consists of the file name, modification date, and page number.
-l <i>value</i>	Specifies the maximum number of lines printed per page. Depending on the point size, fewer lines per page might actually be displayed.
-L!	Truncates lines longer than the page width.
-p	Specifies the point size. If this flag is not specified, a point size of 10 is assumed, unless two-column rotated mode ( <b>-2+ -z1</b> ) is specified, in which case a value of 7 is used.
-s	Specifies the font style. If this flag is not specified, the Courier font is used. The PostScript printer must have access to the specified font. Acceptable values are: <div style="margin-left: 2em;">           Courier-Oblique            Helvetica            Helvetica-Oblique            Helvetica-Narrow            Helvetica-Narrow-Oblique            NewCenturySchlbk-Italic            Optima            Optima-Oblique            Palatino-Roman            Palatino-Italic            Times-Roman            Times-Italic         </div>
-z1	Rotates the output 90 degrees (landscape mode).

The following list contains examples of how these **qprt** command flags can be used:

- To send the ASCII file `myfile.ascii` to the PostScript printer named **Msp1**, type:

```
qprt -da -PMsp1 myfile.ascii
```

- To send the ASCII file `myfile.ascii` to the PostScript printer named **Msp1** and print out in the Helvetica font, type:

```
qprt -da -PMsp1 -sHelvetica myfile.ascii
```

- To send the ASCII file `myfile.ascii` to the PostScript printer named **Msp1** and print out in the point size 9, type:

```
qprt -da -PMsp1 -p9 myfile.ascii
```

## Automating the conversion of ASCII to PostScript

You can configure the system to detect ASCII print files submitted to a PostScript print queue and automatically convert these ASCII files to PostScript for a PostScript printer.

Many applications that generate PostScript print files follow the convention of making the first two characters of the PostScript file **%!**, which identifies the print file as a PostScript print file. To configure the system to detect ASCII print files submitted to a PostScript print queue and automatically convert them to PostScript files before sending them to the PostScript printer, perform these steps:

1. At the prompt, type: `smit chpq`
2. Type the PostScript queue name, or use the **List** feature to select from a list of queues.
3. Select the **Printer Setup** menu option.
4. Change the value of **AUTOMATIC detection of print file TYPE to be done?** field to **yes**.

Any of the following commands now convert an ASCII file to a PostScript file and print it on a PostScript printer. To convert `myfile.ascii`, type any of the following at the command line:

```
qprt -Pps myfile.ps myfile.ascii
```

```
lpr -Pps myfile.ps myfile.ascii
```

```
lp -dps myfile.ps myfile.acsii
```

where `ps` is a PostScript print queue.

## Overriding automatic determination of print file types

In some cases, you may need to override the automatic determination of print file types.

You can override the automatic determination of print file type for PostScript printing with the `-d` and `-s` flags. The `-d` flag overrides the default print file type and the `-s` flag specifies PostScript printing.

You might need to override the automatic determination of print file type for PostScript printing in the following situations:

- To print a PostScript file named `myfile.ps` that does not begin with **%!**, type the following command:

```
qprt -ds -Pps myfile.ps
```

- To print the source listing of a PostScript file named `myfile.ps` that begins with **%!**, type the following command:

```
qprt -da -Pps myfile.ps
```

## Command summary for printing

There are a number of commands used for printing and managing print queues.

<b>Item</b>	<b>Descriptor</b>
<b><u>cancel</u></b>	Cancels requests to a line printer.
<b><u>lp</u></b>	Sends requests to a line printer.
<b><u>lpq</u></b>	Examines the spool queue.
<b><u>lpr</u></b>	Enqueues print jobs.
<b><u>lprm</u></b>	Removes jobs from the line printer spooling queue.
<b><u>lpstat</u></b>	Displays line printer status information.
<b><u>pr</u></b>	Writes a file to standard output.

<b>Item</b>	<b>Descriptor</b>
<b><u>qcan</u></b>	Cancels a print job.
<b><u>qchk</u></b>	Displays the status of a print queue.
<b><u>qhld</u></b>	Holds or releases a print job.
<b><u>qmov</u></b>	Moves a print job to another print queue.
<b><u>qpri</u></b>	Prioritizes a job in the print queue.
<b><u>qprt</u></b>	Starts a print job.

## Printing administration

---

When working with printers, system administrators must manage a spooler, real printers, virtual printers, backends, and queues, which are all parts of the printer subsystem.

The system management information associated with printers includes:

### Printing processes

When you print a file, the system sends codes to the printer. Some codes print specific characters, such as specific alphabetic or numeric characters. Other codes control how characters or files are printed, such as by underscoring certain characteristics or by adjusting the page length.

If you want to send different character codes to the printer, such as changing the word **that** to **this**, you do not have to understand the underlying codes; you merely edit the file.

To alter the way a printer works, however, you must understand what happens when you print a file, which options you have for sending control information to the printer, and which printer characteristics you can control.

You can use the System Manager Interface Tool (SMIT), or the **qprt** command to send a file to a printer. In addition, you can use SMIT to cancel or prioritize a print job.

Whichever method you use to print, a file never goes directly to the printer. All three methods first must call the **enq** command to place the print request in a queue. The print request stays in the queue until a printer becomes available, at which point the **qdaemon** command runs the (printer input/output backend) **pio** command. The **pio** command processes the file and sends it, along with control information, to the printer. The printer then receives a data stream containing the contents of the file and the control information specified with the **qprt** command.

### Printing process control

You can add printer control information to the printer data stream in the following ways:

- Include printer control codes in the file.

To do this, set the print queue data stream to **passthru** (that is, **d=p**). For more information, see [“Printer colon file conventions”](#) on page 71.

Include all printer control information that is unique to that file. For example, to underscore the title of a book or print a paragraph in bold type, insert codes that start and stop the printer control information at the correct places.

Some application programs, such as word processors, allow you to insert specific printer controls in the file. However, if the printer cannot be configured from the application program, you must use a system editor to insert printer control codes. Printer control codes are available with the printer, from the dealer where the printer was purchased, or from the printer manufacturer.

- Supply command flags with the **qprt** command.

The **qprt** command or the SMIT **Start a Print Job** option recognizes a number of flags that control printer operations, such as:

- Specifying condensed, emphasized, double-wide, and double-strike printing
- Printing in specified colors
- Setting the margins
- Setting the number of lines per vertical inch
- Maintaining the horizontal position on the print line for a line feed or vertical tab control

You can specify particular print characteristics for a single print job. For example, the **qprt** command flag for setting pitch is `-p Number`, where *Number* is the number of characters per inch. If the standard **qprt** command setting is 10 characters per inch, but you need 12 characters per inch for the `printtest` file, type the command:

```
qprt -p 12 printtest
```

The flag on the command line overrides the standard **qprt** command setting for this job. The standard **qprt** command pitch setting remains 10.

- Change the standard **qprt** command settings.

You can use SMIT or the **lsvirprt** command.

**Note:** You must have root authority or be a member of the **printq** group.

For example, to change the standard pitch to 12 characters per inch, run the **chvirprt** command, or SMIT. Select the printer from the list displayed and type the attribute name and value, separated by the equal sign (=).

The attribute names for the **qprt** command flags are the flag letters. You can change the standard pitch to 12 by specifying `p=12`.

## Initial printer configuration

You can use one process to configure a printer and another process to add a print queue. The task you use depends on how your printer is attached to the system.

You can also configure a printer without adding a print queue.

**Note:** The AIX operating system does not support printers that are attached to your system through a Universal Serial Bus (USB).

The following sections describe how to do these tasks:

### Configuration file modification

You can edit the `/etc/qconfig` file.

Both the **enq** command and the **qdaemon** command read the `/etc/qconfig` file when they start. The **qdaemon** command starts when you start the system; the **enq** command starts each time someone requests a print job. Therefore, if you change the `/etc/qconfig` file, the **enq** command reads the new version of the configuration file the next time it runs.

Do not edit the `/etc/qconfig` file while there are active jobs in any queue. Editing includes both manual editing and use of the **mkque**, **rmque**, **chque**, **mkquedev**, **rmquedev**, or **chquedev** commands. Use these commands when changing the `/etc/qconfig` file unless you want to do manual editing. For manual editing, first issue `enq -G` command to bring the queuing system and the **qdaemon** command down after all jobs are present. Then edit the `/etc/qconfig` file and restart the **qdaemon** command with the new configuration.

### Virtual printers and print queues

A virtual printer is associated with a print queue.

You can define a print queue for each data stream the printer supports. Multiple print queues can use the same real printer.

To add print queues, use the SMIT **Add a Print Queue** option, or the **mkque**, **mkquedev**, and **mkvirprt** commands.

When you submit a print job, a print queue must be directly or indirectly specified. To specify a specific printer for a print job, add a colon and the printer device name to the print queue name. If a printer is not specified for the print job, the spooler selects the first available printer associated with the print queue. If there are several printers associated with a print queue, any printer is used.

IBM® Proprinters, for example, need only one print queue to be defined for each real printer. This is because Proprinters support only one data stream: IBM extended ASCII. The IBM 4216 Model 031 Personal Pageprinter needs multiple print queues defined. A print queue can be defined for each data stream the printer supports. A print queue can be defined for PostScript, Proprinter, HP LaserJet, and Diablo 630 emulations. All four print queues output to the same real printer, the 4216 Model 031.

## Configuring a local printer and adding a queue

You can use SMIT to configure a local printer and add a queue.

- Read the documentation for your printer. You might need printer-specific information to connect and configure the printer.
- Review the configuration of your system. Determine the parallel or serial port you want to connect the printer.
- You must have root authority.

**Note:** The AIX operating system does not support printers that are attached to your system through a Universal Serial Bus (USB).

Use the following procedure if you want to configure a local printer in addition to spooling print jobs.

1. Connect the printer directly to the serial or parallel port on the local host:
  - a. Use the **shutdown** command at the system prompt to halt the system.
  - b. Turn off the system and any external devices.
  - c. Connect the printer to the appropriate serial or parallel port.
  - d. Set up your printer as described in the printer documentation.
  - e. Restart the system.
2. At the system prompt, type **smit chpq** and then follow the instructions to complete the task.

## Configuring a remote printer and adding a queue

You can configure a remote printer and add a queue.

The remote host must be configured as a print server.

Use the following procedure if you want to configure a remote printer in addition to spooling print jobs.

**Note:** If you want to configure a printer without adding a print queue, see [“Configuring a printer without adding a queue \(SMIT\)” on page 17](#) and [“Configuring a printer without adding a queue \(qprt command\)” on page 17](#).

1. At the system prompt, type **smit mkpq** and then follow the instructions to complete the task.
2. After the print queues are successfully created, their names are displayed. Be sure to note any error messages before you exit.
3. Use the **smit chpq** to customize the new print queue.

## Configuring a network printer and adding a queue

You can configure a network printer and add a queue.

- Read the documentation for your printer. You might need printer-specific information to connect and configure the printer.

- Read the documentation for the Hewlett-Packard JetDirect card.
- You must have root authority.

Use the following procedure if you want to configure a network printer in addition to spooling print jobs.

1. At the system prompt, type **smit mkpq** and then follow the instructions to complete the task.
2. After the print queues are successfully created, their names are displayed. Be sure to note any error messages before you exit.
3. Use the **smit chpq** to customize the new print queue.

## Configuring a print queue for a file in the /dev directory

You can configure a print queue for a file in the /dev directory.

- Read the documentation for your printer. You might need printer-specific information to connect and configure the printer.
- Review the configuration of your system.
- You must have root authority.

Use the following procedure if you want to configure a print queue for a file in the /dev directory.

1. At the system prompt, type **smit mkpq** and then follow the instructions to complete the task.
2. After the print queues are successfully created, their names are displayed. Be sure to note any error messages before you exit.
3. Use the **smit chpq** command to customize the new print queue.

## Configuring a printer without adding a queue (qprt command)

You can use the **qprt** command to add a printer or plotter without adding a queue if you do not want to spool print jobs for the printer or plotter.

The printer or plotter must be physically attached to your system before configuring the printer port.

Use the following procedure if you want to add a printer or plotter, but you do not want to spool print jobs.

**Note:** If you also want to add print queues when you configure your printer, see [“Initial printer configuration”](#) on page 15.

The following example describes how to queue a print job using the **qprt** command, the **enq** command, the **lp** command, or the **lpr** command. The syntax is the same for all three queuing commands, except that the **-d** flag (instead of the **-P** flag) should be specified with the **lp** command:

```
Command -P QueueName FileName
```

where:

### QueueName

Name of the print queue.

### FileName

Name of the file to be printed.

The following example demonstrates how to use the **qprt** command:

```
qprt -Pfastest myfile
```

See the individual queuing commands for additional flags that can be specified.

## Configuring a printer without adding a queue (SMIT)

You can use SMIT to add a printer or plotter without adding a queue if you do not want to spool print jobs for the printer or plotter.

The printer or plotter must be physically attached to your system before configuring the printer port.

Use the following procedure if you want to add a printer or plotter, but you do not want to spool print jobs.

**Note:** If you also want to add print queues when you configure your printer, see [“Initial printer configuration”](#) on page 15.

1. At the system prompt, enter:

```
smit pdp
```

2. Select **Add a Printer/Plotter**.
3. Provide additional information as prompted.

## Print queue operations

There are several procedures related to print queue operations.

This section describes the following procedures:

### Adding a print queue device

You can add a print queue device.

To perform this task, you must have root authority.

Use the following procedure to add a print queue device.

At the system prompt, enter **smit mkquedev** and then follow the instructions to complete the task.

- You can also add a print queue device with the **mkquedev** command:

```
mkquedev -d QueueName -q QueueName -a Attribute = Value
```

You might need to use the **-a** flag several times to fully configure a print queue device.

### Adding plotter support with 5080

A procedure for adding plotter support is described.

- The plotter must be physically attached to your system.
- The plotter device must have already been added.

Use the following procedure to add plotter support. The 5080 Attachment Adapter plotter backend is accessible with the **enq** command after you use this procedure to identify the plotters:

1. At the system prompt, type: `smit pq_mk1que`
2. At the **NAME of Queue to Add** prompt, type: `plta`  
to define serial port **a**.
3. At the **NAME of Device to Add** prompt, type: `plota`  
to define serial port **a**.
4. For **BACKEND PROGRAM Pathname**, type: `/usr/lib/lpd/plotgbe -gswa 9600`.
5. At the **NAME of Queue to Add** prompt, type:

```
pltb
```

to define serial port **b**.

6. At the **NAME of Queue to Add** prompt, type: `pltb`  
to define serial port **b**.
7. For **BACKEND PROGRAM Pathname**, type: `/usr/lib/lpd/plotgbe -gswa 9600`
8. Attach the plotter to either port **a** or port **b**.

You can also perform this task with the **mkque** and **mkquedev** commands. Additional flags are required to add plotter support. See the [mkque](#) and [mkquedev](#) commands for more information.

## Creating a plotter setup file

To send plot files to the plotter, you need a special file containing the instructions for the type of pacing protocol you are using.

The following instructions set the Xon/Xoff Pacing Protocol and Data Transmit Rate (DTR) Pacing Protocol:

<b>For Xon/Xoff Pacing</b>	<b>For DTR Pacing</b>
ESC.R:	ESC.R:
ESC.M2:	ESC.M2:
ESC.N2:	ESC.N2:
ESC.P1:	ESC.P3:

Each line must be entered with no spaces, ESC has the ASCII value 27. The . (period) is part of the command.

## Adding a local printer to an existing queue

You can add a local printer to an existing queue.

To perform this task, you must be one of the following people:

- User with root authority
- Member of the **printq** group

Use the following procedure to add a local printer to an existing queue.

At the system prompt, type **smit mkpprt**, and then follow the instructions to complete the task.

## Adding an ASCII terminal printer to an existing queue

You can add an ASCII terminal printer to an existing queue.

To perform this task, you must be one of the following people:

- User with root authority
- Member of the **printq** group

Use the following procedure to add an ASCII terminal printer to an existing queue.

1. At the system prompt, type: **smit mkpprt**
2. Select the **ascii** attachment type, manufacturer, printer model, and tty name.
3. Provide additional information as prompted.

## Adding an HP JetDirect printer to an existing queue

You can add an HP JetDirect printer to an existing queue.

To perform this task, you must be one of the following people:

- User with root authority
- A member of the **printq** group

Use the following procedure to add an HP JetDirect printer to an existing queue.

1. At the system prompt, type **smit mkpprt** , and then follow the instructions to add the printer.
2. Provide additional information as prompted.

## Adding a file to an existing queue

You can add a file to an existing queue.

To perform this task, you must be one of the following people:

- User with root authority
- Member of the **printq** group

Use the following procedure to add a file to an existing queue.

1. At the system prompt, type: `smit mkppprt`.
2. Select the **file** attachment type, manufacturer, and model.
3. Enter a file name in the **Name of existing FILE** in the /dev directory. This is the file where you want print job output to be stored. The file must already exist and be located in the /dev directory.
4. Provide additional information as prompted.

## Configuration of nonsupported printers

A nonsupported printer is a printer for which a printer driver is not supplied with the operating system. You can configure a nonsupported printer.

There are several methods for configuring a nonsupported printer. You must define a virtual printer to support the features of the nonsupported printer and the print spooling subsystem. You may also need to adapt your nonsupported printer so that it functions properly with the base operating system serial printer device driver.

### Configuration options for nonsupported printers

You can configure your printer and change the virtual printer characteristics to accommodate your printer.

Choose one of the following methods to configure and use a nonsupported printer:

- If the nonsupported printer uses the same hardware interface (serial or parallel) and closely approximates the functions of a supported printer, you can configure the device as a supported printer.
- If there are no supported printers that are similar to your printer, you can configure your printer as a supported printer. Change the virtual printer characteristics to accommodate your printer.
- If you are not sure if your printer emulates a supported device, use **generic** as the printer type and the appropriate interface type. The operating system supplies two generic devices: other parallel printer (**opp**) and other serial printer (**osp**). Specify one of these devices by selecting the interface type, such as **parallel rs232**, and modify the characteristics according to the specifications in your printer manual.
- If you want the print spooling subsystem available for sharing the printer among users, but do not need the virtual printer system to format the data stream, you can configure your printer device driver and print queue, but set the print subsystem to pass all print requests transparently to the printer. With this configuration the application must correctly assemble the printer data stream.
- If your output device has special formatting requirements, such as an electrostatic plotter that requires input as raster graphics, substitute the formatting software for the printer formatter or the printer backend program.

### Customizing nonsupported virtual printers

You must define a virtual printer to support the features of the nonsupported printer and the print spooling subsystem.

Perform the following steps to define a virtual printer:

1. Identify the printer data stream that best matches your printer to customize a nonsupported printer. The operating system supports the following data streams through predefined virtual printers:

<b>Item</b>	<b>Descriptor</b>
<b>asc</b>	Extended ASCII
<b>pcl</b>	Hewlett-Packard LaserJet
<b>gl</b>	Plotter
<b>ps</b>	PostScript
<b>630</b>	Diablo 630
<b>855</b>	Texas Instruments 855 dot matrix printer in dp mode

2. After you have identified the data stream used by your printer, select either a supported printer that uses the same data stream or one of the generic printers, and customize the definition for your printer.

## Wiring nonsupported printers

You might need to adapt your nonsupported printer so that it functions properly with the base operating system serial printer device driver.

The following table details what the RS-232 signals mean to the serial printer device driver:

<b>RS-232 Signal</b>	<b>Serial Printer Device Driver Use</b>
FG	Frame ground. Often used as shield.
TxD →	Used to transmit data to printer.
RxD ←	Used to receive data from printer.
RTS ←	Held high after printer port opened. Provides host status to printer. Not used for data pacing.
CTS ←	Must be high for printer port to be opened. Used to detect that the printer is turned on.
DSR	Not used. Usually tied to DCD.
SG	Reference voltage for signals.
DCD ←	Used for data pacing when DTR is set to <b>yes</b> .
DTR →	Held high after printer port opened. Provides host status to printer.

1. If you use FG as a cable shield, make sure that it is connected only at one end. It makes no difference which end is connected. This provides an efficient shield against electrical noise.
2. If your RTS signal is used to supply voltage to CTS on the printer port, check to see what your printer does with its RTS signal.

Although RTS and CTS data pacing is not supported on serial printers, the device driver will block the open of the printer port until the voltage of CTS becomes high. The CTS signal is usually supplied by the RTS signal from the printer. However, some printers use the RTS signal for data pacing. These printers drop RTS when they want the system to stop sending data. Because the queuing system always needs the port opened to check for status, if the printer drops the RTS signal, the port closes and the queue goes down.

3. Some printers require that you raise the voltage of DCD and DSR or CTS on the printer side. If your printer requires that these voltages be raised, use one of the following methods for raising the voltage:
  - a. Use DTR or RTS on the computer side to supply the voltage.

OR

  - b. Obtain the voltage from the printer side.

## Printing with terminal-attached printers

Many asynchronous ASCII terminals have an auxiliary (AUX) port that can be used to connect a printer. Terminal-attached printing is supported for terminals attached directly to a host machine or attached remotely by modem to a host machine.

This section discusses configuration, maintenance, and problem determination for terminal-attached printers, as well as the following topics:

### Installing a terminal-attached printer

Before you can use a terminal-attached printer, you must install the printer and configure it into the print spooling subsystem.

To install a new terminal-attached printer and configure it into the print spooling subsystem, perform the following steps.

1. Install the physical ASCII terminal (tty) device and connect it to the system. See [“Installing a physical ASCII terminal”](#) on page 22.
2. Configure a tty device driver for the ASCII terminal. See [“Configuring the terminal device driver \(tty\)”](#) on page 22.
3. Verify terminal output. See [“Verifying terminal output”](#) on page 22.
4. Connect the serial printer to the AUX or PRINT port of your ASCII terminal. See [“Installing a physical printer”](#) on page 23.
5. Configure a virtual printer and print queue. See [“Configuring a virtual printer and print queue”](#) on page 23.
6. Establish a queue for a modem line. See [“Configuring a queue for modem connections”](#) on page 23.

### Installing a physical ASCII terminal

Before you can use a physical ASCII terminal, you must install the terminal.

You should perform the following steps to install a physical ASCII terminal:

1. Review all relevant installation planning information and the terminal's documentation to ensure that you have the components required for installation.
2. Review your system's configuration, and select the serial port.
3. Ensure that the communications port is not in use.
4. Connect the terminal to the serial communications port. Be sure to use proper cabling. Consult your documentation for cabling instructions.
5. Configure the terminal according to the documentation provided with it. Be sure to record the settings you choose for baud rate, stop bits, bits per character, and flow control. You need this information to configure the base operating system tty device driver.

### Configuring the terminal device driver (tty)

You must configure the terminal device driver (tty) before you can use the associated terminal.

To configure the **tty**:

1. Log in as the root user.
2. At the system prompt, type **smit tty** command and then follow the instructions to complete the task.

### Verifying terminal output

After a terminal device has been configured, you should verify that the terminal is working.

Use the following command to verify that the terminal is working and to send output directly to the terminal screen:

```
cat /etc/qconfig > /dev/ttynn
```

where *nn* is the appropriate tty device number. The contents of the `/etc/qconfig` file should appear on the terminal screen.

### ***Installing a physical printer***

Before you can use a physical printer, you must install the printer.

Perform the following steps to install a physical printer.

1. Review all relevant installation planning information and the printer's documentation to ensure that you have the required components and information to install the printer.
2. Review the terminal documentation for information on connecting printers to the auxiliary (AUX) port.
3. Verify that the AUX port on the terminal is configured with the same settings as your printer, such as baud rate, parity, data bits, stop bits, and XON/XOFF.
  - For information about setting values for the AUX port, consult your terminal documentation.
  - For information about configuring the printer's serial interface, consult your printer documentation.
4. Connect the printer to the terminal's AUX port. Be sure to use the proper cabling. Consult your documentation for cabling instructions.

### ***Configuring a virtual printer and print queue***

Before you can use a virtual printer and print queue, you must configure the virtual printer and print queue.

To configure your terminal-attached printer into the print spooling subsystem:

At the system prompt, type **smit mkpq** and then follow the instructions to complete the task.

You can also perform this procedure with the **piomkpq** command.

### ***Configuring a queue for modem connections***

You can configure a queue for modem connections.

Terminal-attached printing can also be supported by establishing a queue for a modem line instead of creating the queue for a specific terminal. Because the terminal type of a dial-in terminal cannot be guaranteed, set the **PIOTERM** environment variable to the terminal type of the dial-in terminal by typing the following command:

```
export PIOTERM=Dialin-Terminal-Type
```

### **Configuring a printer for an ASCII display terminal**

You can configure a printer for an ASCII display terminal.

The following prerequisites must be true to configure a printer for an ASCII display terminal:

- You must have connected a serial printer to the AUX or PRINT port on your ASCII terminal. See the terminal documentation for cabling instructions.
- The tty device for the ASCII terminal must be defined.
- The printer must be online.
- Verify that the AUX port on the terminal is configured with the same settings as your printer. To do this, consult your terminal documentation for information about setting values for the AUX port. Consult your printer documentation for information about configuring the printer serial interface.
- You must have root user authority.

To configure a printer for an ASCII display terminal:

1. At the system prompt, type:

```
smit mkpq
```

2. Select the **ascii** attachment type, manufacturer, and printer model.

3. Provide additional information as prompted.

You can also perform this task with the **piomkpq** command.

## Terminal-attached printing limitations

Consider the following limitations when configuring terminal-attached printers.

1. Send only ASCII data to the printer. Binary data can inadvertently lock the terminal or cause printing to cease prematurely.
2. Printer status messages that indicate conditions such as out of paper and printer offline are not supported.

## Supported hardware for terminal-attached printers

A list of supported hardware for terminal-attached printers is provided.

The following hardware is supported for terminal-attached printing:

- Cables
  - RS-232
  - RS-422
- Terminal Devices
  - IBM 3151, 3161, 3162, 3163, 3164
  - DEC VT100, VT220, VT320, VT330
  - WYSE 30, 50, 60, 350
- Printers
  - IBM 2380 Personal Printer II
  - IBM 2381 Personal Printer II
  - IBM 2390 Personal Printer II
  - IBM 2391 Personal Printer II
  - IBM 2380 Personal Printer II (Model 2)
  - IBM 2381 Personal Printer II (Model 2)
  - IBM 2390 Personal Printer II (Model 2)
  - IBM 2391 Personal Printer II (Model 2)
  - IBM 3112 Page Printer
  - IBM 3116 Page Printer
  - IBM 3130 LaserPrinter
  - IBM 4019 LaserPrinter
  - IBM 4029 LaserPrinter
  - IBM 4037 LaserPrinter
  - IBM 4039 LaserPrinter
  - IBM 4076 InkJet Printer
  - IBM 4201 Model 3 Proprinter III
  - IBM 4202 Model 3 Proprinter III XL
  - IBM 4207 Model 2 Proprinter X24E
  - IBM 4208 Model 2 Proprinter XL24E
  - IBM 4247 Printer
  - IBM 5204 Quickwriter

- IBM 6400 Printer
- IBM InfoPrint 40 Printer
- IBM Network Color Printer
- IBM Network Printer 12
- IBM Network Printer 17
- IBM Network Printer 24
- Hewlett-Packard 2500C Color Printer
- Hewlett-Packard LaserJet II
- Hewlett-Packard LaserJet III
- Hewlett Packard LaserJet IIISi
- Hewlett-Packard LaserJet 4
- Hewlett Packard LaserJet 4Si
- Hewlett Packard LaserJet 4 Plus
- Hewlett Packard LaserJet 4V
- Hewlett-Packard LaserJet 5000 D640 Printer
- Hewlett Packard LaserJet 5Si/5Si MX
- Hewlett Packard LaserJet 5Si Mopier
- Hewlett-Packard LaserJet 8000 Printer
- Hewlett-Packard LaserJet 8100 Printer
- Hewlett Packard LaserJet Color
- Hewlett-Packard Color LaserJet 4500
- Hewlett-Packard Color LaserJet 8500
- Lexmark Optra LaserPrinter
- Lexmark Optra E310 LaserPrinter
- Lexmark Optra M410 LaserPrinter
- Lexmark Optra Se LaserPrinter
- Lexmark Optra TLaserPrinter Family
- Lexmark Optra W810 LaserPrinter
- Lexmark Optra Plus LaserPrinter
- Lexmark Optra C Color LaserPrinter
- Lexmark Optra E LaserPrinter
- Lexmark Optra N LaserPrinter
- Lexmark ExecJet IIc
- Lexmark ValueWriter 600
- Lexmark 2380 Plus Printer (Model 3)
- Lexmark 2381 Plus Printer (Model 3)
- Lexmark 2390 Plus Printer (Model 3)
- Lexmark 2391 Plus Printer (Model 3)
- Lexmark 4039 Plus LaserPrinter
- Lexmark 4079 Color JetPrinter Plus
- Lexmark 4227 Forms Printer
- Asynchronous Communications Adapters
  - Native serial port controller

- 8-port controller
- 16-port controller
- 64-port controller
- 128-port controller
- Third-party controller

**Note:** Third-party asynchronous controllers are also supported. When the base operating system detects that an ASCII terminal was configured with a third-party controller, the terminal-attached printer is configured as though it was connected to the native port controller. For more information, see [“Native, 8-port, 16-port, and third-party controllers”](#) on page 27.

For more information about certain Lexmark printers in the preceding list, see the following sections:

- [“IBM InfoPrint 40 Printer”](#) on page 153
- [“Lexmark Optra E310 Laser Printer”](#) on page 194
- [“Lexmark Optra M410 Laser Printer”](#) on page 196
- [“Lexmark Optra Se Laser Printer”](#) on page 199
- [“Lexmark Optra T Laser Printer Family”](#) on page 202
- [“Lexmark Optra W810 Laser Printer”](#) on page 206

## terminfo database

The print service relies on the standard interface script and the **terminfo** database to initialize each printer and set up a selected page size, character pitch, line pitch, and character set.

Thus, it is usually sufficient to have the correct entry in the **terminfo** database (`/usr/lib/terminfo/terminfo.lp`) to add a new printer to the print service.

The **terminfo** database identifies each printer by a short name, identical to the kind of name used to set the **TERM** shell variable. For example, the name in the **terminfo** database for the AT&T model 455 printer is **455**.

To specify the **terminfo** type for your printer, use the `-T` option of the **lpadmin** command. By default, the **terminfo** database includes entries for many popular printers. Select the **terminfo** type that corresponds to your printer.

If **terminfo** does not include an entry for your printer, you might still be able to use the printer with the print service. However, you will not be able to use automatic selection of page size, pitch, and character sets, and you might have trouble keeping the printer set to the correct modes for each print request or using printer forms with the printer. In this case, you can either add an entry to *terminfo* ([“Adding a printer entry to the terminfo database”](#) on page 225) for your printer or create a customized interface program ([“Creating printer interface scripts”](#) on page 222) to use with the printer.

You can define hundreds of items for each terminal or printer in the **terminfo** database. However, the print service uses fewer than 50 of these, and most printers need even less than that. You can check items defined for a specific **terminfo** entry by entering the following command:

```
infocmp terminfo_name
```

## Adding support for non-supported terminals

You can add control sequences for non-supported terminals to the **terminfo** database.

The control sequences must be added to the **terminfo** database in the `/usr/share/lib/terminfo` directory. To add the control sequence values for your terminal:

1. Edit the appropriate `*.ti` file.
2. Compile the file using the **tic** command. For more information about control sequence values, see the documentation supplied with your terminal.

The *virtual printer database* is a series of files that describe the way print requests should be processed, such as the data stream to be delivered to the printer. User-configurable attributes specific to terminal-attached printers are defined in the virtual printer database and are based upon the asynchronous communications adapter being used.

The *virtual printer attributes* are defined when the virtual printer is configured. The naming convention for attributes unique to terminal-attached printers is **yN**, where *N* is an integer greater than or equal to 0. The value of **y0** is reserved. It designates that the virtual printer queue is configured for a terminal-attached printer and contains the hardware line discipline for the terminal port. The sections that follow detail the adapter-specific virtual printer attributes for terminal-attached printers.

To change the attribute values on an existing virtual printer, use the **smit ps\_lsvirprt** fast path command.

## Native, 8-port, 16-port, and third-party controllers

Native port (S1 or S2), 8-port, and 16-port controllers do not provide hardware support for terminal-attached printers, and the hardware support for third-party controllers is unknown. As a result, print files must be split into small data blocks.

The **mc5** control sequence precedes each data block, which is in turn followed by the **mc4** control sequence. When the terminal receives the **mc5** control sequence, all subsequent data is routed to the AUX port until an **mc4** control sequence is received.

Data blocks sent to the terminal must be kept relatively small. Sending too many characters to the tty at once can cause output to the printer to be mixed with the echo of what is typed during the sending operation. A delay time between data block transmissions must also be established to minimize data reception errors.

Native port, 8-port, 16-port, and third-party controllers have the following virtual printer attributes for specifying block size and delay value. These attributes are specified in a file.

### Ite

#### m Descriptor

**y1** Indicates the maximum number of characters in a data block.

**y2** Indicates the number of microseconds to delay between data block transmissions.

## 64-port controller

The 64-port controller provides hardware support for terminal-attached printers.

The 64-port controller has the following virtual printer attribute:

### Ite

#### m Descriptor

**y1** Sets the priority with which printing will be done over terminal activity. The larger the number, the greater the priority the printer has over the terminal.

## 128-port controller

The 128-port controller also provides hardware support for terminal-attached printers.

The 128-port controller has the following virtual printer attributes:

### Ite

#### m Descriptor

**y1** Sets the maximum characters per second (CPS) rate at which characters are sent to the print device. The rate should be just below the average print speed for your printer. Consult your printer's documentation for print speed.

## Item

### Descriptor

- y2** Sets the maximum number of print characters the device driver places in the output queue. Reducing this number increases system overhead. Increasing this number delays operator keystroke echo times when the terminal-attached printer is in use.
- y3** Sets the device driver estimate of the size of the terminal-attached printer's input buffer. After a period of inactivity, the driver bursts the designated number of characters to the printer. Consult your printer's documentation for input buffer size.

## Printer backend commands

The **piobe** command is the normal backend program run by the print spooling subsystem when printing to a locally attached printer device.

The **piobe** command is started by the **qdaemon** process. It determines the data stream it is going to create by reading a flag or querying the virtual printer database. The **piobe** process then passes the print file through a pipeline of appropriate filters so that it generates the correct data stream. At the end of this pipeline, the filtered file is passed to the **pioout** device driver interface program.

The **pioout** command is invoked in a pipeline by the **piobe** command. For locally attached printers, the **pioout** command sends the print file to the appropriate printer device driver (for example, `/dev/lp1`). However, for terminal-attached printers, the print files are sent to the printer through the tty device driver (for example, `/dev/tty0`), after being modified by data gathered from the terminfo and virtual printer databases. The **terminfo** database is queried for the **mc5** and **mc4** terminal control attributes. The virtual printer database is queried for the asynchronous controller-specific attributes.

## Listing print queues

You can list print queues with the **lsallq** command, or SMIT.

- For local print queues, the printer devices must be attached to your system.
- For remote print queues, your system must be configured to communicate with a remote host.

The following procedures apply to both local and remote print queues.

At the system prompt, type **smit lspq** and then follow the instructions to complete the task.

You can also perform this task with the **lsallq** command.

## Showing status of print queues

You can view the status of print queues with the **enq** command, or with SMIT.

You can view the status of print queues with the SMIT interface.

At the system prompt, type **smit qstatus**.

You can also perform this task with the **enq -e "\$@"** command.

## Starting and stopping a print queue

You can start and stop a print queue if you have root authority.

To perform these tasks, you must have root authority.

To start a queue:

```
smit qstart
```

OR

```
qadm -U QueueName
```

To stop a queue:

```
smit qstop
```

OR

```
qadm -D QueueName
```

## Setting the default print queue

You can set the default print queue with the SMIT.

To perform this task, you must be one of the following people:

- A user with root authority
- A member of the `printq` group

To set the default print queue:

At the system prompt, type **smit qdefault** and then follow the instructions to complete the task.

## Scheduling print jobs

You can use the SMIT fast path to schedule print jobs.

To schedule print jobs, your root user login name must be included in the `/var/adm/cron/at.allow` file, or you must have root user authority.

- To list all scheduled print jobs, type the following command at the system prompt:

```
smit lsat
```

This command displays a list of all the print jobs you have scheduled. If you have root user authority, the command lists all currently scheduled print jobs.

- To schedule print jobs:

1. Type the following command at the system prompt:

```
smit sjat
```

2. Select or enter the appropriate date and time fields.
3. Provide additional information as prompted.

- To remove a scheduled job, type the following command at the system prompt:

1. Type the following:

```
smit imat
```

2. Select **List** to delete the job number.

## Changing or showing queue characteristics

You can display and change queue characteristics for local and remote print queues and print queue devices.

The following prerequisites must be true to change or display queue properties:

- For local print queues, the printer must be physically attached to your system.
- For remote print queues, your system must be configured to communicate with the remote print server.
- To change queue or queue device characteristics, you must have root authority.

The following procedures apply to both local and remote print queues and print queue devices.

At the system prompt, type **smit chpq** and then follow the instructions to complete the task.

You can also perform this procedure with the **chque**, **chquedev**, **lsvirprt**, and **chvirprt** commands.

## Deleting a print queue

You can delete local and remote print queues.

- For local print queues, the printer must be physically attached to your system.
- For remote print queues, your system must be configured to communicate with the remote print server.
- To delete a queue or queue device, you must have root authority.

To delete a local or remote print queue:

At the system prompt, type **smit rmpq** and then follow the instructions to complete the task.

**Note:** If the selected queue has only one printer, the queue and its printer are removed. If the queue has more than one printer, only the selected printer is removed.

You can also use the **rmque**, **rmquedev**, and **rmvirprt** commands to perform this task.

## Performing other printer administration tasks

You can manage and change printer properties.

This section includes the following topics:

### Listing all supported printers

You can list all supported printers with the SMIT.

At the system prompt, type the **smit lssprt** fast path command.

Output similar to the following example is displayed:

```
bull1021    parallel Bull Compuprint Page Master 1021
.
.
ibm2380     parallel IBM 2380 Personal Printer II
ibm2380     rs232     IBM 2380 Personal Printer II
ibm2380     rs422     IBM 2380 Personal Printer II
.
.
opp         parallel Other parallel printer
osp         rs232     Other serial printer
osp         rs422     Other serial printer
```

### Listing all defined printers

You can list all defined printers with SMIT.

At the system prompt, type the **smit lsdprt** fast path command.

Output similar to the following example is displayed:

```
lp0 Available 00-04-01-06 Other serial printer
lp1 Available 00-04-01-07 Other serial printer
lp2 Available 00-00-0P-00 Other parallel printer
```

## Deleting printers

You can remove a printer from the system.

- A printer must have been added. See [“Configuring a printer without adding a queue \(SMIT\)” on page 17](#) and [“Configuring a printer without adding a queue \(qprt command\)” on page 17](#).

- You must have root authority.

Deleting a printer does not remove any print queues that send print jobs to that printer. If you want to also delete the print queues, see [“Deleting a print queue”](#) on page 30.

To remove a printer using the SMIT:

At the system prompt, type **smit rmpri** and then follow the instructions to complete the task.

## Showing status of printer server subsystem

You can show the status of the print server subsystem with SMIT.

1. At the system prompt, type:

```
smit server
```

2. Select **Show Status of the Print Server Subsystem**.

### *Printer queuing system status conditions*

If a printer or device is added as a tty device, the queuing system looks for carrier detect (CD) to recognize the printer. If the device is an LP device, the queuing system uses CTS to detect the printer.

The following list identifies print queue status conditions:

<b>Item</b>	<b>Descriptor</b>
<b>DEV_BUSY</b>	<p>Identifies the following conditions:</p> <ul style="list-style-type: none"> <li>• More than one queue is defined to a printer device (<b>lp0</b>), and another queue is currently using the printer device.</li> <li>• <b>qdaemon</b> attempted to use the printer port device (<b>lp0</b>), and another application is currently using that printer device. See the <a href="#">qdaemon</a> command for more information.</li> </ul> <p><b>Normal recovery:</b> To recover from a <b>DEV_BUSY</b>, wait until the queue or application has released the printer device, or kill the job or process that is using the printer port.</p>
<b>DEV_WAIT</b>	<p>Indicates that the queue is waiting for the printer because the printer is offline, out of paper, jammed, or the cable is loose, bad, or wired incorrectly.</p> <p><b>Normal Recovery:</b> To recover from a <b>DEV_WAIT</b>, you must correct the problem that caused it to wait. Check to see if the printer is offline, out of paper, jammed, or loosely cabled. It might be easier for diagnostic testing to use the <b>enq</b> command to move all queued jobs from the <b>DEV_WAIT</b> queue to another queue that is either printing or is <b>DOWN</b>. After the problem is corrected, you can move any unprinted jobs back to the original queue.</p> <p><b>DEV_WAIT</b> can also be caused by improper flow control to the printer, particularly when using XON/XOFF software control. Use SMIT to see if you are using the proper flow control (XON/XOFF or DTR pacing).</p> <p>Bad or improperly wired cabling can cause a <b>DEV_WAIT</b> situation. Usually, you cannot recover from this situation unless you replace the cable.</p>

<b>Item</b>	<b>Descriptor</b>
<b>DOWN</b>	<p>Specifies that the device driver cannot communicate with the printer (CD or CTS dropped or is low) after <b>TIMEOUT</b> seconds. The <b>TIMEOUT</b> value indicates the amount of time, in seconds, that the queuing system waits for a printer operation to complete. You can set this value using SMIT.</p> <p>A queue usually goes into the <b>DOWN</b> state after it has been in the <b>DEV_WAIT</b> state. If a queue goes directly into the <b>DOWN</b> state, either the <b>TIMEOUT</b> value is too small or there are cabling problems. Usually, this situation occurs when the printer device driver cannot tell if the printer is there because of the absence of correct signaling. However, some printers cannot signal the queuing system that they are only offline. These printers signal that they are off; they drop CTS (if an lp) or drop CD (if a tty).</p> <p>If the printer device is off, the queue goes into the <b>DOWN</b> state. The system administrator can bring a queue to the <b>DOWN</b> state for maintenance with the queuing commands (<b>qadm</b>, <b>disable</b>, <b>enq</b>, and others).</p> <p><b>Normal recovery:</b> Correct the problem that brought the queue down and bring the queue back up using the <b>qadm</b>, <b>enable</b>, or <b>enq</b> commands with appropriate flags. The queue must be manually brought up before it can be used again.</p>
<b>HELD</b>	<p>Specifies that the job is held and will not be put on the queue until it is released using the <b>qhld</b> or <b>enq</b> commands.</p>
<b>OPR_WAIT</b>	<p>Specifies that the backend program is waiting for the operator to perform a task, such as loading paper. This is usually software-related.</p> <p><b>Normal Recovery:</b> To recover from an <b>OPR_WAIT</b> state, respond appropriately to the request that is made by the queuing system.</p>
<b>QUEUED</b>	<p>Specifies that a print file is queued and is waiting in line to be printed.</p>
<b>READY</b>	<p>Specifies that everything involved with the queue is ready to queue and print a job.</p>
<b>RUNNING</b>	<p>Specifies that a print file is printing.</p>
<b>UNKNOWN</b>	<p>Specifies that a user created a queue on a device file that another queue is using and that the status is <b>DEV_WAIT</b>. The queue cannot get a status from the printer device (lp0) when it is on hold (<b>DEV_WAIT</b>).</p> <p><b>Normal recovery:</b> To correct this, bring down the other queue or fix the problem with the printer. Bring the new queue down and back up so the queue registers as <b>READY</b>.</p>

The following status conditions apply to remote queues:

<b>Item</b>	<b>Descriptor</b>
<b>CONNECT</b>	Specifies that the backend is trying to connect to the remote host.
<b>GET_HOST</b>	Specifies that the backend is getting the host to which the print job will be sent.
<b>INITING</b>	Specifies that the backend is in the process of establishing a connection to the network.

Item	Descriptor
<b>SENDING</b>	Specifies that the backend is sending the print job to the remote host.

## Remote printing

Remote printing allows different computers to share printers.

To use remote printing facilities, the computers must be connected through the Transmission Control Protocol/Internet Protocol (TCP/IP) and must support the required TCP/IP applications, such as the **lpd** daemon.

A remote print request is queued in the same manner as a local print request:

- A front-end print command such as **qprt**, **lpr**, or **enq** initiates the request to the appropriate queue on the local system.
- The **qdaemon** on the local system processes the request as it would any locally queued job, with one exception: the **qdaemon** passes the request to the **rembak** backend program rather than the **piobe** backend.
- The **rembak** program transmits the print job to a remote server over the TCP/IP network.
- On the remote server, the **lpd** daemon monitors port 515 for remote print requests.
- When the **lpd** receives a remote print request, it places the job in the appropriate local queue.
- The print request is then processed by the **qdaemon** on the print server.
- The **qdaemon** passes the request to the **piobe** backend on the print server.
- The **piobe** backend formats the data stream for printing on the specified printer.

The following sections discuss how to configure, use and manage a remote printing environment:

### rembak program

The local queue set up to serve remote print requests must be configured to use **rembak**, the remote print backend command.

When you set up the queue, the system prompts for a backend program path name. The entry at this prompt tells the **qdaemon** command which backend program to use to process print requests. To set up a queue to handle remote print requests, type `/usr/lpd/rembak`.

The **rembak** command also processes status requests, job cancel requests, and requests to kill a remote queuing system. Status requests such as **qchk -A** or **lpstat** query the status of local print queues and devices by analyzing the `qconfig` file and the local print spooling subsystem status files.

In a remote print environment, the **qchk -A** and **lpstat** commands use the **rembak** program to request queue status information from the print servers. The output of a queue status command shows two entries for each remote queue. The first entry is the status of the local queue to which remote jobs are sent. The second entry shows the status of the queue on the remote print server where the jobs are printed. In the following example, the queue name **rq** was used for both the queue on the local system and the queue on the remote print server:

Queue	Dev	Status	Job Files	User	PP	%	Blks	Cp
Iago	Iago	RUNNING	284 mileaf	ann@arctur	15	13	1	1
Pro	asc	READY						
bsh	bshde	READY						
ps	ps	READY						
rq	rqd	READY						
rq	ps1	RUNNING	297 .deskprint/dsktop	sarah@alde	60	22	1	1
		QUEUED	298 .deskprint/howtol	sarah@alde		60	1	2

As the preceding example shows, any print jobs currently running or queued are displayed in the remote print server entry for the queue.

The **rembak** program also sends requests to cancel print jobs to the remote print servers. Each print job is assigned a number. As shown in the preceding example, print queue status requests display the job numbers for currently queued or running print requests. To cancel a job on a remote queue, use the same commands used to cancel local print jobs. For example, to cancel job **298** from the queue **rq**, you can use one of the following commands:

```
qcan -Prq -x298
```

OR

```
lpim -Prq 298
```

## lpd daemon

Although local and remote print jobs are submitted with the same commands, they are processed differently. After a print job has been transmitted to a remote host, it is no longer managed by the local print spooling subsystem.

The **lpd** daemon is part of the TCP/IP system group. Any host on a TCP/IP network can run the **lpd** daemon, and any host can send print requests to any other host on the network (if the host is currently running **lpd**). As a security measure, the **lpd** daemon forks a child process that checks each remote print request against two database files: the `/etc/hosts.equiv` file and the `/etc/hosts.lpd` file. If the name of the host submitting the print request is not in the `/etc/hosts.lpd` file, the print request is rejected.

**Note:** The `/etc/hosts.equiv` file defines which computers on a network are allowed to execute certain commands on a local host without supplying a password. The `/etc/hosts.lpd` file defines which computers on a network are allowed to execute print commands on a local host without supplying a password.

The **lpd** daemon on the remote print server monitors port 515 for print requests. When the **lpd** daemon receives a print request from a valid host, it places the request in the specified queue. The **lpd** daemon places files specified in print requests in the directory `/var/spool/lpd`. The print request is then managed by the **qdaemon** and the appropriate backend (usually **piobe**) on the remote server.

The `/etc/locks/lpd` file contains the process ID of the currently running instance of the **lpd** daemon. If a machine running the **lpd** daemon becomes inoperable, the ID for the **lpd** daemon might have to be removed before the system is restarted. The error messages **lpd: lock file** or **duplicate daemon** indicate that the ID must be removed.

### lpd daemon control

Controlling the **lpd** daemon includes starting and stopping the **lpd** subsystem and changing the characteristics of the **lpd** subsystem.

There are three ways to start the **lpd** daemon. If it is not currently running, you can start the daemon at any time. You also have the option of having the **lpd** daemon start at system restart or to have it start both at the current time and at system restart. The same options are available to stop the **lpd** daemon: stop now, stop at system restart, or stop both now and at system restart. You can run the **lpd** daemon with **DEBUG**, with **SYSLOG**, with both **DEBUG** and **SYSLOG**, or with neither.

To control the **lpd** daemon with SMIT, type `smit lpd`, and then select the desired options from the SMIT menus. To control the **lpd** daemon with the SRC, use the following SRC commands:

Item	Descriptor
<b>startsrc</b>	Starts a subsystem, group of subsystems, or a subserver.
<b>stopsrc</b>	Stops a subsystem, group of subsystems, or a subserver.
<b>lssrc</b>	Gets the status of a subsystem, group of subsystems, or a subserver.
<b>refresh</b>	Causes the subsystem or group of subsystems to reread the appropriate configuration file.

Item	Descriptor
<b><u>traceson</u></b>	Enables tracing of a subsystem, group of subsystems, or a subserver.
<b><u>tracesoff</u></b>	Disables tracing of a subsystem, group of subsystems, or a subserver.

## Managing and using remote printers and queues

To print to a remote system, you must set up a remote queue on the local system.

Setting up a remote queue involves tasks, such as naming a queue and a queue device on the local host, and indicating the name of the remote host and the queue on the remote host to which print jobs are sent.

### Setting up a remote print queue

You can set up a remote print queue with SMIT.

The queue on the remote host designated to receive remote print requests must be an active queue.

- To set up a remote queue use the **smit mkrque** command.
- For more information, see [“Adding a print queue device” on page 18.](#)

### Remote printing and the qconfig file

The **qconfig** file contains stanzas that define queue devices. For a remote printer, some of the field values in the device stanza differ from those for a local printer.

The following table lists the fields which have particular significance for remote printers. The table also shows sample values or default values for these fields.

Remote queue devices	Sample or default values	Description
host	sys2	Name of the remote host (print server) where jobs will be printed.
rq	q2	Name of the remote queue on which jobs will be printed.
s_statfilter	/usr/lpd/aixshort	Filter used to translate remote queue status information into a short form for queue status requests, such as <b>qchk</b> . This is the default value when the remote print server is another base operating system.
	/usr/lpd/bsdshort	Filter used to translate BSD <b>lpq</b> command output (short form) when the remote print server is a BSD system.
	/usr/lpd/attshort	Filter used to translate ATT <b>lpstat</b> command output (short form) when the remote print server is an ATT system.
l_statfilter	/usr/lpd/aixlong	Filter used to translate remote queue status information into a long form for queue status requests such as <b>qchk</b> . This is the default value when the remote print server is another base operating system.
	/usr/lpd/bsdlong	Filter used to translate BSD <b>lpq</b> command output (long form) when the remote print server is a BSD system.
	/usr/lpd/attlong	Filter used to translate ATT <b>lpstat</b> command output (long form) when the remote print server is an ATT system.

## Configuring a remote host as a print server

You can configure a remote host as a printer server.

When you use a remote host as a print server, you must configure the host to accept remote print requests. A host must be listed in the `/etc/hosts.lpd` file on the print server to have permission to print.

1. At the system prompt, type **smit mkhosts1pd** and then follow the instructions to complete the task.
2. To add the host name to the `/etc/hosts.lpd` file, open and edit the Host Access list.

A print request sent from a host that is not defined in the print server's `/etc/hosts.lpd` file is rejected. The system displays an error message indicating that the host does not have line printer access.

A host acting as a print server must also have its **lpd** process running to service print requests. The SRC **lssrc -s lpd** command shows the status of the **lpd** daemon. If the daemon is not active, use the **startsrc** command to start the **lpd** daemon.

## Remote printers and queues

No special commands are required to print to a remote host. Use any print command that allows you to specify a queue.

The **lpr**, **qprt**, and **enq** commands are examples of print commands. Use the appropriate flags and options to tailor the print request, including the flag that specifies the queue. Use the name of the remote queue on your host.

You can also send a remote print request with the **smit qprt** fast path.

Queue status commands, such as **qchk** or **lpstat**, display information for both local and remote print queues. The **smit qchk** command displays a menu that allows you to choose the type of queue status information you want from both local and remote queues.

To cancel a print job in a remote queue, use the **qcan** command, or the **lprm** command. You can also use the **smit qcan** fast path.

## Listing all remote hosts

You can list remote hosts with the **ruser** command, or SMIT.

The following conditions must be met to list remote hosts:

- Your system must be configured to communicate as a remote print server.
- The **lpd** daemon must be installed on your system.
- To list remote hosts, you must understand [naming conventions](#) for TCP/IP.

**Note:** The information in this how-to scenario was tested using specific versions of AIX. The results you obtain might vary significantly depending on your version and level of AIX.

At the system prompt, type **smit lshosts1pd** and then follow the instructions to complete the task.

You can also use the **ruser -sP** command.

## Adding a remote host

You can add a remote host with the **ruser** command, or SMIT.

- Your system must be configured to communicate as a remote print server.
- The **lpd** daemon must be installed on your system.
- To add a remote host, you must understand [naming conventions](#) for TCP/IP.

**Note:** The information in this how-to scenario was tested using specific versions of AIX. The results you obtain might vary significantly depending on your version and level of AIX.

## Deleting a remote host

You can delete a remote host.

- Your system must be configured to communicate as a remote print server.
- The **lpd** daemon must be installed on your system.
- To delete a remote host, you must understand [naming conventions](#) for TCP/IP.

**Note:** The information in this how-to scenario was tested using specific versions of AIX. The results you obtain might vary significantly depending on your version and level of AIX.

To delete a remote host:

At the system prompt, type **smit rmhosts1pd**, or the following **ruser** command

You can also perform this task with the SMIT fast path **smit rmhosts1pd** or command:

```
ruser -d -p HostName
```

## Starting the lpd remote subsystem

You can start the **lpd** remote subsystem with the **startsrc** or **mkitab** command, or SMIT.

- Your system must be configured to communicate with a remote print server.
- To start the **lpd** remote subsystem, you must have root authority.

**Note:** The information in this how-to scenario was tested using specific versions of AIX. The results you obtain might vary significantly depending on your version and level of AIX.

At the system prompt, type **smit mkitab\_1pd** and then follow the instructions to complete the task.

You can also perform this task with the following commands:

- To start the **lpd** remote subsystem now:

```
startsrc -s lpd
```

- To start the **lpd** remote subsystem at the next system restart:

```
mkitab "lpd:2:once:startsrc -s lpd"
```

- To start the **lpd** remote subsystem both now and at the next system restart:

```
startsrc -s lpd; mkitab "lpd:2:once:startsrc -s lpd"
```

## Stopping the lpd remote subsystem

You can stop the **lpd** remote subsystem with the **stopsrc** or **rmitab** command, or SMIT.

- Your system must be configured to communicate with a remote print server.
- To stop the **lpd** remote subsystem, you must have root authority.

**Note:** The information in this how-to scenario was tested using specific versions of AIX. The results you obtain might vary significantly depending on your version and level of AIX.

At the system prompt, type **smit rmitab\_1pd** and then follow the instructions to complete the task..

You can also perform this task with the following commands:

- To stop the **lpd** remote subsystem now:

```
stopsrc -c -s lpd
```

- To stop the **lpd** remote subsystem at the next system restart:

```
rmitab "lpd"
```

- To stop the **lpd** remote subsystem both now and at the next system restart:

```
stopsrc -c -s lpd; rmitab "lpd"
```

## Printing bidirectional data

---

The printing of bidirectional (bidi) data requires special handling due to the nature of the text. In most cases where data is stored in the order it is entered such as logical ordering scheme), the text must undergo a process of layout transformation. This process involves reordering so the characters that they are displayed in a readable sequence to the user. In cases where the data contains Arabic scripts, the process will include an additional step, *shaping*, in which the characters are converted into the correct glyphs according to their position within the text.

Bidi data can be printed in two main forms: either as an image or as text. Data in image format will generally not require any modification as it is stored in the exact way it should be printed. Where it is stored as text, the layout transformation process might need to be performed before it is sent to the printer, depending on whether there is a need for layout transformation or not based on the ordering scheme in which the data is stored. If the data is stored in a visual ordering scheme and shaped, this implies that layout transformation is required. If the data is stored in a logical ordering scheme, this implies that reordering and shaping is required. When required, the bidi print filter serves the main role of performing this layout transformation on the text before it is sent to the printer.

### Bidirectional Print Filters

The bidi print filters bundled with AIX only support text-based data. They are designed to be run as a part of the AIX printing subsystem as preprocessing filters.

There are three separate filters:

Item	Descriptor
/usr/bin/brpt	Bidi print filter for ASCII data streams.
/usr/bin/pcl_brpt	Bidi print filter for PCL data streams.
/usr/bin/ebprt	Bidi print filter with support for data in a tabular layout.

The filters **/usr/bin/brpt** and **/usr/bin/pcl\_brpt** are preserved to maintain existing support for customers. It is recommended that you use the **/usr/bin/ebprt** filter, as it provides tabular data support enhancements.

### Printing Bidirectional Data using the /usr/bin/ebprt filter

The **/usr/bin/ebprt** print filter supports two modes that affect the method of processing:

#### Normal mode

Data is processed as a single line of text at a time.

#### Tabular mode

Data is formatted in a tabular layout. The requirement for this mode of operations arises when the data to be printed is in tabular format that cannot be processed as a single line. Attempts to process the data as a single line of text will result in the fields being incorrectly aligned and damaging the intended tabular structure. This requires the filter to understand the layout of the data being processed in order to preserve the location of the fields within a table.

### Tabular Data Support and What to Expect

In order for **/usr/bin/ebprt** to understand the format of a report, separators that indicate the start and end of a field within a table must be embedded in the text before it is received by the filter. The insertion

of the separators must be done during the file generation phase by the user. This allows the filter to process the data without corrupting the field order. The filter provides an option to hide these separators from the final output on the printer in order to satisfy user requirements. Information describing the separator used must be specified by the user in the configuration file `/etc/ebprt.conf`. With separators embedded in the required positions to delimit data fields, the filter will guarantee that the pre-formatted layout will not be lost. In the case where it is difficult or not feasible to insert separators during the report generation phase, the filter may be configured to use the white space character as a field separator. This option must be used with care as it does not guarantee that the output will match the desired format.

## Locale and Codepage Support

The filter is designed to only support Bidi locales. This includes Arabic and Hebrew locales with their corresponding code pages. For more information about AIX locales, see [Supported languages and locales](#). Refer to [“Known limitations of escape sequence and PCL support”](#) on page 44 for issues regarding locale support.

## Installation and Packaging

The bidi print filters are installed as a part of the `bos.loc.bidi` fileset.

## Configuring the Print Subsystem to use the Bidirectional Print Filter

The bidi print filter is integrated into the AIX printing process. This means that after configuration is complete, you can print bidi data using the normal print commands such as `lp`, `qprt`, or `enq`. You can control the bidi filter behavior by setting environment variables before running the print commands.

To configure the `/usr/bin/ebprt` print filter as a part of the AIX print subsystem, complete the following steps:

1. Create a print queue.
2. Add the `/usr/bin/ebprt` printer filter to the Printer Queue Attributes in SMIT by completing the following steps:

From the SMIT main menu, click **Print Spooling > AIX Print Spooling > Change / Show Print Queue Characteristics**. Select the Queue created in the previous step. click **Default Print Job Attributes**, and set the following:

- a. Pre-processing FILTER NAME to "p"
- b. the CODE PAGE of the print file
- c. the CODE PAGE of the printer

From the SMIT main menu, click **Print Spooling > AIX Print Spooling > Programming Tools**. Select the **Change / Show Pre-processing Filters**. Set the `pr` filter to `usr/bin/ebprt -w%IwW`.

**Note:** If the data being printed is Arabic, the print file code page value must always be set to "IBM-1046", even if the data is in "ISO8859-6" encoding. This is to ensure that the output sent to the printer can contain shaped glyphs.

3. Set the appropriate environment variables
  - LANG: the installed bidi locale for the filter to run under.
  - EBPRTCFG: the profile name loaded from the configuration file.
4. Run a print command.

This can be done by running the `lp`, `qprt`, or `enq` commands on the file name with the queue name defined.

## Configuring the `/etc/ebprt.conf` configuration file

The `/etc/ebprt.conf` configuration file is structured in stanzas. Each stanza represents a profile that is loaded by name during runtime. The profile name is set in the EBPRTCFG environment variable that

should be loaded before the filter runs. By default, the EBPRTCFG environment variable is assumed as a profile named **default**, which is read from the **/etc/ebprt.conf** configuration file. You can modify this profile to alter default behavior that will also be used in case the EBPRTCFG environment variable is not set before the filter runs. This is only applied for the **default** profile. Any other profiles that are user-defined must be loaded explicitly.

## Security and Permissions

The configuration file is by default owned by the **root** user and the **printq** group. The permissions set for the file allow only those in the **group printq** and the **root** user to write to the file, but everyone will have read access.

## Configuration Options

The following table lists the configuration file parameters with their corresponding accepted values.

The attributes below must be set in the following syntax:

*AttributeName = Value*

Attribute Name	Possible Values	Description
PageDirection	RightToLeft (Default)	This value defines the direction of the text within the page.
	LeftToRight	This value defines the direction of the text within the page.
NumeralShaping	National	Specifies that the numerals will appear as National (Arabic-Indic). This attribute only applies to Arabic locales.
	Nominal	Specifies that the numerals will appear as National (Arabic-Western). This attribute only applies to Arabic locales.
	Contextual (Default)	Specifies that the numerals appear based on their position within the context. This attribute only applies to Arabic locales.
SymmetricSwapping	Yes (Default)	Specifies that symmetric swapping is enabled.
	No	Specifies that symmetric swapping is disabled.
ArabicSpecialShaping	Yes	Specifies that Arabic twocell shapes should be activated. This indicates that the LamAlef and Seen family characters will be printed as two characters instead of one. This overrides normal shaping behavior.
	No (Default)	Specifies that Arabic twocell shapes are disabled. Normal shaping will take effect.
FilterMode	Normal (Default)	Specifies the text in the file is treated as unstructured. If this option is specified, any separator-related attributes are ignored.
	Tabular	Specifies that the text in the file is treated as a tabular layout.

Attribute Name	Possible Values	Description
Separator	A printable character or list of characters. Default is the vertical bar ( ).	Specifies the separator to delimit fields in a table. This can be up to a maximum of two different separators in a single line of tabular text. However, the length of the separators must be consistent. The characters must be printable characters. Example: Separator = +  indicates that the file includes both the plus sign (+) and the vertical bar ( ) separators. The length of the separator is specified by the SeparatorLength attribute.
	The keyword SPACE	Specifies that white spaces are used to delimit the fields in a table. The number of white spaces is specified by the SeparatorLength attribute.
SeparatorLength	A positive number. Default is 1.	Specifies the length of the separator. This must be consistent throughout a single file. The value must be positive and has a maximum of two digits.
HideSeparator	Yes (Default)	Specifies that the separator will not be displayed. The separator will be replaced with white spaces.
	No	Specifies that the separator will be displayed.
FieldDirection	RightToLeft	This value defines the direction of the text within a field.
	LeftToRight	This value defines the direction of the text within a field.
	Contextual (Default)	This value defines the direction of the text within a field. The direction and alignment will depend on the first letter in the text. If the first letter is a <b>bidirectional</b> character, then the value is RightToLeft. If the first letter is Latin, then it is LeftToRight.
TableColumnOrderReverse	Yes (Default)	Specifies that the column order in a tabular layout <b>will be</b> reversed. If not specified, this value is inherited from PageDirection. If PageDirection = RightToLeft, the value is Yes. If PageDirection = LeftToRight, the value is No.
	No	Specifies that the column order in a tabular layout <b>will not be</b> reversed. If not specified, this value is inherited from PageDirection. If PageDirection = RightToLeft, the value is Yes. If PageDirection = LeftToRight, the value is No.
HeaderSize	A positive number	Specifies the number of lines that should be treated as a header. These lines are not considered part of the table even if the loaded profile indicates a tabular mode. The allowed value is a positive number with a maximum of three digits. The default value, 0, <b>will</b> disable this feature.
	0 (Default)	

Attribute Name	Possible Values	Description
CoverPages	A positive number	Specifies the number of pages that should be treated as cover pages. These lines are not considered part of a table even if the loaded profile indicates a tabular mode. The allowed value is a positive number with a maximum of digits. The default value, 0, <b>will</b> disable this feature.
	0 (Default)	
Logging	Yes	Messages <b>will be</b> logged to help debug problems.
	No (Default)	No messages <b>will be</b> logged.
in_orientation (advanced)	RTL	Specifies the input orientation value to be passed to the <b>bidirectional layout engine</b> .
	LTR	
	Contextual	
out_orientation (advanced)	RTL	Specifies the output orientation value to be passed to the <b>bidirectional layout engine</b> .
	LTR	
	Contextual	
in_typeoftext (advanced)	Implicit	Specifies the input typeoftext value to be passed to the <b>bidirectional layout engine</b> .
	Visual	
out_typeoftext (advanced)	Implicit	Specifies the output typeoftext value to be passed to the <b>bidirectional layout engine</b> .
	Visual	
in_swapping (advanced)	Yes	Specifies the input swapping value to be passed to the <b>bidirectional layout engine</b> .
	No	
out_swapping (advanced)	Yes	Specifies the output swapping value to be passed to the <b>bidirectional layout engine</b> .
	No	
in_numeralshaping (advanced)	Nominal	Specifies the input numeral shaping value to be passed to the <b>bidirectional layout engine</b> .
	National	
	Contextual	
out_numeralshaping (advanced)	Nominal	Specifies the output numeral shaping value to be passed to the <b>bidirectional layout engine</b> .
	National	
	Contextual	
in_textshaping (advanced)	Nominal	Specifies the input text shaping value to be passed to the <b>bidirectional layout engine</b> .
	Shaped	
out_textshaping (advanced)	Nominal	Specifies the output text shaping value to be passed to the <b>bidirectional layout engine</b> .
out_textshaping (advanced)	Shaped	

**Notes:**

- Attributes that are marked as "advanced" are reserved to specify values that are sent directly to the Layout Engine according to the specification it follows. Take special care when using these attributes.

They should be set in pairs (input and output), but if only one attribute is set, the value for the matching attribute is inherited from other general attributes that are defined. For instance, if the `in_swapping` attribute is set to "yes" and the `out_swapping` is not, then the `SymmetricSwapping` attribute will be used to identify the missing value.

2. The attributes keywords and their corresponding values are not case-sensitive. However, using upper case for first letter of the word will improve the readability of the configuration file.

## Sample Configuration file for `/etc/ebprt.conf`

Following is the sample configuration file for `/etc/ebprt.conf`:

```
#
# These values reflect the default /usr/bin/ebprt behavior.
#
[Default]
PageDirection = RightToLeft
NumeralShaping = Contextual
SymmetricSwapping = Yes
ArabicSpecialShaping = No
FilterMode = Normal
Separator = |
SeparatorLength = 1
HideSeparator = Yes
FieldDirection = Contextual
TableColumnOrderReverse = Yes
HeaderSize = 0
CoverPages = 0
Logging = No
```

## Configuration Examples

The following example illustrates values that are set during print queue configuration in order to print a file that contain IBM-1046 data along with a configuration profile named **MyReport**.

### Sample Configuration Profile

The following sample configuration profile is used to print a tabular report with right-to-left direction that has English and Arabic text, and that uses three white spaces to separate the fields. The fields themselves have a right-to-left direction and numerals are in Arabic-Indic format:

```
[myreport]
PageDirection = RightToLeft
FieldDirection = RightToLeft
FilterMode = Tabular
Separator = SPACE
SeparatorLength = 3
NumeralShaping = National
```

## Print Queue Configuration

To create a printer queue configuration:

1. Create a print queue named **ibmeg**.
2. Add the `/usr/bin/ebprt` print filter to the queue **ibmeg** using SMIT:
  - Set the pre-processing **FILTER NAME** to **p**.
  - Set the **CODE PAGE** of print file **IBM-1046**.
  - Set the **CODE PAGE** of printer to **ibm.1046**.

- Set the **pr** filter to **/usr/bin/ebprt -w%IwW**
3. Set the environment variables:

```
$ export LANG=Ar_AA
$ export EBPRT=myreport
```
  4. Print the file called **report1**:

```
$ lp -d ibmeg report1
```

## Troubleshooting

The *Logging* attribute specified in the **/etc/ebprt.conf** file allows messages to be logged using the **syslogd** daemon. The messages are logged using the syslogd facility **LOG\_LPR** with priority **LOG\_DEBUG**.

For example:

Assuming a file named **/tmp/ebprt.log** is created and the syslogd daemon is running, the following entry under the **/etc/syslogd.conf** file will catch the debugging messages:

```
lpr.debug
```

## Known limitations of escape sequence and PCL support

The data read by the **/usr/bin/ebprt** print filter is expected to be in plain text, which is free of any escape sequences. No support is provided for escape sequences.

### UTF-8 Support

The bidi print filter, **/usr/bin/ebprt**, currently provides no support for UTF-8 data.

## Print spooler

---

The job of the spooler, also called the *queuing system*, is to manage printer use, especially on systems that have more than one printer.

### Spooler backend

Because the backend **pio**, used to process print jobs on local queues, is the most commonly used and possibly the most complex backend shipped with the base operating system, it is used as the primary example in this section. Using **pio** in this fashion will allow a better development of the base operating system spooler concepts.

The purpose of this section is to demonstrate that the spooler is a real process with a beginning, discrete points in between (no black boxes), and an end. The spooler is a series of components whose interaction is completely dependent upon how a specific queue is configured. Recognizing this can have the following results:

- Problem determination and resolution can become easier.
- Bending the spooler to your specific business needs can become easier.
- You may see opportunities for spooler modification that you had not considered.

## Formatter filters

A *formatter filter* is part of the pipeline created and executed by the default backend for local printer queues, **pio**.

A formatter filter provides the capability of either formatting an input file or passing it through unmodified, based on an input parameter. Even if the formatter passes the input file unmodified, it still sends printer commands to initialize the printer before the input file is printed and restores the printer to its original state after printing is complete.

It is the formatter filter that has the capability of using a virtual printer's colon file to perform extensive manipulation of a spooler print job.

## Local and remote printers

A *local printer* is a real printer attached to a local host, for which there is a local queue.

All jobs submitted to this queue are processed and printed on the host on which the queue exists. A *remote printer* is a real printer attached to a remote host. The queue for a remote printer specifies a backend whose function is to send the spooled job from the local host across the network to the remote host. All jobs submitted to this queue, on the local host, are sent across the network to the remote host where they are processed and printed.

## Printer devices

A *printer/plotter device* is a special file in the `/dev/directory` for a real printer.

This file can be used by redirection (for example, `cat FileName > /dev/lp0`) or by user-written, compiled programs. Settings for this device driver can be displayed and changed using the **sp1p** command. Before any of the spooler commands can access a printer device, a print queue must be created for the device.

## qdaemon process

The **qdaemon** tracks both job requests and the resources necessary to complete the jobs, where the resources may be a real printer, some other real device, or even a file.

The **qdaemon** is a process that runs in the background under the auspices of the **srcmstr** process. When you turn your system on, the **startsrc** command starts the **qdaemon**. While the **qdaemon** can be started by the **startsrc** command or stopped by the **stopsrc** command, the **qdaemon** supports only signal communications and thus cannot be queried by the **lssrc** command.

The **qdaemon** tracks both job requests and the resources necessary to complete the jobs, where the resources may be a real printer, some other real device, or even a file. The **qdaemon** maintains queues of outstanding requests and sends them to the proper device at the proper time. The **qdaemon** also records printer usage data for system accounting purposes. It is the **qdaemon** that sets the backend for a spooler queue into execution.

If the **qdaemon** is aborted, it will be restarted by **srcmstr**.

**Note:** Do not attempt to stop the **srcmstr** daemon; it controls other daemons running on your system.

## Real (physical) and virtual printers

A *real (physical) printer* is the printer hardware attached to the system via a serial or parallel port, or through a network connection such as a network terminal server.

When the real printer is attached via a serial or parallel port local to the system, the printer device driver in the kernel communicates with the printer hardware and provides an interface between the printer hardware and a virtual printer.

A *virtual printer* is a set of attributes and their associated values that define a high-level data stream (such as ASCII or Postscript) and the methods for processing that data stream. This does not include information about how the real printer is attached to the host computer or about the protocol used for transferring bytes of data to and from the real printer. The **pio** backend uses information stored in the virtual printer definition to control print job processing. The physical storage medium of the sets of attributes and their associated values is called a *printer colon file*.

## Spooler functions and services

The base operating system *spooler* is a collection of programs, configuration files, and data files.

The base operating system spooler provides the following functions or services:

- Provides for the construction of queues, which are software entities whose function is to process jobs in specific ways
- Allows users to submit jobs (usually but not always printer jobs) to a queue for processing.
- Provides serial access through a queue to a device (such as a real printer), or to a program (such as a compiler), avoiding simultaneous use of a single device or program by multiple users
- Allows users to query the status of queues through status files
- Allows users to control the availability of queues and the status of jobs
- Performs extensive manipulation of print job data stream
- Offers a wide-range of delivery mechanisms for the processed job

## Spooler backends

A *spooler backend* is a collection of programs (a pipeline) started by the spooler's **qdaemon** command to manage a spooler job that is queued for processing.

When the backend is for a print queue, the spooler backend typically performs the following functions:

- Receives from the **qdaemon** command a list of one or more jobs to be processed.
- For print jobs, uses printer and formatting attributes from the database, overridden by any flags specified on the command line.
- Initializes the printer before processing a print job.
- Provides filters for simple formatting of ASCII documents.
- Uses filters to convert print job data stream to a format supported by the printer.
- Provides support for printing national language characters.
- Passes the filtered data stream of a print job to the printer device driver.
- Generates header and trailer pages for print jobs, if requested.
- Generates multiple copies of print jobs, if requested.
- Reports paper-out, intervention-required, and printer-error conditions.
- Reports problems detected by the filters.
- Cleans up after a job is cancelled.
- For print jobs, provides an environment that you can customize to address specific printing needs.

You typically do not run printer backend programs directly, although backends such as compilers can clearly be run directly from the command line. The **qdaemon** runs the backend, sending it the names of files and any job control flags that you specify. The backend communicates with the **qdaemon** through a status file in the `/var/spool/lpd/stat` directory. You can use a queue status query command such as **qchk** or **lpstat** to display status information, including, in the case of a print job, the printer status, the number of pages printed, and the percentage of the job that is finished.

In the base operating system, **pio** is the standard spooler backend for processing local print jobs.

## Spooler jobs

A *spooler job* is any job that a user submits to the spooler.

All job submission commands must end with the names of one or more files that require processing. You cannot, for example, pass a keyword to a backend and have the keyword control the function that backend will perform; the submitted job must exist in the file system.

The spooler will accept many types of jobs. It is the responsibility of the system administrator to ensure that the backend for a given queue is capable of processing any job submitted to that queue.

Printer job types include:

- ASCII
- Postscript

- PCL
- HPGL
- GL
- Diablo 630
- ditroff

## Generic base operating system spooler

---

The base operating system spooler is not specifically a print job spooler but a generic spooling system that can be used for queuing various types of jobs, including print jobs queued to a printer queue.

The spooler does not know what type of job it is queuing. When a queue is created, the function of the queue is defined by the spooler backend for that queue. For example, if a queue is created and the queue backend is set up to be **piobe** (the default printer I/O backend for local printer queues), the queue is a print queue. Likewise, if the queue backend is set up to be **cc** (or any other compiler), the queue is for compiler jobs. When the spooler's **qdaemon** component selects a job from a queue, it processes the job by invoking the queue's backend.

This section views the spooler as a generic spooling system with an entry point, an exit point, and points in-between. Jobs submitted to the spooler enter the system (job submission), travel along a predictable path from point to point (job processing), and then exit the system (job delivery and cleanup). Understanding the flow of the job through the system is crucial to both configuring queues to execute complicated tasks and to effective problem determination and resolution. The following sections describe this job flow in greater detail, making special note when the queue is a print queue.

## Spooler parts

---

The base operating system spooler can be viewed as a process or a subsystem with a beginning, points-in-between, and an ending.

To accomplish its tasks, the base operating system spooler has four basic parts:

1. The **enq** command is the true entry point to the spooler, and as such is the beginning of any spooler activity. This command accepts requests for job processing.
2. The **qdaemon** is responsible for accepting and tracking all jobs submitted to the spooler by the **enq** command. It is also responsible, after all the necessary resources are available, for allowing a queue backend to process a job. The **qdaemon** is one of the points-in-between in the spooler process.
3. The spooler backend is a collection of programs invoked by the spooler's **qdaemon** command to process a job in some queue. The backend sends output to a specific device, such as a printer. When the backend is **piobe**, it involves a formatter filter, which in turn involves a printer colon file. The backend is one of the points-in-between as well as the ending because the backend contains the specific process that will deliver the processed job to its final destination.
4. The configuration file, `/etc/qconfig`, describes the configuration of available queues and devices. Both the **enq** command and the **qdaemon** command, see the configuration file. This configuration file is considered as conceptually important as the other three spooler parts due to its critical value to the correct operation of the base operating system spooler as a whole.

## Spooler data flow: commands and backend

---

Four commands can be used to submit a job to the base operating system spooler. These are **lp**, **lpr**, **qprt**, and **enq**.

Each of these commands has a specific UNIX origin: **lp** originated with AT&T System V, **lpr** originated with BSD, and both **qprt** and **enq** originated with the base operating system.

While a user can use any one of these four commands to submit a job to the spooler, the true entry point to the spooler is the **enq** command. All of **lp**, **lpr**, and **qprt** are front ends to **enq**. **lp**, **lpr**, and **qprt** all

parse their arguments and compose a call to **enq**. The front ends differ from one another in the way each one behaves and in the number and types of flags each one accepts.

When a job is submitted to the spooler, **enq** processes the job request. If the job request is valid, which basically means that the command syntax was correct, the job is placed upon a queue. **enq** creates a job description file (JDF) and notifies the **qdaemon** of the existence of the new JDF.

The **qdaemon** reads each new JDF and reads the job parameters specified by the JDF into an internal data structure that it maintains to track job requests. The **qdaemon** uses queue status information to keep track of the status of each queue and, when circumstances are right, will invoke the backend for the queue to process the job.

The backend for a queue determines precisely how a job placed on that queue will be processed. The commands that allow users to submit jobs to the spooler can specify flags requesting certain treatment of the job, the **qdaemon** can determine which job gets processed when (shortest-job-next or first-come-first-served), but the backend is the process that actually does all the work as far as processing the job is concerned. (A systems administrator can read the stanzas in `/etc/qconfig` and quickly determine the function of a given queue simply by examining the backend.)

In the following figure, the two most common backends scenarios are shown: a local printer queue and a remote printer queue. The local queue uses **piobe** (Printer Input/Output BackEnd) as a backend. The remote printer queue uses **rembak** (REMote BAcKend) as a backend.

**piobe**, like all backends, is invoked by the **qdaemon**. **piobe** sets up and controls a series of programs (a pipeline) that can not only perform extensive manipulation of a print job but can also send an extensive amount of control data to a printer, for example, to initialize the printer to a specific mode before the processed job is delivered to the printer. It is **piobe** that makes the initial use of the data stored in printer colon files. The last program in the pipeline set up and controlled by **piobe** is responsible for the physical delivery of the byte stream generated earlier in the pipeline. In the context of a local queue, this program opens a device driver which will deliver the byte stream to a locally attached printer (attached serial or parallel), or to a network-attached printer.

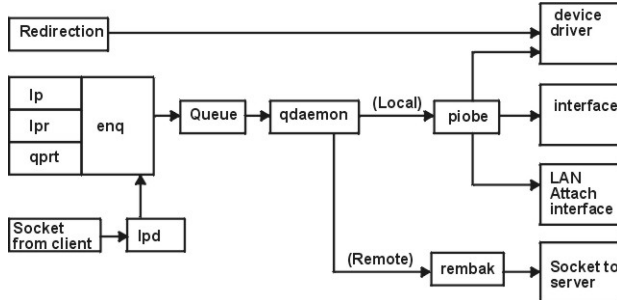

Figure 1. Printing with the Base Operating System

**rembak** is a common backend when the remote printer queue simply points to a queue on another host, better known as a print server. While **piobe** can perform extensive manipulation of a print job, **rembak** just transfers jobs across TCP/IP networks to print servers. As the Printing with the Base Operating System figure depicts, if the print server is another base operating system-based machine, **rembak** transfers the job across the network to the **lpd** process, which in turn invokes **enq**, which creates a JDF, and so on as described above.

## Spooler data flow (enq command)

The commands **lp**, **lpr**, **qprt**, and **enq** can be used to submit a job to the spooler for processing.

The **enq** command is the true entry point to the spooler; **lp**, **lpr**, and **qprt** all parse their own arguments and compose a call to **enq**. This can be demonstrated by executing the following steps as the root user at a shell prompt:

1. Enter `mount /bin/echo /bin/enq`.
2. Enter `qprt -Pasc -fp -z1 -p12 -s courier -C -N 3 /etc/motd`.

3. Enter `umount /bin/enq`.

The **qprt** command in step 2 attempts to submit a print job to the spooler and have it placed on the queue named **asc**, requesting three copies of the message-of-the-day in a 12-point Courier font rotated 90 degrees. **qprt** parses its command line arguments and builds an argument vector to pass to **enq**. When the **qprt** command tries to invoke **enq** with the argument vector, it instead invokes the **echo** command, which is mounted over the **enq** command. Thus the argument vector generated by the **qprt** command is passed to the **echo** command, which in turn simply echoes the argument vector to your display. This procedure will work with **lp** and **lpr** as well. Aside from demonstrating that **qprt** really is a front end to **enq**, this technique is also useful when you are trying to figure out how to get unsupported flags into the spooler. See “Filters” on page 131 for further information.

Execution of the **qprt** command in step 2 should cause the following output to be written to the display element specified by your **TERM** environment variable:

```
-P asc -o -o -f -o p -z -o 1 -o -p -o 12 -o -s courier -C -N 3 /etc/motd
```

This is the argument vector generated by this specific instance of the **qprt** command. If **echo** had not been mounted over **enq**, the following job submission command would have been executed:

```
enq -P asc -o -f -o p -o -z -o 1 -o -p -o 12 -o -s courier -C -N 3 /etc/motd
```

A job submission command must end with the name of one or more real files that exist in a file system accessible by the base operating system. This is true even when the queue is set up to handle jobs other than print jobs.

**Note:** Make sure that you execute step 3. Otherwise, the spooler will be disabled.

When the **enq** command is executed, either directly or by **lp**, **lpr**, or **qprt**, it assigns a job number to the job. By default, **lp** will return the job number. **lpr** and **qprt** will not return the job number unless you specifically request it with a flag.

**enq** creates a JDF and places it in `/var/spool/lpd/qdir`, then writes the name of the JDF to a message queue and signals the **qdaemon** (by sending it a SIGUSR2) that a new JDF exists. The **qdaemon** then reads the name of the JDF from the message queue, accesses the JDF directly, and reads the data contained in the JDF into an internal data structure it maintains to track all the jobs currently in the spooler. At this point in time, the job has been accepted by the spooler.

A JDF is created for all spooling system operations other than a queue status query; the structure of a JDF differs between print requests versus job cancellation requests versus queue control requests, and so on, but a JDF is created nevertheless. Commands with the same function as **lpstat** still call **enq** to do their work, but neither is a JDF created nor is the **qdaemon** involved.

When the **qdaemon** determines that the device upon which the job is queued is available, the **qdaemon** invokes the backend for the queue, passing it arguments specified by the JDF. The backend processes the job.

## Backend processing

The backend for a queue is begun by **qdaemon**; the **qdaemon** determines that a job's turn to be processed has arrived, sets up an execution environment for the queue backend, constructs an argument vector for the backend, and, via **fork** and **exec**, causes the backend to begin execution.

The number of simultaneous instances of the backend is controlled by the presence or absence of the *file* parameter in the stanza for this queue in the `/etc/qconfig` configuration file. If the *file* parameter is present, then only one instance of the backend can exist *for this queue*; This is because the **qdaemon** will only attempt to set the execution environment for the backend when it has determined that the job can be processed. Part of setting the backend's execution environment involves opening stdout of the backend onto the file or device specified by the *file* parameter. If the **qdaemon** has already performed this action for a previous job, and that job is still executing, then the **qdaemon** cannot get a lock on the file or device specified by the *file* parameter and hence cannot open stdout of the backend onto that file or device. Thus

the **qdaemon** holds the job in the queue and waits for the previous job to complete execution and release the file or device. This is how the spooling system provides and controls serial access to a device.

If the *file* parameter is absent or set to a value of FALSE, the **qdaemon** opens stdout of the backend onto /dev/null and executes the job immediately. In this situation there is no clear file or device to which serial access should be provided, so jobs will not stack up on the queue. Jobs submitted to this queue will be processed just as fast as the **qdaemon** can set up the execution environment. The absence of the *file* parameter effectively disables serial access to any local file or device.

A meaningful and common example of a queue lacking the *file* parameter is a remote printer queue. In this situation, the resource to which serial access should be provided actually exists on another host; there is no reason for the local queue to attempt any type of control. The backend for this type of queue, by default the **rembak** program under the base operating system, simply sends the job across the network to the remote queue and lets it handle the serial access control.

The default backend for a local print queue under the base operating system is **piobe**. Multiple queues can all specify the same backend. In this situation, multiple simultaneous instances of **piobe** can exist; each queue that specifies **piobe** as its backend can potentially generate an instance of **piobe**. However if two or more queues also specify the same value for the *file* parameter, the serial access restriction is applied. The **qdaemon** will not be able to acquire a lock on the specified file or device if the **qdaemon** has already acquired the lock for another instance of **piobe**. A queue that cannot process a job because of this restriction will show a queue status of **DEV\_BUSY**. The status will change to **RUNNING** as soon as the **qdaemon** can acquire a lock on the file specified by the *file* parameter.

## Datastream flow for common print jobs

After a job has been submitted to the spooler for processing and after the **qdaemon** has accepted the job and determined that the job's turn to be processed has arrived, the backend for the queue is invoked.

The following figure illustrates the process of how **piobe** uses a shell to construct and manage a pipeline of filters to process the job. The flow of a job through this pipeline of filters, is:

1. backend (piobe) -- (receives arguments through the `argc` and `argv` subroutines from qdaemon).
2. shell
3. optional filter
4. **pioformat**
5. device-dependent code
6. **pioout**
7. device driver

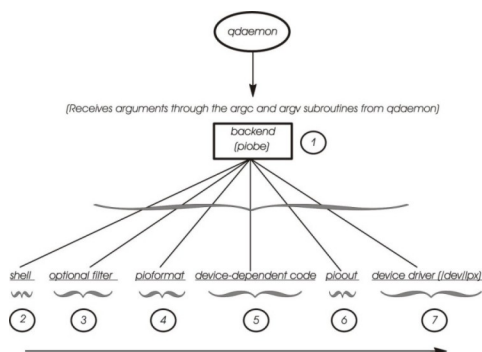

Figure 2. Datastream Flow for Common Print Jobs

When the device upon which the job is queued becomes available, the **qdaemon** invokes the backend for the queue. In the base operating system world, the backend is commonly **piobe**. The **qdaemon** invokes **piobe** and passes it arguments in the normal C programming language fashion, using `argc` and `argv[]`.

For example, using the command in step 2 from “Spooler data flow (enq command)” on page 48 :

```
qprt -Pasc -z1 -fp -p12 -s courier -C -N3 /etc/motd
```

**piobe** is passed the following arguments:

- `argc = 10`
- `argv[0] = /usr/lib/lpd/piobe`
- `argv[1] = -f`
- `argv[2] = p`
- `argv[3] = -z`
- `argv[4] = 1`
- `argv[5] = -p`
- `argv[6] = 12`
- `argv[7] = -s`
- `argv[8] = courier`
- `argv[9] = /etc/motd`

**argv[0]** is the name of the backend itself, as usual. Note that the `-Pasc`, which specifies the queue name, was parsed out of the original argument vector, as were the `-C` and `-N3` flags and arguments.

**piobe** uses the `argv[]` values to construct a pipeline of filters that must be executed to process the job as requested. After determining the structure of the pipeline, **piobe** passes the structure to a shell for realization. If the **file** parameter in the `/etc/qconfig` entry for this queue exists, **piobe** will open the stdout of the last process in the pipeline onto the value specified by the **file** parameter. The last process in the pipeline is not prevented from re-opening stdout onto some other file or device.

Note the parent-child relationship among these processes, which is not apparent from the figure:

- **qdaemon** is the parent of **piobe**.
- **piobe** is the parent of the shell.
- The shell is the parent of **pioout**, the last process in the pipeline before the device driver is accessed. **pioout** is called the *Interface Program for Use With the Device Driver* or the *device driver interface program*.
- **pioout** is the parent of **pioformat**.
- **pioformat** dynamically loads and links the device-dependent code at runtime; hence the device-dependent code does not appear as a process in the operating system's process table.
- **pioformat** is the parent of the optional filter (if it exists), such as the **pr** filter.

An optional filter, such as **pr**, can be specified on the command-line (or hardcoded in the colon file) to perform pre-filtering on the job before **pioformat** processes it.

**pioformat** is known as a device-independent formatter driver. It will dynamically load, link, and drive various device-dependent formatters to process jobs of a specific data stream type (for example, Postscript, ASCII, GL, or PCL).

Device-dependent code is designed to handle the unique properties of combinations of specific data streams and physical printers. Because combinations of data stream types and printers can be grouped into classes with common attributes, there are currently less than 20 device-dependent modules. These modules are loaded, linked, and driven by **pioformat** at run time.

**pioout** is the end of the job-processing pipeline, and is called the *device driver interface program*. The function of **pioout** is to take the processed data stream and deliver it to the device for which it was intended, generally a printer. In the typical local print queue environment, it is **pioout** that has its stdout opened onto the character special file in the `/dev` directory, as specified by the **file** parameter in `/etc/qconfig`.

This is the character special file in the `/dev` directory that provides access to the device driver for the printer hardware.

## Virtual printers and formatter filters

When the spooler queue backend is **pioibe**, the *formatter filter* is normally the next-to-last process in the pipeline of filters processing the print job. The formatter filter is composed of two pieces of code.

A formatter filter provides the capability of either formatting the input print file or passing it through unmodified, based on an input parameter. Even if the formatter passes the input file unmodified, it still sends printer commands to initialize the printer before the input file is printed and restores the printer after printing is complete.

As shown in the following figure, the formatter filter is made up of the following components:

- A device-independent formatter driver
- A device-dependent formatter

The first is the device-independent formatter driver, **pioformat**. The second is a device-dependent formatter, of which there are fewer than 20. Code is device-independent when its execution is in no way dependent upon specific hardware, such as a certain physical printer. Similarly, code is device-dependent when its execution is dependent upon specific hardware, again such as a certain printer. In the base operating system spooler's formatter filter, it is the device-dependent formatter that contains code designed to handle all of the properties of a particular physical printer or class of printers, including supported data stream, escape sequences, and control codes unique to that printer or printer class.

The device-independent **pioformat** is called a *formatter driver* because that is precisely what it does. When **pioformat** is set into execution, it expects several arguments. One of these arguments is the full path name to a device-dependent formatter. At run time, **pioformat** dynamically loads, links, and drives the device-dependent formatter. The following figure depicts this relationship.

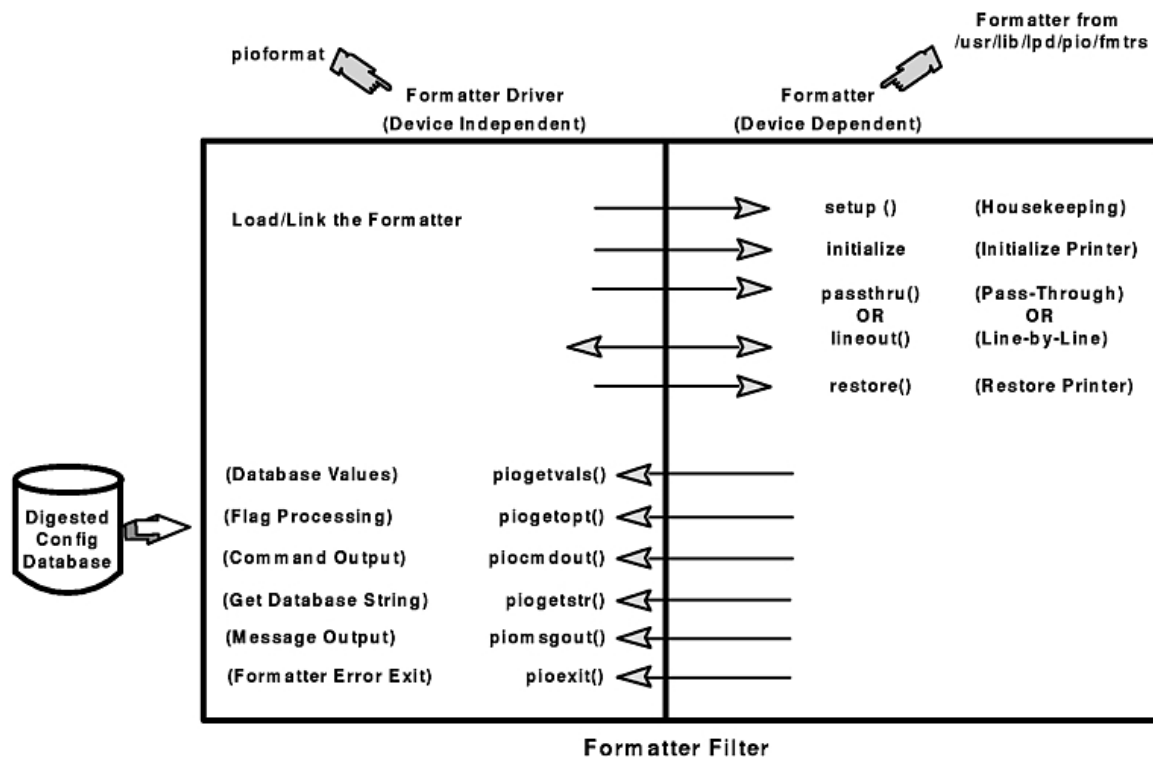

Figure 3. The Formatter Filter

The **pioformat** command expects to be able to call, if necessary, five subroutines; **pioformat** by itself does not contain these subroutines. The subroutines exist in the device-dependent formatter and are supplied to **pioformat** at runtime when the loading and linking of the device-dependent formatter by **pioformat** occurs.

The formatter driver is invoked by a pipeline and is passed the name of a formatter to be driven. The formatter driver dynamically loads and links the formatter and calls the formatter's **setup** function which indicates whether data formatting or data pass-through is requested. After the formatter's **setup** function performs the necessary functions, it returns to the formatter driver. The formatter driver calls the **initialize** function. The **initialize** function outputs a string of printer commands to initialize the printer and returns to the formatter driver.

The formatter driver either calls the **passthru** function once or calls the **lineout** function for each line in the print file based on the return code from the **setup** function. If the **lineout** function is called, the formatter driver performs all vertical spacing, including line spacing, vertical tabs, form feeds, and top and bottom margins. Line spacing and vertical tabs are performed by the **lineout** function. Other vertical spacing functions are performed automatically.

When processing is complete, the formatter driver calls the **restore** function. The **restore** function outputs a string of printer commands to restore the printer to its default state, defined by the database attribute values.

For more information about how the print formatter interacts with the printer formatter subroutines, see the [“Print formatter example”](#) on page 76.

## **/etc/qconfig spooler configuration file**

---

The `/etc/qconfig` file describes all of the queues defined to the base operating system.

A queue is a named, ordered list of requests for a specific device. A device is something (either hardware or software) than can handle those requests one at a time. The queue provides serial access to the device. Each queue must be serviced by at least one device; often it can be handled by more than one device.

### **/etc/qconfig file structure**

The `/etc/qconfig` file is the most important file in the spooler domain.

- The `/etc/qconfig` file contains the definition of every queue known to the spooler.
- A system administrator can read the `/etc/qconfig` file and discern the function of each queue.
- Although it is not recommended, the `/etc/qconfig` file can be edited (see [“/etc/qconfig File”](#) on page 134) to modify spooler queues without halting the spooler.

The **qdaemon** reads the ASCII version of `/etc/qconfig` and creates a binary version, `/etc/qconfig.bin`. `/etc/qconfig` must adhere to a specific structured format in order for the **qdaemon** to be able to parse it. This format is detailed in the `/etc/qconfig File Structure` examples below.

```

Local Queue
queue_name:
    device = device_name
    up = TRUE or FALSE
    discipline = fcfs or sjn
device_name:
    file = physical_device_name or FALSE
    header = always or group or never
    trailer = always or group or never
    access = both or write
    backend = full_path_name_to_backend_program
```

```

Remote Queue
queue_name:
    device = device_name
    up = TRUE or FALSE
    host = remote_hostname
    s_statfilter = full_path_to_short_filter
    l_statfilter = full_path_to_long_filter
    rq = remote_queue_name
device_name:
    backend = full_path_name_to_backend_program
```

/etc/qconfig is composed of text blocks referred to as stanzas. Each queue is represented by a pair of stanzas. The first stanza in a pair is referred to as the queue stanza; the second stanza in a pair is referred to as the device stanza. Stanzas are composed of parameters and parameter values that describe the queue's properties and function.

When the **qdaemon** parses the ASCII version of /etc/qconfig, the first non-commented line it identifies must be a word followed by a colon; this line represents the beginning of the queue stanza. This word is the name of a queue to which a user can submit jobs. There must be one or more lines indented by tabs following this line. One of these lines must be `device = device_name`. The value of the **device** parameter is a link from the queue stanza to the device stanza; this parameter has no other function. When a queue is initially setup, the operating system will frequently use the name of a printer, such as **lp1**, as the value of the **device** parameter. While the queue may actually be setup to use **lp1**, the use of **lp1** as the value of the **device** parameter only means that the device stanza will be named **lp1**. This is not related to the fact that there is a real printer known to the operating system as **lp1**.

Following the tab-indented lines, the qdaemon must find the word that is the value of the **device** parameter followed by a colon; this line represents the beginning of the device stanza. This word, which a user normally does not need to know, is the name of a device to which the corresponding queue stanza provides serial access. There must be one or more lines indented by tabs following this line. One of these lines must be `backend = full_path_name_to_backend`. In a local spooling environment, there are two parameters of critical importance in this stanza.

The **file** parameter specifies the real device to which the queue provides serial access. It is important to note that jobs submitted to the spooling system are queued upon this device. If a queue is setup to use a printer known to the operating system as **lp1**, then the value of the **file** parameter would be /dev/lp1. The operating system routines that create queues use the name of the real device as the name of the device stanza by default, and this is why there is some confusion as to the meaning of the **device** parameter.

The **backend** parameter specifies the full path to the program that will process the job submitted to the spooling system, after the **qdaemon** determines that the job's turn to be processed has arrived.

## Spooler queues, virtual printers, and physical printers

These examples for /etc/qconfig file structure are provided for defining queues, virtual printers and physical printers.

This *Four Queues - Four Virtual Printers - One Physical Printer* example depicts an instance of /etc/qconfig that defines four queues on a single physical printer, in this case /dev/lp1. Notice that all four pairs of stanzas use the string **lp1** to connect a queue stanza to a device stanza. It is the **file** parameter in each device stanza that specifies that the printer known to the base operating system as **lp1**, and whose device driver entry point is /dev/lp1, is the actual physical destination of any jobs submitted to any of these queues. When these queues were defined with SMIT, the command that actually creates the queue definition needed a string to connect the two halves of each stanza pair. Because the physical printer at hand was **lp1**, the string **lp1** was used as the both the value of the **device** parameter in each queue stanza and as the name of each device stanza. This format is detailed in the */etc/qconfig File Structure* examples below.

```
asc:
    device = lp1
lp1:
    file = /dev/lp1
    header = never
    trailer = never
    access = both
    backend = /usr/lib/lpd/piobe
```

```
gl:
    device = lp1
lp1:
    file = /dev/lp1
    header = never
    trailer = never
```

```
access = both
backend = /usr/lib/lpd/piobe
```

```
pcl:
lp1:
    device = lp1
    file = /dev/lp1
    header = never
    trailer = never
    access = both
    backend = /usr/lib/lpd/piobe
```

```
ps:
lp1:
    device = lp1
    file = /dev/lp1
    header = never
    trailer = never
    access = both
    backend = /usr/lib/lpd/piobe
```

Each of these stanza pairs defines a queue. When the backend for a queue is **piobe**, each queue also has an associated virtual printer. While it is possible to create virtual printer definitions the hard way, virtual printer definitions are typically created at the same time as the queue definition, with SMIT and the **piomkpp** command. The virtual printer definition is not contained in `/etc/qconfig`. Its presence is implied by the fact the spooler backend for a given queue is **piobe**, but it is stored elsewhere in the base operating file system. The name of the queue is used to identify and access the virtual printer definition.

The physical printer known to the base operating system as **lp1** clearly supports at least four distinct data stream types; they are ASCII (**asc**), Plotter Emulation (**gl**), Printer Command Language (**pcl**), and PostScript (**ps**). Each queue with its associated virtual printer definition is designed to process a particular data stream type, hence the four queues. This is the basis for the base operating system notion of a logical separation of physical and virtual printers.

## Spooler queue names and status formats

Spooler queue names (the name of a queue stanza) can be over seven characters in length but only the first seven characters will be displayed in the output of a queue status query. Device names (the name of a device stanza) are limited to five characters in the output of a queue status query.

In spooler queue status queries, remote spooler queues will be indicated twice: once for the local queue, and once for the remote queue on the print server. For example, if `/etc/qconfig` contains this entry:

```
myps:
    device = @kriquet
    up = TRUE
    host = kriquet
    s_statfilter = /usr/lib/lpd/aixshort
    l_statfilter = /usr/lib/lpd/aixlong
    rq = myps
@kriquet:
    backend = /usr/lib/lpd/rembak
```

The command **lpstat -pmyps** would return the following:

Queue	Dev	Status	Job Files	User	PP %	Blks	Cp	Rnk
myps	@krik	READY						
myps	myps	READY						

The first line of the output indicates that the local spooler queue named **myps**, with a device stanza whose name is listed as **@krik**, has a status of **READY**. The second line indicates that the target remote spooler queue, also named **myps**, whose device stanza is listed as **myps**, also has a status of **READY**. (It is the author's habit to make a local spooler queue name the same as the print server spooler queue name. It's then easy to visually group the two lines in the output of a spooler queue status query.)

## Printer backend programming

---

The printer backend is a standard feature of the base operating system.

The base operating system printer backend receives and processes print requests from a spooler, usually the **qdaemon** command. The printer backend is implemented by the **piobe** command

The printer backend supports all of the printers installed in the Object Data Manager (ODM) Predefined database. You can customize the printer backend to assist in the administration of the printing subsystem. For more information, see “Printing administration” on page 14. You can also modify the printer backend to add unsupported printers and National Language Support (NLS) code page translation tables.

Adding a printer to the printer backend involves adding a printer colon file for that printer. In many cases, the printer colon file of a similar printer can be duplicated with little modification. If modification of an existing printer colon file is not sufficient, you can write a print formatter. If the modifications exceed the scope of the print formatter, you may need to write a new printer backend.

See the following sections for more information:

- “Adding a printer using the printer colon file” on page 99 provides a procedure for duplicating a printer colon file.
- “Printer colon file escape sequences” on page 65 provides information useful in modifying a printer colon file.
- “Back-end routines in libqb” on page 83 and “Backend and qdaemon interaction” on page 79 can assist you in writing a new printer backend.

The procedure for translating NLS code points in the print file to code points for the printers varies depending upon whether the code sets are single-byte or multibyte. For more information, see:

- “Printer code page translation tables” on page 85
- “Printer code page translation for multibyte code sets” on page 85

Third-party vendors may want to customize the printer backend for special purposes.

### Printer backend data flow

The primary purpose of a backend is to send characters to a device, usually a printer.

The printer backend is invoked once for every file or group of files to be printed, with the name of each file passed to the backend as a parameter. The backend opens the file, reads it, and sends it to the device. The recommended method for a backend to operate is to write to its standard output, with the **qdaemon** process opening the device onto the correct file descriptor. This requires setting the **file** field in the **qconfig** file.

The name of the file to be printed can be a direct or relative path name. The user ID and group ID of the backend are those of the process that invoked the **enq** command.

When a backend is invoked, it has access to the user's environment. To access the user's environment, the backend may invoke the **getenv** subroutine (see the **getenv** subroutine for more information). For example, to access the user's directory, **getenv(PWD)** returns a pointer to the directory name. The backend can use this to read from or write to this directory.

If the backend writes to its standard output, the **qdaemon** opens the device in root-user mode. If the backend needs to open the device itself, it must have the correct permissions to open the device. Because the backend runs under the permissions of the user sending the print job, you may need to change the protections on the device or install the backend set-user-ID or set-group-ID.

By default, **stdin**, **stdout**, and **stderr** are all open to the null device (`/dev/null`), although it is possible to override the setting of **stdout** (and possibly **stdin**) with the **file** and **access** fields in the **qconfig** file.

## Virtual printer definitions and attributes

A *virtual printer definition* is a file that pairs the attributes or characteristics of a specific printer with the attributes of a specific data stream type.

If a specific printer supports more than one data stream type, you must create a virtual printer definition, pairing the attributes of the printer with each data stream type. Thus, if a printer supports both ASCII and PostScript data streams, you must create two virtual printer definitions for the printer.

The *colon* file stores the virtual printer definition for a printer or plotter. Colon files reside in the predefined and customized database directories. The printer backend uses the attribute values stored in colon files to format print requests.

All attribute values reside in colon files as character strings, regardless of whether they represent strings, integers, or Booleans. An attribute value can contain embedded references to other attribute values or embedded logic that dynamically determines the content of the value.

For more information on colon files and how embedded references and logic are used in attribute strings, see [“Printer colon file conventions”](#) on page 71 and [“Printer colon file escape sequences”](#) on page 65.

### Virtual printer attributes

The commands used to create a virtual printer (the **mkvirprt** or **smit virprt** commands) copy a predefined virtual printer definition and create a customized virtual printer definition for the specified queue and queue device.

The attribute values in the custom definition can be further changed, with the **chvirprt** or **smit lsvirprt** commands.

You must create a virtual printer for each data stream type supported by a specific printer device. The supported data stream types include:

Data Stream Type	Code for Attribute Name/Value	Description
asc	a	Extended ASCII
pcl	c	Hewlett-Packard PCL
630	d	Diablo 630
gl	g	Hewlett-Packard GL
	p	Pass-through (sent to printer unmodified)
ps	s	PostScript
855	a	Texas Instruments 855
kji	k	Kanji

When you use the **mkvirprt** or **smit virprt** command to create a virtual printer, the system prompts you to select the desired printer from a list of defined printers. If you have just configured a printer port for a new printer, select the new printer port. When the virtual printer command is executed, the system creates a print queue and copies the colon file for the selected printer in the predefined database directory, `/usr/lib/lpd/pio/predef/*`, to the customized database directory `/var/spool/lpd/pio/custom/*`.

**Note:** If no flags are specified, the **mkvirprt** command becomes interactive.

Use the **chvirprt** or **smit lsvirprt** command to change or further customize the attribute values stored in a virtual printer definition. To change an attribute value with **smit lsvirprt**, enter `attribute_name=attribute_value` with no spaces on either side of the = (equal) sign.

Each attribute name in a virtual printer definition must be unique. Attribute names can contain the characters **a** through **z**, **A** through **Z**, **0** through **9**, and **\_** (underscore). Attribute names must not begin with

a numeral. All attribute names must be two characters long, except for group header attribute names, which can be five characters long.

Attribute names for group headers begin with `__` (two underscores) and must not be longer than five characters. A group header attribute marks the beginning of a group of related attributes.

Examples show some of the typical attributes for a supported PostScript laser printer (4029 LaserPrinter). Each example shows how the `lsvirprt` and `smit lsvirprt` commands display virtual printer attributes (with a descriptor for each attribute) and how those same attributes are stored in the printer colon file.

## Default virtual printer flag value attributes

Default flag value attributes are grouped under the `__FLG` group header attribute.

If a flag corresponding to the attribute is used with a print command, values for these attributes are overridden from the command line. For example, the `_l` attribute in a virtual printer definition contains a value for the number of lines to print on a page. Assume that the default value stored in the `_l` attribute is 66. The following print request does not specify a number of lines per page with the `-l` flag:

```
qprt -P Pro myfile
```

The printer subsystem uses the default `_l` value of 66 to process the print request. The following print request uses the `-l` flag to specify 50 lines of text per page:

```
qprt -l 50 -P Pro myfile
```

The `-l` flag value overrides the default value in the `_l` attribute of the virtual printer definition for the `Pro` printer.

The first character for a default flag value attribute is always the `_` (underscore). The second character corresponds to the command flag for which the default value is stored.

The following example shows some of the attribute values under the `__FLG` group header. These values are typical for a supported PostScript laser printer.

Name	Description	Value
<code>__FLG</code>	VALUES THAT MAY BE OVERRIDDEN WITH FLAGS ON THE COMMAND LINE	
<code>_1</code>	Page Headings Wanted For Text Converted to PostScript? (!: no; +: yes)	!
<code>_2</code>	Use Two Columns for Text Converted to PostScript? (!: no; +: yes)	!
<code>_3</code>	Gaudy Mode Wanted for Text Converted to PostScript? (!: no; +: yes)	!
<code>_4</code>	Print Garbage File Anyway for Text Converted to PostScript? (!: no; +: yes)	!
<code>_5</code>	List Characters Not In Font When Converting Text to PostScript? (!: no; +: yes)	!
<code>_6</code>	Font Name for Header Line of Text Converted to PostScript	300
<code>_A</code>	stderr returned? 0:no; 1:yes, & pipelines; 2:yes, & values, pipelines	1
<code>_H</code>	Name To Replace Host Name On Burst Page	
<code>_J</code>	Restore the Printer at the End of the ? Print Job (!: no; +: yes)	+
<code>_L</code>	Wrap Long Lines (!: no; +: yes)	+

The preceding attributes are stored in the colon file as:

```
:056:__:FLG::  
:466:_1:!  
:467:_2:!  
:469:_3:!  
:470:_4:!  
:471:_5:!  
:472:_6::300  
:013:_A::1  
:022:_H::
```

```
:027:_J::+
:030:_L::+
```

## Virtual printer system administration attributes

The **\_SYS** group header attribute stores values for attributes such as the **sh**, **si**, and **st** attributes. The **sh** and **st** attributes store the pipelines for the header page and the trailer page.

The **si** attribute identifies who receives printer-intervention messages when the printer needs attention. A null string specifies that intervention messages should go to the user who submitted the print job. Separate user names with a comma. Use the SMIT Virtual Printers option or the **chvirprt** command to change the attribute as needed.

For example, **si=** specifies that the user who submitted the print job should receive the messages, **si=mary** specifies the user **mary** should receive the messages, and **si=,jim@server02** specifies that both the user who submitted the print job and **jim** at node **server02** should receive intervention messages.

The first character for a system administration attribute is **s**.

Some typical **\_SYS** attributes for a supported PostScript laser printer are:

```
_ _SYS OTHER VALUES OF INTEREST TO THE SYSTEM
ADMINISTRATOR
sh      Pipeline for Header Page          %Ide/pioburst
                                             %F[H] %Idb/H.p
                                             s | %Ide/piofo
                                             rmat -@%Idd/%I
                                             mm -!%Idf/piof
                                             pt%f[j]

si      Users, Separated by Commas, to Get Intervention
Messages; Null String Is Job Submitter
sp      Command Line Flags Prohibited For All -d values;
Ignored: cmnrBDMprt
st      Pipeline for Trailer Page        %Ide/pioburst
                                             %F[H] %Idb/T.p
                                             s | %Ide/piofo
                                             rmat -@%Idd/%I
                                             mm -!%Idf/piof
                                             pt%f[j]

sw      Width of Attribute Value Area On Header Page
(0 means ignore width)                78
```

These same attribute values would be stored in the printer colon file as:

```
:060:_ _SYS::
:321:sh::%Ide/pioburst %F[H] %Idb/H.ps | %Ide/pioformat -@%Idd/%Imm
-!%Idf/piofpt %f[j]
:322:si::
:323:sp::
:324:st::%Ide/pioburst %F[H] %Idb/T.ps | %Ide/pioformat -@%Idd/%Imm
-!%Idf/piofpt %f[j]
:325:sw::78
```

## Virtual printer input data stream attributes

The **\_IDS** group header attribute heads the list of attributes that store pipelines for different input data streams.

Some of the attributes in this group are the **ia** attribute that stores the extended ASCII input data stream pipeline, and the **is** attribute that stores the PostScript input data stream pipeline. The **ip** attribute is another typical attribute in this group. The **ip**, or pass-through, attribute passes the output from a formatter filter to the printer unmodified.

The first character for an input data stream attribute is **i**. The second character designates the input data stream type.

The following example of **\_IDS** attributes shows typical input data stream pipelines for a supported PostScript laser printer (4029 LaserPrinter).

```

_ _IDS PIPELINES FOR INPUT DATA STREAMS (2 char, 1st="i",
      2nd=data stream name)
ia      Pipeline for Input Data Stream "a" (extended ASCII) /usr/bin/enscr
ipt -p- -q??%G
_2?t -2%;??%G_
z?t -r%;??%G_3
?t -G%;??%G_1
?t%e -B%;??%G_L
?t%e -c%;??%Ch
?t%fbh%e%?%L_h
?t -b'I_h'%;%;
; -L%G_1%d -f%
??Cs%t%f!s%e%I
_s%;%G_p%d %?%
G_1?t-F%Iw7%G_
p%d%;??%G_4?t
-g%;??%G_5?t -
o%;??%L_f?t%e
%I@1%; | %Iis
il      Command Line Flags Prohibited For Input Data /interleaf/ile
Stream; Ignored: cmnrBDMPT af5/bin/pl2ps
PPD -r 1270 -nf
-np | %Ide/pio
format -@%Idd/
%Imm-!%Idf/pio
fpt %f[juJZ]
in      Pipeline for Input Data Stream "n" (troff /usr/bin/psc |
(ditroff) intermediate output) s%Ii
ip      Pipeline for Input Data Stream "p" %Iis
(pass-through)
is      Pipeline for Input Data Stream "s" (PostScript) %Ide/pioformat
-@%Idd/%Imm-!
%Idf/piofpt %U
H %f[juJZ]

```

The colon file stores these same attributes in the following format:

```

:057:_ _IDS::
:274:ia::/usr/bin/enscript -p- -q??%G_2?t -2%;??%G_z?t -r%;??%G_3?t
-G%;??%G_1?t%e -B%;??%G_L?t%e -c%;??%Ch%t%fbh%e%?%L_h?t -b'I_h'%;%;
-L%G_1%d -f%??%Cs%t%f!s%e%I_s%;%G_p%d %?%G_1?t-F%Iw7%G_p%d%;??%G_4?t
-g%;??%G_5?t -o%;??%L_f?t%e %I@1%; | %Iis
:001:il::/interleaf/ileaf5/bin/pl2ps -ppd IBM17521.PPD -r 1270 -nf -
np | %Ide/pioformat -@%Idd/%Imm-!%Idf/piofpt %f[juJZ]
:465:in::/usr/bin/psc | %Iis
:277:ip::%Iis
:273:is::%Ide/pioformat -@%Idd/%Imm-!%Idf/piofpt %UH %f[juJZ]

```

## Attributes of virtual printer prohibited flags

The attributes grouped under the `_ _PFL` group header attribute store the names of command flags to be rejected by the printer backend for a particular data stream.

If you use a prohibited command flag in a front-end print request (such as `qprt`), the system rejects the flag and returns a message that the flag is prohibited by system administration. The first character of a prohibited flag attribute name is **I** and the second character represents the data stream type to be rejected.

To prohibit multiple flags for a data stream type, store the single-character flag names with no spaces, commas, or other delimiters. For example, to reject the `-e` (emphasized print) flag and the `-E` (double-high print) flag for the extended ASCII input data stream, run the `smit lsvirprt` command and enter the following to set this attribute:

```
Ia=eE
```

The following example shows the **Is** attribute that sets the prohibited flag attribute for the PostScript data stream on a supported PostScript printer. The descriptor for the **Is** attribute contains the string **Ignored: cmnrBDMPT**. This string indicates that the backend ignores the flags represented by the individual characters `cmnrBDMPT`. These flags are flags that address the spooling subsystem, not the backend. Thus, listing one of these flags as a prohibited flag has no effect on the backend; the flag is not prohibited.

```
_ _PFL FLAGS PROHIBITED FOR INPUT DATA STREAMS (2
  char,1st="I",2nd=data str name)
Is      Command Line Flags Prohibited For Input Data
        Stream; Ignored: cmriBDMPRT
```

The colon file stores the attributes in the preceding example as follows:

```
:059:_ _PFL::
:001:Is::
```

## Virtual printer filter flag attributes

Attributes grouped under the `_ _FIL` group header attribute store command strings for text filter flags.

The first character of the attribute name is always **f** and the second character denotes the type of filter. Filter flags, such as `-p` and `-n` specify to the backend program the type of filter used to format the print job. Filter attribute designations are:

### Ite

#### m Descriptor

- `fp` **pr** filter
- `fn` Formats files containing *ditroff* (device-independent *troff*) data
- `fl` Prints control characters and suppresses page breaks
- `ft` Formats files containing data produced with **troff** commands
- `fd` DVI filter formats files created with **tex**
- `fg` Formats standard plot data files (files created with **plot**)
- `fv` Formats raster image files
- `fc` Formats files containing data produced with **cifplot**
- `ff` Interprets the first character of each line as a FORTRAN carriage control character.
- `fb` Determines the locale support for Arabic and Hebrew. Must be `/usr/bin/bprt`. The width must be set to **80** and the data stream set to **a** for extended ASCII. Add the flag `-tashkeel` to print documents with diacritics.

The value stored in a filter attribute designates the command string for the specified filter. Entries for a supported PostScript laser printer can include:

```
_ _FIL COMMAND STRINGS FOR FILTER FLAGS (2 char,
  1st="f",2nd=flag)

fn      Command String for the "n" Filter.          /usr/bin/psc
fp      Command String for the "p" Filter          /bin/pr -l%G_l
fb      Command String for the "b" Filter.          /usr/bin/bprt
                                                -w%I_w -d%I_d
                                                -tashkeel
```

These same attribute values are stored in the colon file as follows:

```
:055:_ _FIL::
:269:fn::/usr/bin/psc%is
:270:fp::/bin/pr -l%G_l%d -w%G_w%d%F[h] %I@1%ia
```

The **fd** attribute is a typical filter attribute. It is used to specify a DVI filter for the virtual printer. Use `SMIT` or the **chvirprt** command to specify this filter. For example, to specify a DVI filter by using `SMIT`, enter:

```
smit lsvirprt
```

Select the desired virtual printer and enter the following:

```
fd=/usr/bin/dvi_to_printer%ip
```

where *dvi\_to\_printer* specifies the full pathname of the filter that converts the DVI output from **tex** to the format expected by the printer. The %ip designation forces the pass-through pipeline (the **ip** attribute) to be used to process the print file instead of the ASCII pipeline (**ia** attribute). The pass-through pipeline causes the output from the filter to be passed to the printer unmodified.

After the DVI filter has been specified in the **fd** attribute, you can send a print command such as **lpr -d DviFile** or **qprt -fd DviFile**. The **-d** and **-fd** flags for the respective commands pass *DviFile*, an output file produced by **tex**, through the DVI filter and send the results to the printer.

## Virtual printer directory attributes

Directory attributes are grouped under the **\_\_DIR** group header attribute. These attributes store path names to various files needed to process print requests, such as translate tables, files containing header and trailer page text, downloadable font files, and temporary files.

The first character in a directory attribute name is **d**, and the second character designates the directory.

The following example shows some of the directory attribute values for a supported PostScript laser printer:

```
__DIR DIRECTORIES
d1 Directory Containing Stage 1 Translate Tables (data stream to intermed.) /usr/lib/lpd/pio/trans1
d2 Directory Containing Stage 2 Translate Tables (intermediate to printer) /usr/lib/lpd/pio/trans2
dD Directory Containing Dummy Device Files For Printers Driven By, But Not Attached To, the dev Host Computer /usr/lib/lpd/pio/
dF Directory Containing Flags files (keeps track of loaded fonts) /var/spool/lpd/pio/@local/flags
```

The same attribute values are stored in the colon file as:

```
:053:__:DIR::
:160:d1::/usr/lib/lpd/pio/trans1
:161:d2::/usr/lib/lpd/pio/trans2
:509:dD::/usr/lib/lpd/pio/dev
:414:dF::/var/spool/lpd/pio/@local/flags
```

## Virtual printer miscellaneous attributes

The **\_\_MIS** group header attribute groups miscellaneous printer attributes. Miscellaneous attributes begin with the letter **m** and store values such as the printer description and printer model number.

The device name and queue name are also stored in the miscellaneous group. The **mn** attribute stores the device name and the **mq** attribute stores the queue name.

Here are some typical miscellaneous attributes for a supported PostScript laser printer:

```
__MIS MISCELLANEOUS
mA Printer Data Stream Description PostScript
mD Name of message catalog Containing Attribute Descriptors pioattr1.cat
mF Path Name of Font File To Be Downloaded (must include download commands)
mL Printer Description IBM 4029 Laser Printer
mN Printer model number 029
mY Datastream Mode to Which Printer is Restored at End of Job (0: IBM PPDS; 1: HP PCL; 2: Plotter; 3: PostScript) 3
mc String to Send to Printer "mz" Times When Job Is Cancelled \0
```

md	Output Data Stream Type (example: ascii); Initialized By "piodigest"	ps
mf	Path Name of the Default Formatter (used when running standalone)	%Idf/piofpt
mi	Input Data Stream Names (1 character, separated by commas) for mp Attribute	s,l
mm	File Name Of (Digested) Data Base; Init. By "piodigest" (mt.md.mn.mq:mv)	
mn	Device name (example: lp0); Initialized By "piodigest"	lp1
mo	Command String to Invoke Device Driver I/F Program (end of pipeline)	%Ide/pioout %v [ABCDFINOPRS]
mp	Strings (separated by commas) That Identify Print File Data Types (see mi)	%%!,\3200PS
mq	Queue Name; Initialized By "piodigest"	ps1

These same attributes are stored in the colon file in the following format:

```
:058:_ _MIS::
:330:mA::PostScript
:332:mD::pioattr1.cat
:287:mF::
:331:mL::IBM 4029 LaserPrinter
:295:mN::4029
:516:mY::3
:301:mc::\0
:302:md::ps
:303:mf::%Idf/piofpt
:304:mi::s,l
:305:mm::
:306:mn::lp1
:307:mo::%Ide/pioout %v[ABCDFINOPRS]
:308:mp::%%!,\3200PS
:309:mq::ps1
```

## Virtual printer work variable attributes

Work variable attributes (values change while formatting) begin with the letter *w* and are listed under the **\_ \_WKV** group header attribute.

Some typical work variable attributes for a supported PostScript printer are:

<b>_ _WKV WORK VARIABLES</b>		
w7	Font Name for Header Line of Text Converted to Postscript	%%?%S_s%"Courier" %=%tCourier- Bold%e%S_s%"Ti mes-Roman"%=%t Times-Bold%e%S _s%"Helvetica" %=%tHelvetica- Bold%e%S_s%"Ti mes-Italic"%=% tTimes-BoldIta lic%e%S_s%"Hel vetica-Oblique "%=%tHelvetica -BoldOblique% %Iw8%;
wl	Smallest legal sheetfeeder drawer number	0
wu	Largest legal sheetfeeder drawer number	3

The colon file stores these same values as:

```
:062:_ _WKV::
:472:w7::%%?%S_s%"Courier"%=%tCourier-Bold%e%S_s%"Times-Roman"%=%tTimes-Bold%e%S_s%"Helvetica"%=%tHelvetica-Bold%e%S_s%"Times-Italic"%=%tTimes-BoldItalic%e%S_s%"Helvetica-Oblique"%=%tHelvetica-BoldOblique%eIw8%;
:370:wl::0
:381:wu::3
```

## Virtual printer command aggregate attributes

Command aggregate attributes, grouped under the **\_ \_CAG** group header attribute, store values such as the command to initialize the printer and the command to restore the printer after a print job is completed.

Attributes in this category begin with the letter **c**. Typical command aggregate attributes for a supported PostScript printer are:

```
_ _CAG COMMAND AGGREGATES
ci      Command To Initialize the Printer      %Iez\4%?%G_j%{
1}%=%tstatusdi
ct begin%Iat %
Iar %?%Gmw%t%I
aF%; end%;
cr      Command To Restore the Printer at Job End %o\4%Iex
```

These same attributes are stored in the colon file as:

```
:051:_ _CAG::
:144:ci::%Iez\4%?%G_j%{1}%=%tstatusdict begin %Iat %Iar %?%Gmw%t%IaF
%; end%;
:152:cr::%o\4%Iex
```

## Virtual printer ASCII control code attributes

The **\_ \_CTL** group of virtual printer attributes store ASCII control codes used by the printer.

These attributes begin with the letter **a** and store values such as the control code used to advance paper to the next page. The following control codes are typical for a supported PostScript printer:

```
_ _CTL CONTROL CODES (ASCII)
aF      PostScript Command to Set Simplex/Duplex and %?%G_Y%ttrue
Tumble Mode duplex %?%G_Y%
{1}%=%tfalse t
umble%ettrue tu
mble%;%efalse
duplex%;
af      ASCII Control Code to Advance the Paper to showpage
Top of Next Page (FF)
ar      Cannot access message catalog pioattr1.cat. %G_6%d setreso
lution
at      Cannot access message catalog pioattr1.cat. %G_u%d setpape
rtray
```

The colon file stores these attributes as follows:

```
:052:_ _CTL::
:512:aF::%?%G_Y%ttrue duplex %?%G_Y%{1}%=%tfalse tumble%ettrue tumble
%;%efalse duplex%;
:113:af::showpage
:119:ar::%G_6%d setresolution
:115:at::%G_u%d setpapertray
```

## Virtual printer escape sequences attributes

Escape sequence attributes begin with the letter **e** and are grouped under the **\_ \_ESC** group header attribute.

Typical PostScript printer values are:

```
_ _ESC ESCAPE SEQUENCES
ex      Command to Restore Printer Datastream Mode \33[K\3\0\4\61
(used only on restore) %?%GmY%{2}%>%t
%{8}%c%e%GmY%{
1}%+%c%;
ez      (used only on init/restore) Set initial \33[K\5\0\4\61
conditions \10\0\0
```

These same values are stored in the colon file as:

```
:054: _ _ESC::  
:514:ex::\33[K\3\0\4\61%?%GmY%{2}%>%t%{8}%c%e%GmY%{1}%+%c%;  
:263:ez::\33[K\5\0\4\61\10\0\0
```

## Printer colon file escape sequences

Embedded references and logic for attribute values in the printer backend's database colon files are defined with escape sequences placed at appropriate locations in the attribute string.

These escape sequences are not to be confused with printer escape sequences. The first character of each escape sequence is always the **%** (percent sign) character, which indicates the beginning of an escape sequence. The second character (and sometimes subsequent characters) define the operation to be performed. The remainder of the characters (if any) in the escape sequence are operands used to perform the specified operation.

Calculations performed by the escape sequences can use a stack to hold integers or pointers to strings to be operated on and can use internal variables **a** through **z** to save integer values for later use.

Because the **%** character is used to define the beginning of an escape sequence, a **%** character that is part of the data must be represented in the database as two adjoining **%** characters (**%%**). Only one **%** character appears in the constructed string.

The escape sequences that can be specified in an attribute string are listed and described in the following table. They are based on the `terminfo` file escape sequences for terminals, which have been modified and extended for printers.

Table 1. File escape sequences

Esc. Seq.	Description
%%	Generates a <b>%</b> (percent sign) character.

### ASCII Output from Stack:

Table 2.

Item	Descriptor
<b>%d</b>	Pops an integer value from the stack and converts it to ASCII, without leading zeros. Produces a field width large enough to hold the ASCII numeric digits. Similar to <b>%d</b> with the <code>printf</code> subroutine.
<b>%[1-9]d</b>	Pops an integer value from the stack and converts it to ASCII. The result is 1 to 9 characters long, depending on the digit specified before the <b>d</b> . If the value does not fill the specified field width, it is padded on the left with zeros. If the value will not fit in the field, excess high-order digits are discarded. For example, with a value of <b>243</b> from the stack, <b>%4d</b> produces <b>0243</b> and <b>%2d</b> produces <b>43</b> . A stack value of <b>-243</b> would cause <b>%5d</b> to produce <b>-0243</b> .

### Binary Output from Stack:

Table 3.

Item	Descriptor
<b>%c</b>	Pops an integer value from the stack and discards all but the low-order byte.
<b>%h</b>	Pops an integer value from the stack and discards all but the two low-order bytes.

Table 3. (continued)

Item	Descriptor
<b>%a</b>	Similar to <b>%h</b> , except that the two bytes from the stack are in an alternate order: low-order byte, then high-order byte.

**Input String:**

Item	Descriptor
<b>%Ixx</b>	Includes the string attribute whose name is <b>xx</b> . <b>%I</b> and can be used recursively; that is, the included string can also contain a <b>%I</b> . Note that the included string does not inherit the current stack. Instead, it is assigned a new stack.
<b>%I[ . . . ]</b>	If multiple, contiguous includes are to be done, the attribute names can be separated by commas and enclosed with brackets. For example, the string <b>%Icp%Icc%IeW</b> can be specified as <b>%I[cp,cc,eW]</b> .
<b>%Dxx</b>	Downloads to the printer the contents of the file whose full path name is specified by the <b>xx</b> attribute. The print job must have read access to the file. The primary use of this operator is to download fonts to a printer.
<b>%"sss"</b>	Pushes a pointer to the <b>sss</b> string constant onto the stack. The only operation that can be performed on the string pointer is to use <b>%=</b> to compare the string with another string whose pointer is also on the stack.
<b>%`xx</b>	Inserts the standard output produced when the command string specified by the <b>xx</b> attribute is passed to a shell. Note that <b>`</b> is the grave accent character.
<b>%' "String "</b>	Passes the quoted string as a command to a sub shell. Any double quotation marks within the quoted string must be back-quoted to prevent the internal quotes from being read as delimiters for the string. Note that <b>`</b> is the grave accent character.

Input Integer To Stack

## Input Integer To Stack:

---

Item	Descriptor
<b>%#xx"..@.."</b>	<p>Extracts a selected portion of the string attribute named <b>xx</b>. The selection criteria is defined by the pattern <b>"...@..."</b>. The selection pattern consists of three parts:</p> <ol style="list-style-type: none"><li>1. The string immediately preceding the string to be extracted. If the prefix regular expression is missing, the extracted string consists of the entire string preceding the pattern specified by the suffix regular expression.</li><li>2. The extracted string replaces the <b>%#xx"..@.."</b> operation sequence in the attribute currently being processed.</li><li>3. The string immediately following the string to be extracted. If the suffix regular expression is missing, the extracted string consists of the entire string following the pattern specified by the prefix regular expression.</li></ol> <p>No string is extracted if the value of the string attribute is null. No string is extracted if the prefix or suffix regular expression is nonnull and does not have a corresponding match in the attribute value string.</p> <p><b>Note:</b> The ampersand (@) and quote ( " ) characters need to be surrounded with a separate pair of quotes if their meaning is to be taken literally. Otherwise, the program reads these symbols as delimiters.</p> <p>When embedding a <b>%#</b> operator within a regular expression portion of another <b>%#</b> operator, the ampersand ( @ ) and quote ( " ) characters cannot be used for their literal meaning. To avoid this situation, place the embedded <b>%#</b> operator in a separate attribute value and include the new attribute within the regular expression of the outer <b>%#</b> operator.</p>
<b>%Gxx</b>	<p>Gets the integer attribute whose name is <b>xx</b> and pushes it onto the stack. If the attribute is a string instead of an integer, the string is assumed to be an ASCII integer. It is converted to a binary integer using the <code>atoi</code> subroutine and pushed onto the stack.</p>
<b>%'c'</b>	<p>Pushes character constant <b>c</b> onto the stack, where it becomes the low-order byte of an integer value. The high-order bytes are set to 0 (zero).</p>
<b>%{nn}</b>	<p>Pushes integer constant <b>nn</b> onto the stack. The constant is a decimal value and can be either positive or negative.</p>

## Internal Variables:

Internal variables **a** through **z** are integer variables for use by **%P**, **%Z**, and **%g**. They are initialized to zero and their values change only if a **%P** or **%Z** changes them. There are two independent sets of these variables: one set is used by the `pio` command for building pipelines, while the other set is used exclusively by a formatter. The values for a formatter's set are maintained for the duration of the formatter's processing.

### Internal Variables:

---

Item	Descriptor
<b>%P[a-z]</b>	<p>Pops an integer value from the stack and stores it in the specified internal variable. For example, <b>%Pf</b> moves an integer value from the stack to variable <b>f</b>.</p>
<b>%Z[a-z]</b>	<p>Zeroes the specified internal variable. For example, <b>%Zg</b> stores a value of 0 in variable <b>g</b>.</p>

Internal Variables:

(continued)

---

Item	Descriptor
<b>%g[a-z]</b>	Pushes the value of the specified internal variable onto the stack. The value of the internal variable is not changed. For example, <b>%gb</b> reads the integer value in variable <b>b</b> and pushes it onto the stack.

Arithmetic Operators

Arithmetic Operators:

---

Item	Descriptor
<b>%+ %- %* %/ %m</b>	Pushes the result onto the stack.
<b>%+</b>	Adds the first two values popped off the stack. For example, <b>{5}{6}+</b> pushes a value of 11 onto the stack.
<b>%-</b>	Subtracts the first value popped off the stack from the second value popped off the stack. For example, <b>{12}{3}-</b> pushes a value of 9 onto the stack.
<b>%*</b>	Multiplies the first two values popped off the stack. For example, <b>{2}{3}*</b> pushes a value of 6 onto the stack.
<b>%/</b>	Divides the first value popped off the stack into the second value popped off the stack. For example, <b>{6}{2}/</b> pushes a value of 3 onto the stack.
<b>%m</b>	(modulus) Similar to <b>%/</b> , except that the remainder, instead of the quotient, is pushed onto the stack. For example, <b>{17}{9}m</b> pushes a value of 8 onto the stack.

**Note:** The first value to be popped off the stack is the last one to be pushed onto the stack, and the second value to be popped off the stack is the one that was pushed onto the stack first.

Relational and Logical Operators:

Relational and Logical Operators:

---

Item	Descriptor
<b>%= %&gt; %&lt; %!</b>	Pushes a value of 1 if true, or 0 if false, onto the stack.
<b>%=</b>	Are the first two values that are popped off the stack equal? For example, <b>{2}{2}%=</b> pushes a value of 1 (true) onto the stack, and <b>{2}{3}%=</b> pushes a value of 0 (false) onto the stack.
<b>%&gt;</b>	Is the second value popped off the stack greater than the first value popped off the stack? For example, <b>{2}{3}&gt;</b> pushes a value of 0 (false) onto the stack.
<b>%&lt;</b>	Is the second value popped off the stack less than the first value popped off the stack? For example, <b>{2}{3}&lt;</b> pushes a value of 1 (true) onto the stack.
<b>%!</b>	Negate the value popped off the stack and push the result onto the stack: nonzero value to 0; 0 value to 1. For example, <b>{0}%! </b> pushes a value of 1 (true) onto the stack, <b>{1}%! </b> pushes a value of 0 (false) onto the stack, and <b>{2}%! </b> pushes a value of 0 (false) onto the stack.

**Note:** The first value to be popped off the stack is the last one to be pushed onto the stack, and the second value to be popped off the stack is the one that was pushed onto the stack first.

Bitwise Logical Operators:

Bitwise Logical Operators:

---

Item	Descriptor
<code>%&amp; %  %^ %~</code>	Pushes the result onto the stack.
<code>%&amp;</code>	ANDs the first two values popped off the stack. For example, <code>{6}{3}%&amp;</code> pushes a value of 2 onto the stack.
<code>% </code>	ORs the first two values popped off the stack. For example, <code>{6}{3}% </code> pushes a value of 7 onto the stack.
<code>%^</code>	EXCLUSIVE ORs the first two values popped off the stack. For example, <code>{6}{3}%^</code> pushes a value of 5 onto the stack.
<code>%~</code>	ONE'S COMPLEMENTS the first value popped off the stack and inverts the value of each bit. For example, <code>{-1}%~</code> pushes a value of 0 (all bits off) onto the stack (assumes two's complement notation for -1).

Conditional (if-then-else) Operators:

Conditional (if-then-else) Operators:

---

Item	Descriptor
<code>%? expr %t thenpart %e elsepart %;</code>	<code>%t</code> pops a value off the stack and tests it. If the value is <b>TRUE</b> (nonzero), <b>thenpart</b> is run. Otherwise, <b>elsepart</b> (if present) is run.

*else-if construct*

```
%? c1 %t b1 %e c2 %t b2 %e c3 %t b3 %e b4 %;
```

where **c1**, **c2**, **c3** denote conditions and **b1**, **b2**, **b3**, **b4** denote bodies. For example, `{1}%t{2}%e{3}%;` pushes a value of 2 onto the stack, and `%gx{6}%?%=%t{2}%e{3}%;%d` outputs a value of 2 if the value of the internal variable **x** is 6. If value of **x** is not 6, a value of 3 is output.

When developing complex logic, it is sometimes useful to show it in structured form. The preceding example, in structured form, might look like this:

Item	Descriptor
<code>%gx</code>	Pushes the value of <b>x</b> onto the stack
<code>{6}</code>	Pushes a value of 6 onto the stack
<code>%?%=%t</code>	If the stack values are equal then
<code>{2}</code>	pushes a value of 2 onto the stack
<code>%e</code>	else
<code>{3}</code>	pushes a value of 3 onto the stack
<code>%;</code>	endif
<code>%d</code>	Outputs the value in ASCII format

**Pass-through:**

Pass-through:

---

Item	Descriptor
<b>%x</b>	(This <code>piocmdout</code> subroutine call only. See the <code>piocmdout</code> subroutine for more information.) Pass through from input to output the number of bytes specified by the <b>passthru</b> argument to the <code>piocmdout</code> subroutine. See the <b>passthru</b> argument to the <code>piocmdout</code> subroutine for more information.

Loops

Loops:

---

Item	Descriptor
<b>%wx</b>	<b>While</b> loop. Whenever a matching <b>%;</b> is reached, the value of the internal variable <code>x</code> ( <code>x</code> can be <b>a</b> through <b>z</b> ) is decremented by one. If the result is greater than 0, execution is transferred to the character following <b>%wx</b> .

Mode:

Item	Descriptor
<b>%o</b>	Starts using only original default values from the database instead of values that may have been updated from the command line (or during formatter processing).
<b>%r</b>	Returns to using the values that were being used before <b>%o</b> .

Pipeline Overrides:

Item	Descriptor
<b>%p</b>	Indicates where to embed the prefix-filter pipeline in the main pipeline. If not present, it is assumed to be at the beginning of the main pipeline. Ignored if the first character of the attribute name is not <b>i</b> (that is it is not a main pipeline)
<b>%z</b>	Indicates where to embed the <b>pioout</b> string (device-driver interface routine) in the main pipeline. If not present, it is assumed to be at the end of the main pipeline. If the first character of the attribute name is not <b>i</b> (that is, it is not a main pipeline), it is ignored.
<b>%ix</b>	Can be specified only in a prefix filter string (that is, the first character of the attribute's two-character name is <b>f</b> ). The <b>x</b> variable represents a pipeline identifier character. The <b>%ix</b> variable specifies that the attribute name for the main pipeline should be <b>ix</b> instead of <b>iy</b> , where <b>y</b> is the parameter specified (or defaulted) for the <b>-d</b> flag. As a special case <b>%i!</b> specifies that a null string should be used as the main pipeline.

Command Line Flags:

These operators are usually used in pipeline definitions, where they apply to flags specified by the print job submitter. If specified in attribute strings used by a formatter, they apply to the flags passed to the formatter. Valid flag letters are **a** through **z**, **A** through **Z**, and **0** through **9**.

Item	Descriptor
<b>%Cy</b>	Pushes a value of 1 (true) onto the stack if flag <b>y</b> was specified on the command line. Otherwise, pushes a value of 0 (false) onto the stack.

<b>Item</b>	<b>Descriptor</b>
<b>%Fxy or %F[...]</b>	<p>Shorthand for <b>%%?%Cy%t-x %I_y%</b>. If the <b>y</b> flag was specified on the command line, generates <b>-x yarg</b>, where <b>yarg</b> is the argument specified for the <b>y</b> flag. If <b>!</b> is specified for <b>x</b>, <b>-x</b> will not be generated. If <b>yarg</b> contains an unprotected (not immediately preceded by an odd number of back slashes) single or double quotation mark, an error message is issued and the print job is terminated.</p> <p>If multiple flags are to be specified using <b>%Fxy</b>, and each flag's <b>x</b> and <b>y</b> values are identical, a list of flag letters can be specified in brackets. For example, <b>%Faa%Fbb%Fcc</b> can be specified as <b>%F[abc]</b>.</p> <p>The values referenced by <b>y</b> or <b>[...]</b> have attribute names whose first character is <b>_</b> (underscore) and whose second character is <b>y</b> or a character in the string <b>[...]</b>.</p>
<b>%fxy or %f[...]</b>	<p>Similar to <b>%Fxy</b> and <b>%F[...]</b>, except that no space is placed between the flag name and the argument, unless the argument is a null string.</p>
<b>%vxy or %v[...]</b>	<p>Similar to <b>%fxy</b> and <b>%f[...]</b>, but used only in the command string for the <b>pioout</b> command, the Device Driver Interface Program, to generate flags and arguments for override values specified by the <b>pio</b> command, the Print Job Manager. Flags are not generated when their arguments are equal to predefined default values.</p> <p>With <b>%v</b>, the values referenced by <b>y</b> or <b>[...]</b> have attribute names whose first character is <b>@</b> (at sign) and whose second character is <b>y</b> or a character in the string <b>[...]</b>.</p>
<b>%Ux or %U[...]</b>	<p>Indicates to the <b>pio</b> command that the <b>x</b> flag (or each flag in the string <b>[...]</b>) is actually referenced even though it is not referenced by a pipeline; for example, the <b>x</b> flag may be referenced by a printer command instead of by a filter in a pipeline. This prevents the <b>pio</b> command from rejecting the flag when specified on the command line.</p>

## Printer colon file conventions

---

Printer and printer data stream attributes reside in colon files.

Colon files reside in the `/usr/lib/lpd/pio/predef` and `/var/spool/lpd/pio/@local/custom/*` directories. The `/usr/lib/lpd/pio/predef` directory contains the predefined database and the `/var/spool/lpd/pio/@local/custom/*` directory contains the customized database.

The following sections describe the conventions for printer and attribute names and values in colon files.

### Colon file format

Colon files in both the predefined and customized databases have five fields (separated by colons) for each attribute.

The five fields for each attribute in a colon file are:

<b>Item</b>	<b>Descriptor</b>
<b>Message catalog ID</b>	<p>Identifies the message catalog where the attribute description is stored. The message catalog ID can take any of three forms:</p> <ul style="list-style-type: none"> <li>• Null string: The string value for the <b>mD</b> attribute is assumed to be the file name of the message catalog (for example, <code>mydescriptors.cat</code>).</li> <li>• One character: An abbreviation for <b>pioattr. x.cat</b>, where <i>x</i> is the one-character catalog ID. This form of the catalog ID is normally used only by the operating system.</li> <li>• Catalog file name: The file name of the message catalog (for example, <code>mydescriptors.cat</code>).</li> </ul> <p>Either the one-character form or the catalog file name form of the catalog overrides the catalog file name specified with the <b>mD</b> attribute.</p> <p><b>Message number</b> Identifies the message index in the catalog that contains the description of this attribute. Leading zeros are ignored.</p> <p><b>Attribute name</b> Specifies two characters, except for group header attributes, which are five characters.</p> <p><b>Limits field</b> Specifies limits for the attributes.</p> <p><b>Attribute value string</b> Specifies zero to 1000 characters.</p>

The following is an example of one line in a colon file:

```
:023:_w: :80
```

The attribute name is **\_w**, the attribute value string is **80**, and the attribute description is stored in message number **23** in the message catalog specified by the **mD** attribute.

**Note:** All attribute descriptions are stored in message catalogs. If an attribute has the same description for multiple printers, the attribute in each printer's database can reference the same catalog and message number. If the same attribute name has a different description for different printers, separate message numbers are used.

## Virtual printer attribute names

Established conventions for virtual printer attribute names are described.

The following conventions have been established for virtual printer attribute names:

- Each attribute name must be unique.
- Attribute names can contain the characters **a** through **z**, **A** through **Z**, **0** through **9**, and **\_** (underscore). The name cannot begin with a numeral.
- All attribute names must be two characters long (except group header attribute names, which can be five characters long).
- Attribute names for group headers begin with **\_\_** (two underscores) and must not be longer than five characters. A *group header attribute* (formerly called a comment attribute) marks the beginning of a group of related attributes. For example, the group header attribute **\_\_FLG** marks the beginning of a group of attributes that define the default values for command line flags. The grouping of attributes is for readability purposes and does not affect how the attributes are processed.
- An attribute name beginning with **\_** (an underscore), except for group headers, can be overridden by a command line flag of the same name as the second character of the attribute name. For example, `-w`

132, specified with the **qpri** command, overrides with a value of **132** the value specified for the **\_w** attribute in the colon file.

## Virtual printer automatic attributes

*Automatic* attributes are names and values that are provided automatically and that cannot be in the database.

Virtual printer automatic attributes

---

### Ite

#### m Descriptor

- @0** Always a null string. This attribute name can be used wherever an attribute name for a null string is needed.
- @1** A string containing the full path name of the file being printed. This attribute name is available only to attributes that define pipelines and attributes included by pipelines. The file being printed will be a temporary file if the **-c** flag is specified with the **qpri** command.
- @2** An integer containing the number of bytes to be passed through when **%x** is found in a command string by the `piocmdout` subroutine (obtained from the **passthru** parameter passed to the `piocmdout` subroutine).
- @3** An integer value indicating how the printer is attached:
  - 0** Neither parallel nor serial
  - 1** parallel
  - 2** serial
- @4** The full path name of the `pio` directory whose subdirectories (`burst`, `etc`, `fmtrs`, `fonts`, `predef`, `trans1`, and `trans2`) contain STATIC data files and utility programs used to configure virtual printers and process print jobs. The directory must be a subdirectory of the directory containing the **pio** command invoked by the **qdaemon**. The value for **@4** is normally the `/usr/lib/lpd/pio` directory.
- @5** The full path name of the `pio` directory whose subdirectories (`custom`, `ddi`, `dev`, and `flags`) contain DYNAMIC data files used to configure virtual printers and process print jobs. The value for **@5** is normally the `/var/spool/lpd/pio` directory.

The following attribute names are used for communicating from the **pio** command (the print job manager) to the **pioout** command (the device driver interface program). The attribute values are referenced by flag arguments passed to the device driver interface program as specified in the pipelines.

### Ite

#### m Descriptor

- @A** Number of bytes already printed.
- @B** Total number of bytes to print.
- @C** Number of times to send the cancel string (**@D**) to the printer at print job cancel.
- @D** String to send to the printer if the print job is canceled.
- @I** User to which to send intervention required messages.
- @O** Name of file to be generated by the **pioout** command in which to store data instead of sending it to the printer.

**Item Descriptor**

**@P** Name of file (usually the header page) to be sent to the printer before the first byte of the print file is sent.

**@S** Name of file to be sent to the printer after the last byte of the print file has been sent.

## Virtual printer reserved attribute names

*Reserved* attribute names are names that are assumed by the print job manager.

Virtual printer reserved attributes

---

Item	Descriptor
<b>First two characters are _ _</b>	Group header attribute.
<b>First character is @</b>	Value is provided automatically.
<b>First character is _</b>	Default value for flag argument.
<b>First character is i</b>	Pipeline for input data stream.
<b>First character is l</b>	Flags prohibited for input data stream.
<b>First character is f</b>	Command string for the filter flag.

### First character is z and second character is D, P, or S:

**Item Descriptor**

**zD** Default state of the colon file when in the `/var/spool/lpd/pio/custom/*` directory (+ means expanded, ! means contracted).

**zP** Name of the colon file's parent colon file. The parent colon file is assumed to be in the `/usr/lib/lpd/pio/predef/*` directory.

**zS** Current state of the colon file (+ means expanded, ! means contracted).

Item	Descriptor
<b>First character is y</b>	Values for terminal-attached printers.

## Virtual printer suggested attribute names

*Suggested* attribute names are names that are assumed by many formatter filters.

Virtual printer suggested attributes

---

Item	Descriptor
<b>First character is s</b>	System administrator value.
<b>First character is d</b>	Directory path.
<b>First character is m</b>	Miscellaneous value (constant).
<b>First character is w</b>	Work value (changes while formatting).
<b>First character is c</b>	Command aggregate.
<b>First character is a</b>	ASCII control code.
<b>First character is e</b>	Printer escape sequence.

Virtual printer suggested attributes

(continued)

---

Item	Descriptor
<b>First character is t and second character is 0-9</b>	Full path names of zero or more. Stage 2 translation tables used by formatter. Multiple values must be separated by commas.

## Attribute values

Conventions have been established for attribute values.

The following conventions have been established for attribute values:

- Printer names are of the form **4201-3**, reflecting the printer name (**4201**) and model number (**3**).
- File names in the Predefined Database are of the form *PrinterType.DataStreamType*; for example, `4216-31.asc` indicates a 4216 Model 31 printer and an ASCII data stream.
- File names in the Customized Database are of the form `QueueName:QueueDeviceName`, such as `pioq:mypio`.
- Attribute values can contain a \ (backslash) followed by one to three octal digits to represent non-ASCII values. A \ (backslash) that does not begin an octal sequence should be represented by either `\\` or `\134`.
- Characters can be represented by hexadecimal notation of the form `\xXX`, where **XX** represents a hexadecimal value.
- Boolean values can be represented by a + (plus sign) for true, and an ! (exclamation point) for false.
- Because attribute values reside in colon files, a colon character must not appear in the attribute value. Instead, a colon should be represented by `\072`.
- An attribute value that references an integer attribute requiring translation from a lookup table should always appear in a colon file after the referenced integer attribute: For example, from the string **red** to an equivalent integer value of 2. Integer values are created from a colon file in the same order they are defined in the colon file. Listing the attribute value first ensures that when the integer attribute is referenced, it has been converted before it is referenced by the **%G** escape sequence.
- Run all the shell commands using **ksh** instead of **bsh**.

## Colon file limits field

The limits field in the colon file contains SMIT dialog information and validation information.

The limits field in the colon file contains two types of information, SMIT dialog information and validation information.

### SMIT dialog information

Information used in building SMIT objects represent colon file attributes in the object data manager (ODM). These objects will be used in the Print a File, Printer Setup, and Default Job Characteristics dialogs.

The limits field gives you some control over the type of `sm_cmd_opt` ODM object that is built for every object. You can control whether or not an attribute is always displayed, never displayed, or displayed only if it is referenced in a pipeline. You can modify the following fields:

- `id_seq_num`
- `entry_type`
- `cmd_to_list_mode`
- `required`
- `op_type`

- multi\_select
- disp\_values
- aix\_values
- values\_msg\_file
- values\_msg\_set
- values\_msg\_id
- help\_msg\_id
- help\_msg\_loc

### Validation information

Validation information validates attribute values when the colon file is complete and a print job is submitted.

## Print formatter example

This example shows how print formatters can interact with the documented printer formatter subroutines.

The procedure for writing a print formatter involves four steps:

1. Creating a print formatter source file as shown below
2. Creating an imports file
3. Creating an exports file
4. Compiling and linking the print formatter

### Print formatter source file

Use an ASCII editor to create a formatter source file named `sample.c`. The file should contain the following lines:

```
#include <stdio.h>
#include <piostruct.h>

/* STRING CONSTANTS */
/* Initialize Printer, Restore Printer, Form Feed */
#define INIT_CMD    "ci"
#define REST_CMD    "cr"
#define FF_CMD      "af"

/* INTEGER and STRING VARIABLES */
/* page length, page width, top margin, bottom margin */
#define Pglen      (*( _Pglen + piomode))
#define Pgwidth   (*( _Pgwidth + piomode))
#define Tmarg     (*( _Tmarg + piomode))
#define Bmarg     (*( _Bmarg + piomode))

/* indentation, begin page, form feed?, pass-through? */
#define Indent     (*( _Indent + piomode))
#define Beginpg   (*( _Beginpg + piomode))
#define Do_formfeed (*( _Do_formfeed + piomode))
#define Passthru  (*( _Passthru + piomode))

/* initialize printer?, restore printer? */
#define Init_printer (*( _Init_printer + piomode))
#define Restoreprinter (*( _Restoreprinter + piomode))

/* Command names: form feed, vertical increment and decrement */
#define Ff_cmd     (*( _Ff_cmd + piomode))
#define Vincrl_cmd (*( _Vincrl_cmd + piomode))
#define Vdecr_cmd  (*( _Vdecr_cmd + piomode))
```

```

/* Work variables for vertical increment and decrement */
#define Vincr      (*(_Vincrcr + piomode))
#define Vdecr     (*(_Vdeccr + piomode))

/* Variables referenced by above #defines */
int *_Pglen, *_Pgwidth, *_Tmarg, *_Bmarg, *_Indent, *_Beginpg, *_Do_
formfeed, *_Passthru, *_Init_printer, *_Restoreprinter, *_Vincrcr, *_V
deccr;
struct str_info *_Ff_cmd, *_Vincrcr_cmd, *_Vdeccr_cmd;

/* TABLE OF ATTRIBUTE VALUES */
struct attrparms attrtable[] = { /*
name data type lookup address of pointer */
"_b", VAR_INT, NULL, (union dtypes *) &_Bmarg,
"_g", VAR_INT, NULL, (union dtypes *) &_Beginpg,
"_i", VAR_INT, NULL, (union dtypes *) &_Indent,
"_j", VAR_INT, NULL, (union dtypes *) &_Init_printer,
"_l", VAR_INT, NULL, (union dtypes *) &_Pglen,
"_t", VAR_INT, NULL, (union dtypes *) &_Tmarg,
"_w", VAR_INT, NULL, (union dtypes *) &_Pgwidth,
"_J", VAR_INT, NULL, (union dtypes *) &_Restoreprinter,
"_Z", VAR_INT, NULL, (union dtypes *) &_Do_formfeed,
"wp", VAR_INT, NULL, (union dtypes *) &_Passthru,
"wf", VAR_STR, NULL, (union dtypes *) &_Ff_cmd,
"wi", VAR_STR, NULL, (union dtypes *) &_Vincrcr_cmd,
"wy", VAR_STR, NULL, (union dtypes *) &_Vdeccr_cmd,
"wV", VAR_INT, NULL, (union dtypes *) &_Vincrcr,
"wD", VAR_INT, NULL, (union dtypes *) &_Vdeccr,
NULL, 0, NULL, NULL };
int pglenc, tmarg, bmarg, vpos, vtab_base;
struct shar_vars sharevars;

struct shar_vars * /*** Setup Processing ***/
setup(argc, argv, passthru)
    unsigned argc;
    char *argv[];
    int passthru;
{

/* Initialize variables and command line values */
(void) piogetvals(attrtable, NULL);
(void) piogetopt(argc, argv, NULL, NULL);
/* (need to verify values entered by user) */

/* Initialize work variables */
pglenc = Pglen * Vincrcr;
tmarg = Tmarg * Vincrcr;
bmarg = Bmarg * Vincrcr;
piopgskip = Beginpg - 1;

/* Check for pass-through option */
if (Passthru = passthru)
    return(NULL);

/* Initialize pointers to vertical spacing */
/* variables shared with formatter driver */
/* (Refer to /usr/include/piestruct.h) */
sharevars._pl = &pglenc;
sharevars._tmarg = &tmarg;
sharevars._bmarg = &bmarg;
sharevars._vpos = &vpos;
sharevars._vtab_base = &vtab_base;
sharevars._vincrcr = &Vincrcr;
sharevars._vincrcr_cmd = (&Vincrcr_cmd)->ptr;
sharevars._vdeccr = &Vdeccr;
sharevars._vdeccr_cmd = (&Vdeccr_cmd)->ptr;
sharevars._ff_cmd = (&Ff_cmd)->ptr;
sharevars._ff_at_eof = &Do_formfeed;
return(&sharevars);
}

initialize() /*** Initialize the Printer ***/
{

```

```

if (Init_printer)
    (void) piocmdout(INIT_CMD, NULL, 0, NULL);
return(0);
}

```

```

lineout(fileptr) /*** Format a Line ***/
FILE *fileptr;
{
int ch, charcount = 0;
for (ch = 0; ch < Indent; ch++)
    pioputchar(' ');
while ((ch=piogetc(fileptr)) != '\n' && ch != EOF
    && charcount < Pgwidth) {
    charcount++;
    pioputchar(c);
}
vpos += Vinc1;
return(charcount);
}

```

```

passthru() /*** Pass-through Option ***/
{
int ch;
while ((ch = piogetc(stdin)) != EOF)
    pioputchar(ch);
if (piodatasent && Do_formfeed)
    (void) piocmdout(FF_CMD, NULL, 0, NULL);
return(0);
}

```

```

restore() /*** Restore the Printer ***/
{
if (Restoreprinter)
    (void) piocmdout(REST_CMD, NULL, 0, NULL);
return(0);
}

```

### Print formatter compiling and linking

Use an editor to create an imports file named `sample.imp`. The file should contain the following:

```

#!
main
piogetvals
piogetopt
piomsgout
pioexit
piomode
piodatasent
piopgskip
statusfile
piocmdout
piogetstr

```

Use an editor to create an exports file named `sample.exp`. The file should contain the following:

```

#!
setup
initialize
passthru
restore
lineout

```

Enter the following to compile and link the formatter:

```

cc -o sample -BI:sample.imp -BE:sample.exp sample.c

```

## Backend and qdaemon interaction

---

The **qdaemon** and the backend communicate through a status file.

The **qdaemon** and the backend communicate through a status file. “Back-end routines in libqb” on page 83 explains the set of library routines that the backend should use to fulfill these communication requirements. These routines are in the `/usr/lib/libqb.a` library.

### Status file

Each queue and its associated queue has a status file.

When the **qdaemon** process invokes a backend (see the **qdaemon** for more information), it passes the following parameters, in order:

1. The parameters appearing in the `/etc/qconfig` file. See the `/etc/qconfig` file for more information.
2. The flags that the **enq** command (see the **enq** for more information) did not recognize, in the order they were given. These flags will be preceded by the `-o` option on the command line.
3. The names of one or more files to be printed.

There is a status file for each device and its associated queue. These files are found in the `/var/spool/lpd/stat` directory.

The status file provides a means of communication for the **qdaemon** process and the backend. The **qdaemon** passes information such as the date of the file, whether to print burst pages, and the number of copies to be printed. The backend passes back the charge for the job it has just finished running. In addition, the backend periodically updates the number of pages it has printed and what percent of the job is finished. This information is read by the **qchk** command. See the **qchk** for more information.

**Note:** Backends should never explicitly write into their status file. They should call the **libqb** library routines to do this.

The routines are called for the following reasons:

- The backend is spared the trouble of accessing the status file directly.
- The format of the status file can be changed without requiring backends to be rewritten. Should the format of the status file change, the backend only needs to be re-linked.

To initialize certain data common to the library routines, the backend must call the routine **log\_init**. For more information see “Back-end routines in libqb” on page 83. The call is as follows:

```
log_init();
```

This routine should be called to initialize the status file interface. The **log\_init** routine, like all **log\_** routines in the library, returns a value of `-1` if it fails.

### Multiple copy printing

You can print multiple copies of a file with the **enq -N** command.

The **enq -N** command prints extra copies of a file. For example, to print five copies of a file `filename`, enter this command:

```
enq -N5 filename
```

The **enq** command passes the information to the **qdaemon** process, which puts it into the status file. Backends should get the information by calling the `get_copies` routine, which returns the total number of copies requested. See “Back-end routines in libqb” on page 83 for more information.

## Job status information

You can use the `qchk` command to display information about print jobs that are currently running.

The `qchk` command displays information about currently running jobs, including the originator, title, number of pages to be printed, and percentage completed. All this information comes from the status file. Most of the information is set up by the `qdaemon` when the backend is first invoked, except the **pages printed** and **percent done** fields, which must be filled in by the backend itself.

To provide this information, the backend should periodically call `libqb` (see [“Back-end routines in libqb” on page 83](#)) for the following functions:

- `log_progress(pages,percent)`
- `log_pages(pages)`, for individual function
- `log_percent(percent)`, for individual function

The backend can call these routines at any time; once at the end of each page is recommended.

## Print job charges

When a backend completes a job, the `qdaemon` reads the status file for a charge.

If the `qconfig` file has been set up to do so, the charge is written to a file that is eventually processed by the accounting programs. This results in a bill (real or imaginary) for the user issuing the print request.

The backend passes the charge back to the `qdaemon` with the routine `log_charge(charge)`. (see [“Back-end routines in libqb” on page 83](#)). The backend should call this routine on exit. It should also call the routine along with `log_progress` while printing the job. For more information, see [“Job status information” on page 80](#). Otherwise, if the job is canceled, no charge will be made for the pages printed up to that point.

The charge is interpreted by all current accounting programs as the number of pages printed. However, a backend can set the charge to be based on any multiplier, whole or fraction, of pages printed.

For more information about job accounting, see [“Print spooler” on page 44](#).

## Exit codes

When a backend exits, the exit code is examined by `qdaemon` for information such as whether the job completed successfully and whether the device is still usable.

When a backend exits, the `qdaemon` looks at its exit code for such information as whether the job was completed successfully and whether the device is still usable. Therefore, it is important that backends use the same convention for their exit codes. The backend should use `#include <IN/standard.h>` for the values of the codes given here.

The permissible exit codes are:

Item	Descriptor
<b>EXITOK</b>	No problems encountered.
<b>EXITBAD</b>	The parameters could not be acted upon. Two common examples are a flag's not being valid or a file that could not be opened. The <code>qdaemon</code> sets the state of the device (displayed by <code>qchk</code> ) to OFF, sends a message to the console, and does not run any further jobs on that device until someone has explicitly set its state to ON again (with an <code>enq -PqueueName -U</code> command).
<b>EXITERROR</b>	The backend could not finish printing the job. The <code>qdaemon</code> restarts the same job from the beginning on the same device. The <code>qdaemon</code> enforces a limit on the number of times the job will be restarted.

Item	Descriptor
<b>EXITFATAL</b>	The job could not be finished because of a problem in the device that requires manual intervention. The <b>qdaemon</b> sets the state of the device (displayed by <b>qchk</b> ) to OFF, sends a message to the console, and does not run any further jobs on that device until someone has explicitly set its state to ON again (with an <b>enq -PqueueName -U</b> command).
<b>EXIT SIGNAL</b>	The backend was interrupted by a <b>SIGTERM</b> signal ( <b>#include &lt;signal.h&gt;</b> ).
<b>EXITWARN</b>	The backend has issued a warning to the <b>qdaemon</b> . The job may or may not be completed successfully, but in either case, when the <b>qdaemon</b> receives an <b>EXITWARN</b> from the backend, <b>qdaemon</b> returns a message explaining the problem.

## Returned error messages

When an error event occurs, the backend should send a message to the user.

Before sending a message, the backend should check the **PIO\_IPCWRITEFD** environment variable. If it is set, the message is sent to a print supervisor by way of a pipe. The print supervisor interprets the message and sends it to the user. If the **PIO\_IPCWRITEFD** environment variable is not set, the backend sends the message to the user with the `sysnot` routine.

The **qdaemon** print spooler always uses the `sysnot` (“Back-end routines in libqb” on page 83) routine to send messages. Non-base operating system print spoolers can use the `sysnot` routine or the pipe to send messages.

### sysnot routine

The backend can send messages directly to the user with the `sysnot` routine.

The `sysnot` routine can either mail the message to the user or write the message to the user's terminal. The `sysnot` routine is called with the following syntax:

```
sysnot(user, host, message, pref)
char *user;
char *host;
char *message;
unsigned int *pref;
```

The value of the `pref` parameter should be `DOMAIL` or `DOWRITE`. `DOMAIL` mails the error message to the user. `DOWRITE` writes the message to the user's terminal if the user is logged on. If the user is not logged on, the message is mailed to the user. The `DOMAIL` and `DOWRITE` constants are defined in the `/usr/include/IN/backend.h` file.

See “Back-end routines in libqb” on page 83 for more information.

## Pipes

The backend can send messages to the user by sending the message to a print supervisor by way of a pipe. This mechanism provides a one-way communication path between the printer backend and the print supervisor.

The print supervisor must open an unnamed pipe and obtain two file descriptors, one for read operations and one for write operations. The print supervisor must export the write end in the **PIO\_IPCWRITEFD** environment variable before calling the printer backend with the `fork` and `exec` subroutines. If the **PIO\_IPCWRITEFD** environment variable is set, the printer backend writes any messages to the write end of the pipe.

The print supervisor typically calls the `select` subroutine to poll the read side of the pipe for incoming messages. In addition to checking for exit status of the printer backend using the `waitpid` subroutine, the print supervisor polls for I/O on the pipe. The print supervisor sets up a signal handler for the **SIGCHLD** signal and performs a block read on the pipe. The signal handler examines the exit status of the printer

backend and performs any action necessary. When no unread messages remain on the pipe, the print supervisor closes the pipe and proceeds to other cleanup work.

## Message Format

Each message sent by the printer backend consists of a message header frame, zero or more parameter header frames, a fully expanded message, and text consisting of zero or more parameters.

The message header specifies the message type, message catalog information, length of expanded message text, and the number of variable message parameters. The variable message parameters are used to build the expanded message text from the basic message text that is extracted from the message catalog. The structure formats for the message header and the message parameter header frames are defined in the `/usr/include/piostruct.h` file.

When extracting messages from the pipe, the print supervisor reads the message header frame, then reads the message parameter header frames (0-9, as specified by the number of parameters specified in the message header frame). The print supervisor reads the expanded message text, the length of which is specified in the message header frame, followed by the parameters (if any). The type and length of any parameters are specified in the individual message parameter header frames.

The type of message is specified in the message header frame. The message types are as follows:

- **ID\_VAL\_EVENT\_ABORTED\_BY\_SERVER**
- **ID\_VAL\_EVENT\_WARNING\_RESOURCE\_NEEDS\_ATTENTION**

The actual message text is in expanded format. The parameters are placed in the message text after the parameters are extracted from the message catalog file in the server's locale. The print supervisor can use the message text or build its own message text from the supplied message catalog information and the message parameters. However, the printer backend cannot provide message catalog information (message number, set number, and catalog name) and variable message parameters in all cases. Therefore, the print supervisor must check for the catalog name field (**pm\_catnm** field) to determine if the catalog name is a null string. If the catalog name is a null string, the print supervisor must use the supplied expanded message text.

If a catalog name is provided, the print supervisor can extract the message from the catalog and place any supplied message parameters in the message. The message parameters can be integer or string type. However, message parameters are passed from the printer backend as strings concatenated to the expanded message text. If the print supervisor extracts the message from the specified catalog and places the parameters in the message, the following conventions apply:

- Parameters can be integer or string type, but are always passed in the pipe as strings with a trailing **NUL** character. The length of each parameter in string format is supplied in the parameter's associated header frame.
- Extracted messages can contain escape sequences recognized by the `printf` subroutine. Therefore, while populating the message, the print supervisor checks for escape sequences such as **%s**, **%d**, and **%c**, and converts the parameters accordingly. Positional parameters are sometimes specified by using **%n\$s** or **%n\$d**. In such cases, the print supervisor fills in the parameters in the specified order.
- A maximum of nine parameters can be specified. Therefore, the print supervisor can use nine variables of `*char` type and assign the variables to the appropriate supplied parameter strings. After replacing all positional specifiers and integer specifiers, the parameters can be passed to the `printf` subroutine. For example, the extracted message text might contain the following:

```
Error %8$d in opening %6$s file
```

The print supervisor converts the message to the following:

```
Error %s in opening %s file
```

The print supervisor assigns the first variable parameter pointer to the eighth parameter, the second variable parameter pointer to the sixth parameter, and the remaining variable parameter pointers to null

strings. The print supervisor then calls the `sprintf` subroutine or a similar subroutine and passes the nine variable parameter pointers as parameters to the function.

- The printer backend specifies the correct type (integer or string) for each parameter, even though all parameters are passed in the pipe as strings. The appropriate type must be used for handling field width and precision when placing a parameter in an extracted message.
- The printer backend may or may not pass message catalog information and parameters for a message. Therefore, the print supervisor must be able to accept the expanded message itself, or accept the catalog information and parameters and then build the message accordingly.

## Queue states

The **qchk** command displays the status of a particular device.

One of the entries in the table that is displayed shows the current state of the queue. This information is taken from the status file. See `/usr/include/IN/backend.h` in your status file for a list of valid queue states and their explanation.

Normally, the **qdaemon** keeps the status file updated. However, some backends may want to set explicitly the state to `WAITING` (**#include <IN/backend.h>**) if they can no longer send output to the device, and set it back to `RUNNING` when output resumes. For example, a backend that paused at the end of each page, waiting for user response, might want to set the status to `WAITING` during this time.

The `log_status(status)` routine can be used to change the status of the job from `RUNNING` to `WAITING` and back again. For more information, see [“Back-end routines in libqb” on page 83](#). The parameter is the new status.

In the case of a **DEV\_WAIT** state on a queue device, issue `enq -U -Pqueue` to attempt to get the queue to a state of readiness. If this does not work move all the jobs in that queue and issue `enq -G` in order to flush the other queues and bring down the **qdaemon**. Then restart the **qdaemon**.

## Termination on receipt of SIGTERM

When a user cancels a running job with **qcan**, the command passes the request to the **qdaemon**.

The backend must stop the print soon after receiving the signal. There are two ways to accomplish this.

First, the backend cannot do anything special about `SIGTERM`, in which case the signal stops the backend process immediately. This option is the simplest, but it does not allow the backend to do any cleanup (reset line speeds, put paper at top-of-form, hang up the phone) before it terminates.

Second, the backend can catch `SIGTERM`, carry out whatever cleanup tasks are required, and exit `EXIT_SIGNAL` (**#include <IN/standard.h>**). The special exit code tells the **qdaemon** that the job was canceled.

Backends that decide to catch `SIGTERM` should exit very soon after receipt of the signal.

See the **qcan** command and the **qdaemon** command for more information.

## Back-end routines in libqb

---

The back-end uses a set of library routines to communicate with the **qdaemon** process.

This topic defines the set of library routines that the back-end uses to communicate with the **qdaemon** process. These routines are in the `/usr/lib/libqb.a` library; they were designed to make the task of writing a back-end routine as easy as possible. These back-end routines are available by using the **ld** or **cc** command-line option `-lqb`.

For information about using these routines with the back-end, see [“Backend and qdaemon interaction” on page 79](#).

Item	Descriptor
<code>get_align()</code>	Returns <b>TRUE</b> or <b>FALSE</b> , telling whether an alignment form-feed is to be printed. A form-feed is printed only when the printer has been idle and is about to print a new job. The form-feed aligns the paper to top-of-form and is helpful if someone moved the paper while the printer was idle.
<code>get_cmd_line()</code>	Returns a pointer to an array of characters containing the <b>enq</b> command-line as invoked by the user. The string returned does not contain the name <code>/usr/bin/enq</code> , any of the file names specified, or any options that were sent to the back-end routine by using the <b>enq -o</b> option. For example, if the user enters the command-line <code>enq -Plp0 -Bgn -o -i15 filename</code> , the <code>get_cmd_line</code> function returns the string <b>-Plp0 -Bgn</b> . This function is useful when the back-end routine needs to know the command-line options a user provided when the job was submitted.
<code>get_copies()</code>	Returns the number of copies to be printed. Its return value is of type <b>int</b> .
<code>get_device_name()</code>	Returns a pointer to an array of characters containing the device name.
<code>get_feed()</code>	Returns the number of feed pages to be printed. Its return value is of type unsigned int. Feed pages are blank pages printed only when the printer has become idle. This makes it easier to tear off paper from the printer.
<code>get_from()</code>	Returns an array of characters containing the name of the person who made the print request. The return value is of type <b>char*</b> .
<code>get_header()</code>	Returns <b>NEVER</b> , <b>ALWAYS</b> , or <b>GROUP</b> ( <b>#include &lt;IN/backend.h&gt;</b> ). Its return value is of type unsigned int. A header is a page preceding a file that shows its title, date, its recipient, and other information.
<code>get_job_number()</code>	Returns job number of current print. Its return value is of type <b>int</b> .
<code>get_mail_only()</code>	Returns <b>TRUE</b> if the user specifies mail-only.
<code>get_qdate()</code>	Returns a string showing the date that the request was queued. The return value is of type <b>char*</b> .
<code>get_queue_name()</code>	Returns an array of characters containing the queue name.
<code>get_title()</code>	Returns an array of characters containing the title of the job being printed. The return value is of type <b>char*</b> .
<code>get_trailer()</code>	Returns <b>NEVER</b> , <b>ALWAYS</b> , or <b>GROUP</b> . Its return value is of type unsigned int. A trailer is a page following a file that gives the name of the user of the output.
<code>get_to()</code>	Returns an array of characters containing the name of the person for whom the job is intended. The return value is of type <b>char*</b> .
<code>get_was_idle()</code>	Returns <b>TRUE</b> if the printer was idle at job beginning (useful for paper feed: feed/no feed). Returns the charge for printing the current job.
<code>log_charge(charge) int charge;</code>	Returns the charge for printing the current job.
<code>log_init</code>	Initializes certain data common to the library routines.
<code>log_pages(pages)</code>	Updates the status file with the number of pages printed.
<code>log_percent(percent)</code>	Updates the status file with the percent of job completed.
<code>log_progress(log_pages(int), log_percent(char))</code>	Updates the status file with the number of pages printed and percent of job completed. This function uses <code>log_pages</code> and <code>log_percent</code> .
<code>log_status(status)</code>	Changes the status of the job from <b>RUNNING</b> to <b>WAITING</b> and back again. The parameter is the new status.
<code>put_header(fnaddr,width)</code>	Prints a header page with no following form-feed and returns the number of lines printed. The <code>fnaddr</code> and <code>width</code> parameters are optional. <b>int (*fnaddr);</b> The <code>fnaddr</code> parameter defines the format subroutine used to display characters on the header page. The default is the <code>putchar</code> subroutine. <b>int *width;</b> The <code>width</code> parameter defines the width of the form. The default value for the <code>width</code> parameter is <b>80</b> .

Item	Descriptor
<code>put_trailer(user,fnaddr,width)</code>	<p>Prints a trailer page for <i>user</i> with no following form-feed and returns the number of lines printed. The <i>fnaddr</i> and <i>width</i> parameters are optional.</p> <p><b>char *user;</b></p> <p><b>int (*fnaddr);</b> The <i>fnaddr</i> parameter defines the format subroutine used to display characters on the header page. The default is the <code>putchar</code> subroutine.</p> <p><b>int *width</b> The <i>width</i> parameter defines the width of the form. The default value for the <i>width</i> parameter is <b>80</b>.</p>
<code>sysnot(user,host,message,pref)</code>	<p>Sends a <i>message</i> to the <i>user</i> if the backend cannot run a job.</p> <p><b>char *user;</b></p> <p><b>char *host;</b></p> <p><b>char *message;</b></p> <p><b>unsigned int *pref;</b> The value of the <i>pref</i> parameter indicates whether to mail the message to the user or to write the message on the user's terminal. The valid values defined in the <code>/usr/include/IN/backend.h</code> file are:</p> <p><b>DOMAIL</b> Mails the error message to the user.</p> <p><b>DOWRITE</b> Writes the message to the user's terminal if the user is logged on. If the user is not logged on, the message is mailed to the user.</p>

## Printer code page translation tables

Translation of code points in the print file to code points for the printer is a two-stage process (translation of code points for Oriental languages is handled differently)..

The first stage translates code points from the print file to code points in an intermediate code page. The intermediate code page consists of 16-bit integer code points for all supported characters. The intermediate code page is defined in the `/usr/lib/lpd/pio/etc/codepage.txt` file.

## Printer code page translation for multibyte code sets

Multibyte code set (MBCS) translation from the print file to the code set differs from translation for single-byte code set (SBCS) code points.

Translation from print file to code set in multibyte environments is a two-stage process.

During the first stage of code-set translation, the input code set of the print file is translated to a process code set. The process code set must be one of the MBCS code sets supported by the `iconv` subroutine and locale database (DB). Examples include the IBM-943, IBM-eucTW, and IBM-eucKR code sets. During the second stage, the process code set is translated to an appropriate output code set for the printer. The `iconv` subroutine translates the code set, if the `iconv` converter for the translation exists. When the input or output code set and process code are the same, no code-set translation is performed.

The **Ti** and **To** attributes in the printer-dependent colon files define the possible flow of the translating code set. The **Ti** attribute specifies the combination of the input and process code sets:

```
[Input_code_set, ... ]Process_code_set, ...
```

The **To** attribute specifies the combination of the process and output code:

```
Process_code_set [Output_code_set0, Output_code_set1,  
Output_code_set2, Output_code_set3,... ], ...
```

For example, the **To** attribute for a Japanese printer is defined as:

```
::To::IBM-943[IBM-932, IBM-932, IBM-932], ibm-eucJP[IBM-932,  
IBM-932, IBM-932,IBM-932]
```

All characters of the character set ID (CSID) are printed using ROM fonts when an output code set is specified for each CSID. Otherwise, bitmap images from the Xwindows font are used. The type

of Xwindows font files, including the font image of each CSID, is selected by reading a file from the /usr/lib/X11/nls directory.

## Stage one printer code page translation

An intermediate code page is produced during the first stage of code page translation.

The example below generates a stage-1 translation table to translate code points from a hypothetical Code Page 123 to the intermediate code page.

```
#include <piostruct.h>
#include <fcntl.h>
/** Table to Translate Code Points for Input Code Page ***/
/** "123" to Code Points for the Intermediate Code Page ***/
short table[256] = {
/* 00 (000) */ CP, CP, CP, CP,
.
.
/* FC (252) */ CP, SC, 126, CP };
/** Write the Table to a File (Error Processing Not Shown) ***/
main ( ) {
int fildes;
int fmt_type = 1;
fildes = open("/usr/lib/lpd/pio/trans1/123", O_CREAT | O_WRONLY,\
0664);
write(fildes, "PIOSTAGE1XLATE00", 16);
write(fildes, &fmt_type, sizeof(fmt_type));
write(fildes, table, sizeof(table));
return(0);
}
```

The CP at code point 252 means that the code point should be copied with no change. The SC at code point 253 means the character is not defined in the intermediate code page and so a substitute character should be printed instead. The 126 at code point 254 means that code point 254 should be translated to code point 126.

The -X flag in the **qprt** command specifies the print file's code page name. When this value is 123, the formatter reads the table from the /usr/lib/lpd/pio/trans1/123 file and uses it for stage-1 translation.

## Stage two printer code page translation

In the second stage of code point translation, one or more stage-2 translation tables convert code points from the intermediate code page to those appropriate for the printer.

The **t0 - t9** attributes in the database colon file specify the full path names of stage-2 translation tables. Each of the **t0 - t9** attributes can specify multiple stage-2 translation tables by separating the names with commas. The print formatter reads in the stage-2 translation tables and chains them into a ring. Beginning with the table for the current printer code page, the formatter processes each character in the input print file. The first determination is whether the character is defined in that printer code page. In other words, the code point value is not larger than the number of code points in the table, and the value is not **SC**.

If the character is in the code page, the translated code point is sent to the printer. The formatter selects the printer code page by sending the appropriate printer command string. By convention, the printer command string's 2-character attribute name is at index 0 in the Command Names array. If the character is not in the code page, the formatter repeats the process for the next stage-2 translation table in the ring. If the formatter cannot find a translation table in the ring that can print the character, it prints a substitute character (underscore) instead.

The following example C language code generates a stage-2 translation table named **XYZ.999**, which translates code points from the intermediate code page to code points for the printer's code page. The **c1** attribute is assumed to contain the printer command string that will cause the printer to select code page **XYZ.999**.

```

#include <piostruct.h>
#include <fcntl.h>
/** Table to Translate Code Points for the Intermediate ***/
/** Code Page to Code Points for a Printer Code Page ***/
struct transtab table[] = {
/* 00 (000) */ {CP}, {CP}, {CP}, {CP},
.
.
.
/* FC (252) */ {63}, {CP}, {94,1}, {SC} };

/** Command Names for the Translate Table ***/
char cmdnames[][2] = {
{'c', '1'}, /* index 0 - select the code page */
{'e', 'b'} }; /* index 1 - next byte is graphic */

/** Write the Table To a File (Error Processing Not Shown) ***/
main() {
int fildes;
int num_commands = sizeof(cmdnames) / 2;
fildes = open("/usr/lib/lpd/pio/trans2/XYZ.999", O_CREAT |
O_WRONLY, \ 0664);
write(fildes, "PIOSTAGE2XLATE00", 16);
write(fildes, &num_commands, sizeof(num_commands));
write(fildes, cmdnames, sizeof(cmdnames));
write(fildes, table, sizeof(table));
return(0);
}

```

The {63} at code point 252 means that code point 252 should be translated to code point 63 before being sent to the printer. The {CP} at code point 253 means that code point 253 should be sent to the printer with no translation. The {94,1} at code point 254 means that code point 254 should be translated to code point 94 before it is sent to the printer. The ,1 in {94,1} indicates that the printer command string whose 2-character attribute name is at index 1 in the Command Names array should be sent to the printer before sending the code point. The SC at code point 255 indicates that the character at code point 255 in the intermediate code page cannot be printed by the printer code page described by this stage-2 translation table.

## Printer code page translation tables for multibyte code sets

A translation table consists of maps between code points that are not shared by the two code sets.

A printer backend can communicate with other code sets even if the code set is not supported by the `iconv` subroutine by using a translation table provided in the `/usr/lib/lpd/pio/transJP` directory.

When an input or an output code set is not supported by the `iconv` subroutine, the unsupported code set translates one of the code sets that are supported or directly to a process code set using the translation tables found in the `/usr/lib/lpd/pio/transJP` directory. Users with root authority can add new code sets for printers by creating translation tables.

The naming convention for new translation tables is *FromCodeSetName\_ToCodeSetName*. All translation tables must be defined in the `trans_dir` file. The **f\_cp** from code point in a translation table must be sorted in alphabetical order in advance.

The `trans_dir` and `codeset.alias` files are in the `/usr/lib/lpd/pio/transJP` directory. The `trans_dir` file format is:

```
FromCodeSetName ToCodeSetName NameofTranslationFile
```

Code set aliases are defined in the `codeset.alias` file. The `codeset.alias` file format is:

```
CodeSetName AliasName ...
```

For example, to print an MBCS file that was written with a new code set on an IBM-943 printer, use the following steps:

1. Create a translation table in the `/usr/lib/lpd/pio/transJP` directory. The naming convention for the new file is `NewCodeSetName_IBM-943`.
2. Define the translation table in the `trans.dir` file. The format to define a new code set named `NewCodeSet` is:

```
newcodeset IBM-943 newcodeset_IBM-943
```

3. Define the alias name in the `trans.alias` file, if needed.
4. Append the code set name as input code in a colon file, for example:

```
::Ti::[NewCodeSetName, ...]IBM-943, ...
```

## Xwindows fonts and the `qprt` command

MBCS printer backends use Xwindows fonts defined in the `/usr/lib/X11/fonts` directory to print characters that are not stored in the ROM of the printer.

The `-F` and `-I` (uppercase i) flags for the `qprt` command designate Xwindow fonts for the printer. The default value of these `qprt` command options are specified in the colon files as the value of the `_F` and `_I` attributes.

The `qprt -F` flag specifies a font. The full path name, font alias, or the Xwindow Logical Function Description (XLFD) of an Xwindow font can be used with the `-F` flag.

The `-I` flag follows a font path to find the Xwindow fonts and creates the `_I` attribute entry. The colon file format for the `_I` attribute is:

```
::_I::/usr/lib/X11/fonts/JP,/usr/lib/X11/fonts
```

If you specify another font path with the `qprt -I` command, the printer backend looks in the specified font path not in the default paths listed in the `_I` colon file. If the `-I` option has a null value, the backend assumes the default `/usr/lib/X11/fonts` directory.

To specify a specific Xwindows font file using a full path name, font alias, or XLFD, enter:

```
$ qprt -F '*-27-*-ibm_udcjp' foo.txt /* XLFD names list */
$ qprt -F IBM_JPN17 /* Font alias name */
```

The following example directs the MBCS printer backend to look in the `fonts.alias` and `fonts.dir` files to find the appropriate fonts for the code set specified with the `-X` option of the `qprt` command.

## Translation table example

The following is an example of a translation table.

```
#include <fcntl.h>
struct trans_table /*Translation Table Structure */
{
    unsigned int reserv1; /* Reserved */
    unsigned int f_cp; /* From code point */
    unsigned int reserv2; /* Reserved */
    unsigned int t_cp; /* To code point */
};
/*
 *Table to translate code points for input code set(NewCodeSet)
 *to code points for the process code set(IBM-943).
 */
struct trans_table table[] =
{
    {0x0,0x81ca,0x0,0xfa54},{0x0,0x9e77,0x0,0x954f},\
    {0x0,0x9e8d,0x0,0x938e},
    /* .... */
    [0x0,0xfad0,0x0,0x8d56}
};
/* Write the table. Error processing not shown. */
main()
{
```

```

int ftrans;
long hdsz = 32;          /* Header size          */
long cpsz = 4;          /* Code point size     */
long rsv1 = 0, rsv2 = 0; /* Reserved area       */
ftrans = open("usr/lib/lpd/pio/transJP/newcodeset_IBM-932",
              O_CREAT | O_WRONLY, 0664);
write(ftrans, "PIOSMBCSXLATE000", 16);
write(ftrans, &hdsz, sizeof(long));
write(ftrans, &cpsz, sizeof(long));
write(ftrans, &rsv1, sizeof(long));
write(ftrans, &rsv2, sizeof(long));
write(ftrans, table, sizeof(table));
return(0);
}

```

## Printer attachment files

Attachment files provide a simple interface for developers of printer attachments to create System Management Interface Tool (SMIT) screens that support new printer attachments.

Each new attachment type is defined in an attachment file. The attachment file contains the name of SMIT object IDs used to perform various printing tasks. The name of an attachment type is limited to 10 characters. To learn more about attachment files, see:

### SMIT interface for printer attachment files

Attachment files direct the branching from SMIT menus to SMIT object IDs.

Every attachment file controls the branching from some or all of these SMIT menu options:

- **Start a Print Job**
- **Add a Print Queue**
- **Add an Additional Printer to an Existing Queue**
- **Change/Show Print Queue Characteristics**
- **Change/Show Printer Connection Characteristics**
- **Remove a Print Queue**
- **Pre-Processing Filters**

For example, when the **Add a Print Queue** menu option is selected from a SMIT dialog screen, the first information required from the user is which attachment type is being used. The user selects the desired attachment type, and SMIT searches the attachment type file to discover which SMIT object ID file to branch to.

SMIT selectors and dialogs for new printer attachments must create dialogs that add, change, and remove a print queue for the new attachment type. The names of the new SMIT dialogs are placed in the attachment file. The dialog names in the file are automatically branched to when creating, changing, or removing queues for the new attachment type.

### Printer attachment file naming conventions

Attachment conventions are used for attachment files.

Attachment files must be named according to the following naming convention:

```
Attachment_type.attach
```

The *Attachment\_type* string must contain a unique string that identifies the attachment. All attachment files must be located in the `/usr/lib/lpd/pio/etc` directory. The following attachment files are supplied:

Item	Descriptor
<code>local.attach</code>	Contains the local system attached printers file.

Item	Descriptor
ascii.attach	Contains ASCII-terminal attached printers file.
file.attach	Contains the output-to-file attachment file.
remote.attach	Contains the remote print queues attachment file.

## Printer attachment file structure

Attachment files are ASCII files.

Each line in an attachment file defines a field using the following format:

```
FieldName = Value
```

The following field names have special meanings in the attachment file:

- **description**
- **seq\_num**
- **supported**
- **unsupported**

The following field names define SMIT selector IDs. The *Value* variable must contain a SMIT selector ID. The selector ID value of each field specifies the target of the branch. The SMIT fields are:

- **submit\_job**
- **add\_queue**
- **add\_printer**
- **remove\_queue**
- **printer\_conn**
- **change\_queue**
- **change\_filters**

Every attachment file should contain the **description**, **add\_queue**, and **remove\_queue** fields. All other fields are optional. Fields with a null value are treated as if the field were missing. There is no restriction on the other contents of an attachment file.

The following example attachment file is named `term_serv.attach`:

```
description = term_serv.cat,1,3; Printer Attached to Terminal Server
seq_num = 2
submit_job = term_serv_start_job
add_queue = term_serv_add
add_printer = term_serv_printer
remove_queue = term_serv_remove
printer_conn = term_serv_printer_conn
change_queue = term_serv_change
change_filters = term_serv_change_filters
unsupported = ibm6252,ibm6262
```

## Printer attachment file field definitions

Field definitions and their attachment type fields, formats for the field values, and practical examples of field values are described.

Field definition and types

Item	Descriptor
<b>description</b>	<p>Specifies the description string that appears on the SMIT Attachment type menu. The SMIT Attachment type menu lists all supported attachment types on the system. This field is required in order for the attachment type to appear on any list of supported types.</p> <p>The format of the description field value is:</p> <pre>Message_catalog,Set,Message_#; DefaultTextString</pre> <p>Values for <i>Message_catalog</i>, <i>Set</i>, and <i>Message_#</i> are not required. For example, the two following example entries create the same menu item in SMIT. The first example uses the <b>term_serv.cat</b> message catalog, set number <b>1</b>, and message number <b>3</b>. If the message cannot be found, SMIT uses the default text in quotes. In the second example, no message catalog is designated, and the quoted message is used in the menu automatically:</p> <pre>description = term_serv.cat,1,3; Printer Attached to Terminal Server description = Printer Attached to Terminal Server</pre>
<b>seq_num</b>	<p>Specifies the order in which a particular attachment type is displayed in the SMIT Attachment Type Selector menu. If this field is missing, the attachments are displayed in no particular order. For example, to display the attachment in the second position on the menu, enter:</p> <pre>seq_num = 2</pre>
<b>supported/unsupported</b>	<p>Define a list of printer types that are either supported or not supported by the attachment. The <b>supported</b> field value is used to generate the list of printers supported by the attachment type on the SMIT dialog screen. The two fields are mutually exclusive.</p> <p>The format of the value for the supported and unsupported fields is a comma-separated list of printer types. For example, to exclude the <b>ibm6252</b>, <b>ibm6262</b>, and <b>ibm4029</b> printers from the list of supported printers, enter:</p> <pre>unsupported = ibm6252, ibm6262, ibm4029</pre> <p>To show the <b>hplj-3</b>, <b>hplj-3-si</b>, and <b>hplj-2</b> printers on the list of available printer types, enter:</p> <pre>supported = hplj-3, hplj-3-si, hplj-2</pre>
<b>submit_job</b>	<p>Specifies the name of the SMIT selector ID to branch to in order to start a print job. If this field is missing, the <b>enq</b> dialog value is used. For example, to branch to the <b>term_ser_start_job</b> selector from the <b>Start a Print Job</b> menu option if the queue selected is of the <i>term_serv</i> attachment type, enter:</p> <pre>submit_job = term_serv_start_job</pre>

## Field definition and types

(continued)

Item	Descriptor
<b>add_queue</b>	<p>Specifies the name of the SMIT selector ID to branch to in order to add a print queue. For example, to branch to the <b>term_serv_add</b> selector ID from the <b>Add a Print Queue</b> menu option, enter:</p> <pre>add_queue = term_serv_add</pre>
<b>add_printer</b>	<p>Specifies the name of the SMIT selector ID to branch to in order to add a printer to an existing queue. Functionally, this adds an additional queue device to an existing queue. To branch to the <b>term_serv_printer</b> selector ID from the SMIT <b>Existing Print Queue</b> menu option, enter:</p> <pre>add_printer = term_serv_printer</pre>
<b>remove_queue</b>	<p>Specifies the name of the SMIT selector ID to branch to in order to remove a print queue. The <b>Remove</b> dialog screen removes any other queues, queue devices, virtual printers, and printer devices that were created at the time the print queue was created. To branch from the <b>Remove a Print Queue</b> menu option to the <b>term_serv_remove</b> selector ID, enter:</p> <pre>remove_queue = term_serv_remove</pre>
<b>printer_conn</b>	<p>Specifies the name of the SMIT selector ID to branch to in order to change the printer connection characteristics of a print queue. The port communication characteristics would typically be baud rate, parity, stop bits, and so on. To branch to the <b>term_serv_printer_conn</b> selector ID from the SMIT <b>Printer Port Communication Characteristics</b> menu option, enter:</p> <pre>printer_conn = term_serv_printer_conn</pre>
<b>change_queue</b>	<p>Specifies the name of the SMIT selector ID to branch to in order to change the characteristics of a printer queue. To branch to the <b>term_serv_change</b> selector ID from the SMIT <b>Change/Show Print Queue Characteristics</b> menu option, enter:</p> <pre>change_queue = term_serv_change</pre>
<b>change_filters</b>	<p>Specifies the name of the SMIT selector ID to branch to in order to change the pre-processing filters defined for a print queue. To branch to the <b>term_serv_change_filters</b> selector ID from the SMIT <b>Change/Show Pre-Processing Filters</b> menu option, enter:</p> <pre>change_filters = term_serv_change_filters</pre>

## Printer colon file limits field contents

The limits field is the fourth field in the printer colon file.

Colon file attributes have the following format:

```
Message_Catalog:Message_Number:Attr_Name:Limits:Value
```

Information in the **limits** field has two components. The first component is a single letter operator specifying an action. The letter value can be one of the following values: **C, D, E, F, G, H, I, L, M, Q, R, S,**

**T**, or **V**. The second component is the data. If the data is more than one character, it should be enclosed in square brackets ([ ]).

For example, if the **limits** field contained '**E#**', the **sm\_cmd\_opt** object class **entry\_type** field equals the numeric value assigned to #. The **entry\_type** field with a '**E#**' value takes only numeric input.

In another example, when the **limits** field contains '**[none,full,emulator=0,1,2]**' then the **sm\_cmd\_opt** object class contains the following values:

Field Name	Values
disp_values	none, full, emulator
aix_values	0,1,2

The **limits** field operators provide the following types of control in SMIT:

- Attribute display
- Characteristics of the field representing the attribute
- Attribute validation and the type of auxiliary operations (for example, pop-up menus or ring lists)

For example, in the **qprt** and **admvirprt** SMIT dialogs, the following rules apply:

- If **Dy** (the **limits** operator **D** with a value of **y** for yes) is specified in a **limits** field for an attribute, then that attribute is always displayed.
- If **Dn** (the **limits** operator **D** with a value of **n** for no) is specified in a **limits** field for an attribute, then that attribute is never displayed.

In **qprt** SMIT dialogs, the following additional rules apply:

- All attributes defined in the printer colon file that begin with a **\_** (underscore; for example, **\_j** and **\_i**) that are referenced in the pipeline are displayed.
- All attributes defined in the printer colon file that begin with a C combination flag (for example, **Cs** and **Ca**) and have their combination value referenced in the pipeline are displayed.

Rules specific to the **admvirprt** SMIT dialog are as follows:

- All attributes defined in the printer colon file beginning with either an **\_** (underscore) or a C combination flag are displayed, unless **Dn** is specified in their **limits** field.

## Printer colon file limits field operators

The **limits** field gives the creator of the colon file control over the type of ODM object built for a given attribute.

The **limits** field in the colon file contains two types of information:

- SMIT dialog information
- Validation information

The SMIT dialog information is used to build SMIT objects to represent colon file attributes in the Object Data Manager (ODM) database. Objects are used in the Print a File, Printer Setup, and Default Job Characteristics dialog screens.

All objects built for the **limits** field are part of the **sm\_cmd\_opt** object class. The **limits** field allows control over the following fields in a **sm\_cmd\_opt** object class:

- **id\_seq\_num**
- **entry\_type**
- **cmd\_to\_list\_mode**
- **required**
- **op\_type**

- **multi\_select**
- **cmd\_to\_list\_mode**
- **disp\_values**
- **aix\_values**
- **values\_msg\_file**
- **values\_msg\_get**
- **help\_msg\_id**
- **help\_msg\_loc**

These attributes can be set to be displayed always, never, or only if the attribute is referenced in the pipeline. For detailed descriptions of these fields, see "[sm\\_cmd\\_opt \(SMIT Dialog/Selector Command Option\) Object Class](#)" in *General Programming Concepts: Writing and Debugging Programs*.

The validation information is used to validate attribute values when the colon file is digested and when a print job is submitted.

### **Display operators**

Display operators define how multiple flags relate within the SMIT dialog, how the options for the flags are displayed, and what flags and options are available.

#### **Ite**

#### **m Descriptor**

- C** To support interdependent flags (for example, flags that affect typestyle and pitch), combinations of flags must be used. Typically, there is a single match between a SMIT dialog field and a command line flag. The combination flag operator allows one field in a SMIT dialog to represent more than one command line flag. Referenced flags should be marked as non-display (**Dn**) type for SMIT dialogs, so that only the combination flag is displayed instead of the individual flags.

The **C** operator syntax is:

```
C[xx,yy,...]
```

The *xx* and *yy* values are flag attributes. When a **C** attribute is defined, the **limits** field must also contain an **R** ring operator to define the popup list that is displayed to SMIT users. The **R** operator also defines how the options on the list map to command-line flags.

```
:111:Cs:C[_s,_p]R[Courier 10, Prestige 12= -s Courier
-p10, -s Prestige -p12]):-s %I_s -p %I_p
:999:_s:Dn:Courier
:222:_p:Dn:10
```

In this example, the **C** operator defines that the **-s** and **-p** flags are combination attributes. The **R** ring defines that when the Courier 10 option is chosen from the pop up menu, the flags on the command line are **-s Courier -p10**. The **-s %I\_s -p %I\_p** attribute value is resolved when the SMIT dialog is built and determines which item in the ring is displayed as the default.

- D** Designates the display mode. If the value is **y**, an object is built in the **sm\_cmd\_opt** object class. If the value is **n**, no object is built. The **D** operator allows programmers to suppress certain flags from being displayed in SMIT. If this operator is not specified, the object is built if the flag is referenced in the input pipeline.

**Item Descriptor**

**S** Designates the sequence number in the **id\_seq\_num** field of the **sm\_cmd\_opt** object class. The sequence number controls the position of the item in relation to other items in the dialog screen. If no **S** operator is specified, the dialog starts with the ID number 100, and items are numbered in the sequence they are found in the colon file.

The value for the **S** operator can be a string with a maximum length of 16 characters. For example, the following S operator entry places the item in position 100:

```
:100:_1:S[100]:60
```

**Field characteristics operators**

There are several field characteristics operators.

**Item Descriptor**

**E** Controls the **entry\_type** field of the **sm\_cmd\_opt** object. The possible values for the **E** option are:

**#**

Indicates that numerical entry is allowed.

**f**

Indicates that a file entry is allowed. A valid file name must be specified.

**n**

Indicates no entry is allowed. The field cannot accept typed input.

**r**

Indicates an alphanumeric entry is allowed.

**t**

Indicates that text entry is allowed.

**x**

Indicates that a hexacimal entry is allowed.

To allow numerical entry into the SMIT dialog field, enter the following:

```
:100:_L:E#:60
```

## Item

### Descriptor

**Q** Controls the value of the **required** field of the **sm\_cmd\_opt** object. The **required** field determines if the field value should be sent to the **cmd\_to\_exec** command for this dialog.

A single character specifies the value type. The default value is **n** which means that the flag and value for the **sm\_cmd\_opt** object is passed only if the field value is changed. The following are the possible values for the **required** field:

**n**

Represents no. Do not send flag unless user changes the initially displayed value. The **n** value is the default.

**y**

Represents yes. Always sends the **prefix** field and value of the **entry** field even if it is null.

**+**

Send the **prefix** field and value. The value must contain 1 non-blank character.

**?**

Always send the **prefix** field and values except when the value is null.

To ensure that the **prefix** field and the value of the **entry** field is always sent to **cmd\_to\_exec**, enter the following:

```
:100:_L:Qy:60
```

### ***Auxiliary operations and validation operators***

Auxiliary operations for the SMIT dialog determine the type of list and input required from the user.

Auxiliary operations for the SMIT dialog definitions determine the type of list and input required from the user. The types of lists available in the dialogs are list, multi-select list, range list, option ring, or multi-select option ring. The **limits** field operators that specify the type of auxiliary operation used by an attribute are **L**, **M**, **G**, and **R**.

Only one type of auxiliary operation is supported at a time. The default is **op\_type=n**. The **n** value means that no auxiliary operation is permitted for the field.

The following auxiliary operations are available:

**Item****m Descriptor**

- F** Allows control of the **cmd\_to\_list\_mode** field of the **sm\_cmd\_opt** object. The **cmd\_to\_list\_mode** field specifies how much of an item from a list should be used. The list is produced by the command specified in the **cmd\_to\_list** field object. For example, if the **cmd\_to\_list** field produced the following list:

```
60 (6 line per inch)
80 (8 line per inch)
66
```

Possible values for the **F** operator are:

- a** Get all fields. This is the default value.
- 1** Get the first field.
- 2** Get the second field.

To instruct SMIT to retrieve the first field from the list, enter:

```
:100:_1:F1:60
```

- G** Specifies a range list. The **G** operator gives the **cmd\_to\_list\_mode** an **r** value. The **r** value specifies that the information displayed by the **cmd\_to\_list** field is a range of information rather than a list. Validity checking is always done on a range. The data in a range list is in the form of **x..y (1..30)** or **..y (..30)** or **x.. (1..)** where **x** and **y** are integers and specify the upper and lower bounds of a range. Validity checking ensures that the attribute value is in the range specified. The integer can be negative; however the upper bound (**y** value) must be greater than or equal to the lower boundary (**x** value). To designate that the field list operation is a range between 50 and 100, enter:

```
:100:_1:G[50..100]:60
```

- H** Specifies the message catalog specification for help text for a corresponding attribute. The message catalog specification includes message catalog name, set number, and message number. The help text is used in SMIT dialog that use the attributes for which help is assigned.

To assign help to a flag, **-b**, from the **pioattr1 cat** dialog, enter:

```
:100:_b:H[pioattr1.cat,5,123]:60
```

- I** Specifies the publication specification for help text for a corresponding attribute. The publication specification includes values for the **help\_msg\_id**, **help\_msg\_base**, and **help\_msg\_book** fields in the **sm\_cmd\_opt** SMIT object class. The help text is used in the SMIT dialog that uses the attributes for which help is assigned.

To assign help to a flag, **-b**, from the publication specification, enter:

```
:100:_b:I[100145]:60
```

**Item****m Descriptor**

- L** Specifies that a pop-up list is displayed when the user selects F4. The pop up list allows users to select only one option from a given list of options. The pop up list is constructed from the **cmd\_to\_list** field values. The **op\_type** field value for a pop up menu is **l** (lowercase L).

Validity checking is done only when typed user input is prohibited. The entry type for a field that does not allow direct user input is **n**. The **cmd\_to\_list** field returns a newline-separated list. The values from that list are compared with the attribute value.

The possible values for the **L** operator are the shell command strings for the **cmd\_to\_list** field. The list generated from the command is a list of output values separated by newline characters. For example:

```
:100:_l:L[print "50\n55\n60\n65"]:60
```

- M** Specifies a multi-select list which allows users to select more than one value from a given list of options. The **M** operator works exactly like the **L** operator list except that the **multi-select** field must be set to an **m** value.

An example of a multi-select list operator entry is:

```
:100:_l:M[print "50\n55\n60\n65"]:60
```

- R** Specifies an option ring type of list. The **op\_type** field is set to **r**. A ring list differs from a regular list in that the user can continue to display list options by pressing either the tab (forward) or backtab (reverse) keys. When a ring list reaches the bottom of the options, it recycles to the top of the list. The ring list recycles in forward or reverse. A ring list becomes a regular list when the F4 key is pressed.

The option ring operator can control the **disp\_values**, **aix\_values**, **values\_msg\_file**, **values\_msg\_set**, and **value\_smg\_id** fields. The no message ID, just a message ID, message set and ID, or message set, catalog and ID are valid in a ring option list.

Validity checking is done if direct entry by the user is prohibited with the entry type value set to **n**. The ring has hardcoded values that are either stand-alone or are mapped to the base operating system values.

An example of stand-alone values would include a list of possible baud rates ('**1200,2400,9600,19200**') where the rate values themselves are used as the flag arguments.

An example of mapped values would be an attribute to designate which paper drawer on the printer is to be used. In this example, the three possible display values are lower drawer, upper drawer, and envelope feed. These possibilities are mapped to the base operating system flag operands '**0,1,2**'. The base operating system values are passed to the executed command.

Validity checking verifies that the attribute value is within the set of hardcoded values. The following examples illustrate several types of option ring lists:

```
:100:_l:R[0,1,2]:0
:100:_l:R[none,full,emulator=0,1,2]:0
:100:_l:R[;none,full,emulator=0,1,2]:0
:100:_l:R[21,none,full,emulator=0,1,2]:0
:100:_l:R[1,21;none,full,emulator=0,1,2]:0
:100:_l:R[pioattr9.cat,1,21;none,full,emulator=0,1,2]:0
```

- T** Allows multiple selections to be made from a pop up list and works identical to the **R** operator. The multi-select field equals **m**.

To allow multiple choices to be made from a pop up menu, enter:

```
:100:_l:T[none,full,emulator=0,1,2]:0
```

**Item Descriptor**

**V** Specifies additional validation for any attribute. The **V** operator does not affect how an ODM stanza is built for an attribute. The data specified with the **V** operator is colon file type code (**%** operators). The **%** operators do the validation. The colon file code resolves to one value. The value is either 0 or non-zero. If the resolved value is 0, then the attribute value is valid. If the value is non-zero, then the attribute value is invalid.

To verify that the value of **\_l** is in the range 0 to 100, enter:

```
:100:_l:V[%?%G_l%{100}%>%t1%e%?%G_l%{0}%<%t1%e0%;%]:60
```

### ***Adding a printer using the printer colon file***

You can use the printer colon file to add a printer.

Ensure that the following prerequisites are met before using the printer colon file to add a printer:

- The printer must be physically attached to your system.
- Compare the similarities and differences between the printer you want to add and the currently supported printers. To see a list of supported printers, use the **lsdev** (list devices) command.
- You must understand the printer colon files and their format. “Printer colon file conventions” on page 71 lists the conventions for printer and attribute names and values in colon files.

1. Select the supported printer that the new printer most closely emulates. You might need to consult the printer documentation.

2. Use the **mkvirprt** command to create a virtual printer definition by entering: `mkvirprt`.

Respond to the prompts, specifying the printer type you selected. Remember that all device names and queue names must begin with an alphabetic character.

3. Review the attribute values and descriptions with the **lsvirprt** command. Because you will need to compare these values in a later step, redirect the output to a temporary file by entering:

```
lsvirprt -q QueueName -d QueueDeviceName > tempfile
```

4. Display the output from the **lsvirprt** command, either in another window or as a hardcopy printout, and compare the attribute descriptions and values to those of the printer you are adding. Determine the changes to be made.

5. Copy the printer colon file from the Predefined Database directory (`/usr/lib/lpd/pio/predef`) to the Customized Database directory (`/var/spool/lpd/pio/@local/custom`).

6. Change the attribute values in the colon file as described in “Adding a New Printer Type” in *Kernel Extensions and Device Support Programming Concepts*. These will include the printer type (**mt** attribute), the printer description (**ml** attribute), and the printer-emulation mode (**ep** attribute).

7. Run the **chvirprt** command, specifying the queue name and the queue device name with no attribute values.

This action causes a digested version of the virtual printer definition to be built.

8. Verify that the newly defined printer prints correctly.

9. If you want to create a predefined virtual printer definition, do so with the **piopredef** command.

**Item Descriptor**

**%Sx** Pushes a pointer to the current string value for the **xx** attribute onto the stack. The only operation that can be performed on the string pointer is to use **%=** to compare the string with another string whose pointer is also on the stack.

## Item Descriptor

**%Lx** Pushes the length of the **xx** constant or variable string onto the stack. For example, if the value of attribute **ss** is **IJKLMN**, the sequence **ABC%Lss%dDEFG** produces the string **ABC6DEFG**. However, if **xx** is the attribute that contains the **%Lxx** sequence, the length will be the length of that part of the string that has been constructed when the **%Lxx** is encountered. For example, if the value of the **st** attribute is **ABC%Lst%dDEFG**, the constructed string for attribute **st** is **ABC3DEFG**.

### ***Installing support for additional printers***

Support for each printer is provided as a separately installable package.

To see a list of printers for which support has already been installed on your machine, enter:

```
smit lssprt
```

To install support for additional printers, enter:

```
smit printerinst
```

If your printer is not supported, you can configure it as a supported printer that is functionally similar to your printer. Otherwise, you can configure your printer as a generic printer. To do this, do one of the following:

- Select **Other** as the printer manufacturer or printer model when adding a print queue for the printer.
- Select **Other serial printer** or **Other parallel printer** when adding a printer device definition for the printer.

### *Supported printers*

The following is a list of supported printers.

- Bull Compuprint 4/51
- Bull Compuprint 4/54
- Bull Compuprint 914
- Bull Compuprint 914 N
- Bull Compuprint 922
- Bull Compuprint 923
- Bull Compuprint 924
- Bull Compuprint 924 N
- Bull Compuprint 956
- Bull Compuprint 970
- Bull Compuprint 1070
- Bull Compuprint PageMaster 200
- Bull Compuprint PageMaster 201
- Bull Compuprint PageMaster 411
- Bull Compuprint PageMaster 413
- Bull Compuprint PageMaster 422
- Bull Compuprint PageMaster 721
- Bull Compuprint PageMaster 815
- Bull Compuprint PageMaster 825
- Bull Compuprint PageMaster 1015
- Bull Compuprint PageMaster 1021

- Bull Compuprint PageMaster 1025
- Bull Compuprint PageMaster 1625
- Bull PR-88
- Bull PR-88 VFU Handling
- Bull PR-90
- [“Canon LASER SHOT LBP-B404PS/Lite” on page 156](#)
- [“Canon LASER SHOT LBP-B406S/D/E/G, A404/E, A304E” on page 156](#)
- [“Dataproducts LZR 2665 Laser Printer” on page 156](#)
- Dataproducts BP2000 Line Printer
- HP 2500C Color Printer
- [“Hewlett-Packard LaserJets II, III, IIISi, 3005, 4, 4Si, 4Plus, 4V, 4000, 5200, 5Si/5Si MX, 5Si Mopier, 4700 Color, 8000 Color, and 8500 Color” on page 156](#)
- HP LaserJet Color
- HP LaserJet 5000 D640 Printer
- HP LaserJet 8100 Printer
- HP Color LaserJet 4500 Printer
- [“IBM Personal Printer II Models 2380, 2381, 2390, 2391, 2380-2, 2381-2, 2390-2, 2391-2” on page 137](#)
- IBM 3112 Page Printer
- IBM 3116 Page Printer
- [“IBM 3812 Model 2 Page Printer” on page 137](#)
- [“IBM 3816 Page Printer” on page 138](#)
- [“IBM 4019 LaserPrinter and 4029 LaserPrinter” on page 138](#)
- [“IBM 4037 and IBM 4039 LaserPrinter” on page 139](#)
- IBM 4070 InkJet Printer
- [“IBM 4072 ExecJet” on page 139](#)
- IBM 4076 InkJet Printer
- [“IBM 4076 InkJet Printer” on page 139](#)
- IBM 4079 Color JetPrinter
- IBM 4201 Model 2 Proprinter II
- IBM 4202 Model 2 Proprinter II XL
- [“IBM Proprinter Models 4201-3, 4202-3, 4207-2, 4208-2” on page 140](#)
- [“IBM 4208-502, IBM 5572-B02, IBM 5573-H02, and IBM 5579-H02/K02” on page 140](#)
- IBM 4212 Proprinter 24P
- [“IBM 4216 Personal Page Printer, Model 031” on page 140](#)
- [“IBM 4216-510 and IBM 5327-011” on page 140](#)
- IBM 4224 Printer, Models 301, 302, 3C2, 3E3
- IBM 4226 Printer
- [“IBM 4234 Printer” on page 141](#)
- [“IBM 5202 Quietwriter III” on page 141](#)
- [“IBM 5204 Quickwriter” on page 141](#)
- [“IBM 5575-B02/F02/H02 and IBM 5577-B02/F02/FU2/G02/H02/J02/K02” on page 141](#)
- [“IBM 5584-G02/H02, IBM 5585-H01, IBM 5587-G01/H01 and IBM 5589-H01” on page 142](#)
- IBM 6180 Color Plotter

- IBM 6182 Auto Feed Color Plotter
- IBM 6184 Color Plotter
- IBM 6185-1 Color Plotter
- IBM 6185-2 Color Plotter
- IBM 6186 Color Plotter
- [“IBM 6252 Impactwriter and IBM 6252 Printer” on page 142](#)
- IBM 7372 Color Plotter
- IBM B02/F02/H02
- IBM B02/F02/FU2/G02/H02/J02/K02
- [“IBM InfoPrint 20” on page 146](#)
- [“IBM InfoPrint 32 Printer” on page 149](#)
- [“IBM InfoPrint 40 Printer” on page 153](#)
- [“IBM Network Color Printer” on page 142](#)
- [“IBM Network Printer 12, 17, and 24” on page 144](#)
- Lexmark 4039 Plus LaserPrinter
- Lexmark 4079 Color JetPrinter Plus
- Lexmark 4227 Forms Printer
- Lexmark ExecJet IIc
- [“Lexmark Optra Laser Printer” on page 165](#)
- [“Lexmark Optra Plus LaserPrinter” on page 168](#)
- [“Lexmark Optra Color 1200 Printer” on page 172](#)
- [“Lexmark Optra Color 40 Printer” on page 175](#)
- [“Lexmark Optra Color 45 Printer” on page 178](#)
- [“Lexmark Optra K 1220 Printer” on page 181](#)
- [“Lexmark Optra C Color LaserPrinter” on page 184](#)
- [“Lexmark Optra E LaserPrinter” on page 186](#)
- [“Lexmark Optra N LaserPrinter” on page 189](#)
- [“Lexmark Optra E310 Laser Printer” on page 194](#)
- [“Lexmark Optra M410 Laser Printer” on page 196](#)
- [“Lexmark Optra Se Laser Printer” on page 199](#)
- [“Lexmark Optra T Laser Printer Family” on page 202](#)
- [“Lexmark Optra W810 Laser Printer” on page 206](#)
- [“Lexmark Plus Printer Models 2380-3, 2381-3, 2390-3, 2391-3” on page 212](#)
- Lexmark ValueWriter 600
- [“OKI MICROLINE 801PS/+F, 801PSII/+F, 800PSIILT” on page 214](#)
- [“Printronix P9012 Line Printer” on page 214](#)
- [“QMS ColorScript 100 Model 20 Printer” on page 214](#)
- [“Texas Instruments OmniLaser 2115 Page Printer” on page 214](#)

### ***Pass-through mode***

Both virtual printers and the printer device driver can operate, or function, either in pass-through mode or in non-pass-through mode.

With pass-through mode, a data stream is "passed through" to the printer, byte by byte, unmodified. The mode of operation selected for a given job determines how or even if a data stream is processed. It is

important to understand the difference between the two modes, when each mode is in effect, and if the mode can be changed.

#### *Printer device driver pass-through mode*

The printer device driver itself, for example `/dev/lp0`, by default operates in non-pass-through mode.

A user can query or modify the operating rules for `/dev/lp0` by issuing the **sp1p** command. For example, below are the results of issuing the command `sp1p lp0` on a system with an IBM 4029 LaserPrinter defined as **lp0**. The results are output to the display element specified by the **TERM** environment variable.

```
device = /dev/lp0      (+ yes      ! no)
CURRENT FORMATTING PARAMETERS (ignored by qprt, lpr, and lp commands)
Note: -p + causes the other formatting parameters to be ignored.

-p !   pass-through?           -c +   send carriage returns?
-l 64  page length (lines)     -n +   send line feeds?
-w 80  page width (columns)    -r +   carriage rtn after line fee?
-i 0   indentation (columns)   -t +   suppress tab expansion?
-W !   wrap long lines?        -b +   send backspaces?
-C !   convert to upper case?  -f +   send form feeds?

CURRENT ERROR PROCESSING PARAMETERS
-T 600 timeout value (seconds) -e !   return on error?

CURRENT SERIAL INTERFACE PARAMETERS
-B 19200baud rate              -s 8   character size (bits)
-N !   enable parity?          -S !   two stop bits?
-P !   odd parity?
```

The `-p` parameter determines whether the printer device driver, `/dev/lp0`, will default to a pass-through mode of operation; the mode of operation can be overridden for a specific data stream. By default, the value of the `-p` parameter is **!**, or **no**. It is important to note that the question asked by the `-p` parameter is "Will the mode of operation be pass-through mode?"

If the value of the `-p` parameter is **!**, then all of the other parameters listed are honored by the device driver during data stream processing. Likewise, if the value of the `-p` parameter is **+**, or **yes**, then all of the other parameters are ignored during data stream processing.

Using the **sp1p** command to change the parameter values of the printer device driver does not affect the operation of the spooler. The **sp1p** command affects commands such as **cat** when they are used to access the device driver directly, bypassing the spooler. For example, the command

```
cat /etc/motd > /dev/lp0
```

opens `/dev/lp0` and writes the contents of the "message of the day" directly to the printer. The output on the printer is formatted similar to the following example:

```
This is a test version of /etc/motd, used to demonstrate
what happens when a printer device driver, such as
/dev/lp0, is placed into or taken out of passthru mode.
Printers will print either exactly what they are sent,
if you set the job conditions up correctly, or, on the
most current printers, you may be able to direct the
printer to perform certain mappings for you.
```

```
There are no carriage returns in
this file, and the only blank line occurs
immediate before this one.
```

Notice that the `-r` parameter dictates the mapping of each linefeed to a linefeed and carriage return if the value of `-p` is **!**. This is necessary as most UNIX-based operating systems only use linefeeds; unlike DOS or OS/2 or other operating systems, in UNIX-based operating systems a linefeed implies a carriage return.

While this works well with text editors and in other similar situations, it does not work with printers. Printers print only the data which they are sent. For example, issuing the two commands

```
splp -p+ lp0
```

```
cat /etc/motd > /dev/lp0
```

results in output similar to the following appearing on the printer.

```
This is a test version of /etc/motd, used to demonstrate
what happens when a printer device driver, such as
/dev/lp0, is placed into or taken out of passthru mode.
Printers will print either exactly what they are sent,
if you set the job conditions up correctly, or, on the
most current printers, you may be able to direct the
printer to perform certain mappings for you.
```

```
There are no carriage returns in
this file, and the only blank line occurs
immediately before this one.
```

In the first example, all of the device driver settings are honored. In particular, the mapping of a linefeed to a linefeed and a carriage return is turned on. When the device drivers are writing characters to the physical printer, it sends a carriage return after each linefeed. It also honors the settings for page width.

In the second example, the device driver is limited to simply writing each single-byte character of /etc/motd to the physical printer, without any mapping or other modification of the data stream occurring. When the first sentence of /etc/motd ends, the linefeed drops the printhead straight down one line; there is no carriage return to move the printhead back to the left margin. The first four letters of the word "printer, **prin**, are printed. At that point the printer itself, not the device driver, determines that the right margin has been reached and so prints a carriage return, returning the printhead to the left margin. Printing continues with the next character in the data stream.

In the second example, the job does not even print until the reset button on the printer is pressed. This is because the printer has not received enough data (characters) to automatically eject a page, and no formfeeds were sent to the printer to cause it to eject the page; the `-f` parameter on the device driver is ignored.

#### *Formatter filter pass-through mode*

After a job is submitted to the spooler it eventually passes to the formatter filter for processing and delivery to the printer device driver. The formatter filter always opens the printer device driver in pass-through mode.

After a job is submitted to the spooler it eventually passes to the formatter filter for processing and delivery to the printer device driver. The formatter filter always opens the printer device driver in pass-through mode. Jobs submitted to the spooler, as opposed to data streams that are sent directly to the printer device driver, are always processed or otherwise modified by a formatter filter and not by the printer device driver.

Like the printer device driver, the formatter filter also has two modes of operation: pass-through and non-pass-through. Again, the mode of operation selected for a given job determines how or even if a data stream is processed.

The `_d` attribute in a virtual printer definition (a digested colon file) specifies the input data stream type for the queue associated with that virtual printer. The virtual printer definition also specifies the formatter filter for that input data stream type. When the formatter filter is invoked to process a job, the process that runs the formatter (**pioformat**) filter checks the value of the `_d` attributes and decides whether to invoke the formatter filter in pass-through mode. If pass-through mode is selected, the formatter filter uses the `passthru()` subroutine to read the input stream and send it unmodified to the printer device driver. If pass-through mode is not selected, the formatter filter uses the `lineout` subroutine to process the input data stream line by line. In either case, the printer device driver was opened for writing in pass-through mode and performs no processing on the output data stream.

Note that input data streams such as PostScript are pass-through by definition; the processing is performed by the Postscript interpreter hardware on the printer.

Most of the printer device driver parameters that one can display or modify using the **splp** command also exist in the formatter filter. These parameters are stored in the digested version of the colon file for a given virtual printer. For example, the mapping between the printer device driver parameters and the corresponding parameters in the colon files for an ASCII queue on an IBM 4029 LaserPrinter is as follows:

Device driver parameters	Corresponding parameters in the colon files	
pass-through?	-p	_d
page length (lines)	-l	_l
page width (columns)	-w	_w
indentation (columns)	-i	_i
wrap long lines?	-W	_L
convert to uppercase?	-C	N/A
send carriage returns?	-c	_x
send linefeeds ?	-n	_x
carriage rtn after linefeed	-r	_x
suppress tab expansion?	-t	N/A
send backspaces?	-b	N/A
send formfeeds?	-f	_Z

The values of the parameters in the right column can be permanently set in the virtual printer definition. They can also be overridden at the time a job is submitted by using certain flags on either the **qprt** or **enq** commands.

### Virtual printer definitions

An IBM 4029 LaserPrinter supports four distinct data streams.

The root user can use the **mkvirprt** command to create both a queue and a virtual printer definition for each of the four data stream types. The root user can further use the **lsvirprt** command to view and modify the colon file underlying the virtual printer definition. For a system on which a queue of each type has been defined, issuing of the **lsvirprt** command results in the following list and query being displayed (queue names and device are chosen by the root user at queue creation time):

```

No. Queue      Device  Description
1   asc       lxx    4029 (IBM ASCII)
2   gl        lxx    4029 (Plotter Emulation)
3   pcl       lxx    4029 (HP LaserJet II Emulation)
4   ps        lxx    4029 (PostScript)

Enter number from list above (press Enter to terminate): ->

```

From this list, the root user enters the number corresponding to the virtual printer that he wants to view, format, or modify. The following message and prompt are then displayed.

```

To LIST attributes, enter AttributeName1 ... (* for all attributes)
To CHANGE an attribute value, enter AttributeName=NewValue
To FORMAT and EDIT an attribute value, enter AttributeName~v
To EDIT the attribute file, enter ~v
To terminate, press Enter:

```

There are several options at this point, one of which is to press Enter and terminate the **lsvirprt** command. The other options are as follows:

- Enter an asterisk (\*) to view a list of all attributes in the colon file along with their text descriptions from the message catalog.
- Enter the name of an attribute to view that attribute only, along with its text description from the message catalog.
- Enter the name of an attribute, an =, and a value to assign the attribute that value.
- Enter a ~v to engage in a vi session with the raw colon file.
- Enter the name of an attribute, immediately followed (no blank spaces) by a ~v to engage in a vi session with a heavily formatted version of the attribute.

Each of these five options will be discussed in the context of the **asc** queue and the associated virtual printer definition with its underlying colon file.

Entering an asterisk (\*) and pressing Enter will result in the following being displayed:

```

Name      Description                                     Value
__FLG    VALUES THAT MAY BE OVERRIDDEN WITH FLAGS ON THE
         COMMAND LINE
_0        (not used)
_1        (not used)
_2        (not used)
_3        (not used)
_4        (not used)
_5        (not used)
_6        (not used)
_7        (not used)
_8        (not used)
_9        (not used)
_A        stderr returned? 0: no; 1: yes, & pipelines; 2: 1
         yes, & values, pipelines
_E        Double-High Print. (!: no;  +: yes)
_F        (not used) Font file name
_G        Page format (!: use only printable page  +: use  !
         entire addressable area)
_H        Name To Replace Host Name On Burst Page
_I        Font ID (overrides pitch and type style)
_J        Restore the Printer at the End of the Print Job?  +
         (!: no;  +: yes)
_K        (not used)
_L        Wrap Long Lines (!: no;  +: yes)                +
_O        Type of Input Paper Handling (1: manual, 3:      3
         sheetfeed)
_Q        Paper or Envelope Size For the Paper Source     %IwQ
         Selected By the -O and -u Flag Values (Refer to
         the s0, s1, s2, s3, and s4 attributes); Default
         value: %IwQ
_S        High speed printing
_U        Unidirectional printing
_V        Vertical printing
_W        Double-Wide Print (!: no;  +: yes)                !
_X        Code Page Name For Print Data Stream (file with  IBM-850
         same name in dir. "d1")
_Y        Duplex Output (0: Simplex 1: Duplex Long-Edge 2:  0
         Duplex Short-Edge)
_Z        Issue Form Feed Between Copies & At Job End (!:  +
         no;  +: yes)
:

```

The output is formatted by the **pg** command, hence the full colon (:) at the bottom of the display. The output above is only the first full screen. The rest is available through the normal **pg** subcommands but will not be displayed here for reasons of brevity. This output is view-only; the attributes cannot be modified.

Entering the name of an attribute, such as **\_w** (page width in columns), and pressing Enter will result in something like the following being displayed.

```

Name      Description                                     Value
_w        Page Width (characters); Default Value: %IwX       %IwX
         (value based on paper size specified with s0 -
         s5 attributes)

```

```

To LIST attributes, enter AttributeName1 ... (* for all attributes)
To CHANGE an attribute value, enter AttributeName=NewValue
To FORMAT and EDIT an attribute value, enter AttributeName~v
To EDIT the attribute file, enter ~v
To terminate, press Enter:

```

The name of the attribute is displayed, along with its text description from the message catalog and its current value. The prompt is also displayed again. Note that you do not have to type the underscore for attributes whose name begin with an underscore. For example, the results above could have been obtained by entering **w**. This output is view-only; the attribute cannot be modified.

Other attributes may be much harder to read in this form. For example, entering **ia** at the prompt and pressing Enter will result in output similar to the following being displayed:

Name	Description	Value
ia	ASCII	%Ide/pioformat -@% Idd/%Imm -!%Idf/pi of5202 -l%IwL -w%I wW %f[beginpqstuvx yzEGIJLOQWXZ] %Uh

```

To LIST attributes, enter AttributeName1 ..(* for all attributes)
To CHANGE an attribute value, enter AttributeName=NewValue
To FORMAT and EDIT an attribute value, enter AttributeName~v
To EDIT the attribute file, enter ~v
To terminate, press Enter:

```

Entering the name of an attribute, an =, and a value, and pressing Enter will result in the attribute being assigned that value, and the new value being displayed. For example, entering **\_w=60** and pressing Enter, or entering **w=60** and pressing Enter, will result in something like the following being displayed:

```

To LIST attributes, enter AttributeName1 ..(* for all attributes)
To CHANGE an attribute value, enter AttributeName=NewValue
To FORMAT and EDIT an attribute value, enter AttributeName~v
To EDIT the attribute file, enter ~v
To terminate, press Enter: w=60

```

Name	Description	Value
_w	COLUMNS per page	60

```

To LIST attributes, enter AttributeName1 ..(* for all attributes)
To CHANGE an attribute value, enter AttributeName=NewValue
To FORMAT and EDIT an attribute value, enter AttributeName~v
To EDIT the attribute file, enter ~v
To terminate, press Enter:

```

The new value of **w** is displayed. (This example would result in the page width for this queue being permanently set to 60 columns.)

Entering **~v** and pressing Enter will result in something like the following being displayed:

```

:056:_FLG::
:625:CB:S[B]DyEn:
:626:CC:S[C]DyEn:
:627:CD:S[D]DyEn:
:628:CE:S[E]DyEn:
:629:CF:S[F]DyEn:
:630:CG:S[G]DyEn:
:622:Ca:DyS[G500]I[1810532]EnR[pioattr1.cat,1,631;(diag1) - do not print job; di
splay main pipeline and pre-processing filter,(diag2) - do not pr
int job; displa
y all pipelines and filters,(display) - print job; display all pi
pelines and fil
ters,(ignore) - print job; ignore stderr produced by filters,(nor
mal) - print jo
b; exit if filters produce stderr=-a1,-a0\x27 \x27-A3,-a0\x27 \x2
7-A2,-a0\x27 \x
27-A0,-a0\x27 \x27-A1]:%?%G_a%t-a%I_a%e-a%I_a\x27 \x27-A%I_A%;
:674:Cs:S[B005]I[1810500]EnC[_s,_p]R[%'W0]:-s%I_s\x27 \x27-p%I_p
:013:_A:DnEnR[0,1,2,3]:1
:789:_E:S[B020]I[1810501]%IWY:!

```

```

:790:_G:S[E025]I[1810502]%IWY:!
:621:_H:S[F350]I[1810503]Dy:
:024:_I:Dn:
:791:_J:S[C950]I[1810533]%IWY:+
:792:_K:Dn:
:793:_L:S[D020]I[1810504]%IWY:+
:697:_O:DnEnR[1,3]:3
:683:_Q:S[E020]I[1810505]En%IW6:%IWQ
:794:_W:S[B025]I[1810506]%IWY:!
:795:_X:S[D030]I[1810507]EtL[/usr/bin/ls -l /usr/lib/lpd/pio/tran
s1 | /usr/bin/s
ed '^850$/d']V[%`WX]:IS08859-1
:808:_Y:Dn:
:614:_Z:Dn%IWY:+
:063:_a:DnEnR[0,1]:0
:635:_b:S[D010]I[1810508]E#G[0..%?%G_1%{0}%=%t%e%G_1%G_t%-%{1}%-%
d%;]:0
:658:_d:S[C925]I[1810509]EnL[%IW2]F1:a
:615:_e:S[B010]I[1810510]%IWY:!
:659:_f:S[C930]I[1810535]EtL[%IW3]F1V[%`W7]Dy:
:623:_g:S[C250]I[1810511]E#G[1..]:1
"/var/spool/lpd/pio/@local/custom/asc:lp1" 318 lines, 15318 chara
cters

```

As is indicated by the last line of this sample, this is a **vi** session with the raw, unformatted version of the undigested printer colon file for this queue. If a **write** command is issued in this **vi** session, the definition is digested by the **piodigest** command and a new version of the digested printer colon file is created.

The most powerful option in **lsvirprt** is to type an attribute name followed by a **~v**. For example, entering **ia~v** will result in something like the following being displayed:

```

ASCII
ia = %Ide/pioformat -@%Idd/%Imm -!%Idf/piof5202 -l%IwL -w%IwW %f[
begijpqstuvwxyzEGIJLOQWXZ] %Uh

%Ide      INCLUDE: (Directory Containing Miscellaneous Modules)
'/pioformat -@'
%Idd      INCLUDE: (Directory Containing Digested Data Base Fil
es)
'/
%Imm      INCLUDE: (File Name Of (Digested) Data Base; Init. By
"piodigest" (mt.md.mn.mq:mv))
'-!'
%Idf      INCLUDE: (Directory Containing Loadable Formatter Rou
tines)
'/piof5202 -l'
%IwL      INCLUDE: (Page Length In Chars, Using Length From Dat
a Base (used in pipelines))
'-w'
%IwW      INCLUDE: (Page Width In Characters, Using Width From
Data Base (used in pipelines))
'|
%f[begijpqstuvwxyzEGIJLOQWXZ] For Each Flag x on Command Line: "
-xArgument" -> OUTPUT
%Uh      Indicate to piobe: Pass the Following Attributes to s
ubsequent printer commands

/tmp/asc:lp1.ia" 24 lines, 1001 characters

```

As is indicated by the last line of the sample, this is again a **vi** session, but this time the attribute definition has been formatted and annotated. Here the root user can modify the attribute definition; if a **write** command is issued in this **vi** session, the definition is digested by the **piodigest** command and a new version of the digested printer colon file is created.

The formatted sample is divided into three parts. The first part is the **ia=**, followed by the attribute definition strung out horizontally. The second part is the annotations on the right-hand side of the **vi** session, the comments that describe the function of each particular printer colon file escape sequence. The third part is the formatted printer colon file escape sequences aligned on the left margin of the **vi** session. These escape sequences also have a horizontal formatting component; indentations are used to clarify the flow of if-then-else statements, nested or otherwise.

The first and second parts can be edited, but the editing changes have no effect and should therefore not be performed. Any changes made to the initial definition of the attribute or to the annotations will be ignored by **pidigest** if you write the file. It is the third part, the formatted attribute definition, that can be edited. If this part is edited and written, **pidigest** will issue an error message if any syntax errors are found. As with normal programming languages, you can make logic errors, but not syntax errors.

For practical examples of modifying printer colon files, see [“Modification of the mi, mp, and \\_d attributes on a PostScript queue”](#) on page 109.

### **Modification of the mi, mp, and \_d attributes on a PostScript queue**

The root user can modify the **mi**, **mp**, and **\_d** attributes in the virtual printer definition so that the queue backend can determine the file type (PostScript or non-PostScript ASCII) and set the print environment accordingly.

Input data stream attributes store the pipelines for different input data stream types. For more information, see [“Virtual printer input data stream attributes”](#) on page 59. The definition for a generic PostScript printer has four input data stream pipelines: **ia** (extended ASCII), **in (troff)**, **ip** (passthru), and **is** (PostScript). The **\_d** attribute in the colon file controls which of the four input data stream processing pipelines will, by default, be used. The default value for **\_d** on a generic PostScript queue is **s** (PostScript), so the pipeline defined by **is** will be used.

The **mi** attribute uses single, comma-separated characters to name input data stream types. The **mp** attribute uses comma-separated strings to identify input data stream types. There is a one-to-one pairing between the characters of **mi** and the strings of **mp**.

The default value of **mi** for a generic PostScript virtual printer is **s**. The default value for **mp** is **%%!**; the first two characters of a PostScript file are **%!** (Recall that printer colon file escape sequences all begin with a **%** so, to use a literal **%** in an attribute definition, it must be escaped with another **%**.) The virtual printer will interpret all files beginning with **%!** as being of data stream type **s**, and use the **is** pipeline. Because non-PostScript ASCII file do not begin with a **%!** , they will not be printed by this queue.

Submitting a non-PostScript ASCII job to a PostScript queue with a generic PostScript virtual printer definition will result in the loss of the job. To enable ASCII printing on this queue, the root user can use the **lsvirprt** command to modify the referenced attributes as follows:

- **mi=a,s**
- **mp=,%%!**
- **\_d=%mi**

Use the **lsvirprt** command to select the generic PostScript queue. The following prompt will appear:

```
To LIST attributes, enter AttributeName1 ..(* for all attributes)
To CHANGE an attribute value, enter AttributeName=NewValue
To FORMAT and EDIT an attribute value, enter AttributeName~v
To EDIT the attribute file, enter ~v
To terminate, press Enter:
```

At the prompt:

- Enter **mi=a,s**.
- Enter **mp=,%%!**.
- Enter **d=%mi**.

After each attribute redefinition is entered, the attribute's new value will be displayed, followed by the prompt.

This new value sets up a pairing of input data stream type **a** (extended ASCII) with any string at all, and input data stream type **s** (PostScript) with the string **%!** Input data streams that do not begin with a **%!** will be processed by the **ia** pipeline, and all input data streams that do begin with a **%!** will be processed by the **is** pipeline.

**Note:** With a generic PostScript virtual printer without the modifications described above, it is possible to print non-PostScript ASCII files by overriding the input data stream type from the command line. For example, the `d` flag of **qprt** can be used as follows:

```
qprt -Pqueue_name -da /etc/motd
```

This command requests that the file named `/etc/motd` be printed on the queue named **queue\_name** and that the input data stream be treated as ASCII (the **ia** pipeline will be used).

### ***Printer colon file and the piobe command***

The **piobe** command is a spooler backend program called by the **qdaemon** program to process a print job.

The **piobe** command can generate diagnostic output. A specific example of this diagnostic output is used in the following discussion to examine these points:

- How **piobe** uses printer colon files.
- How printer colon file escape sequences are evaluated to resolve path names.
- How printer colon file escape sequences are evaluated to resolve page length.
- How printer colon file escape sequences are evaluated to resolve page width.

This discussion is intended for readers who need to understand printer colon file escape sequences at a low level, perhaps because they want to write their own colon file for a unique and unsupported printer. Before reading this discussion, you should be familiar with these topics:

- [“Printer colon file escape sequences” on page 65](#)
- [“Virtual printer definitions” on page 105](#)

The following command uses the `-a1` flag/argument to request diagnostic data from the **piobe** backend. The remainder of the command specifies that the job be processed by the queue named **asc**, that three copies of the file named `/etc/motd` be printed in a 12-point Courier font rotated 90 degrees, that the job be preprocessed by the **pr** filter, and that any messages generated by the job should be mailed to the user that submitted the job.

```
qprt -a1 -Pasc -fp -z1 -p12 -scourier -C -N3 /etc/motd
```

Issuing this command results in mail similar to the following being sent to the user that issued the command:

```
Message from qdaemon:
=====> MESSAGE FROM PRINT JOB 31 (/etc/motd) <====
0782-034 Below is the preview information requested with the -a1
flag.
      No files will be printed.
```

```
PRINTER:
[devices.cat,71,66;IBM 4029 LaserPrinter] (ASCII)
```

```
FLAG VALUES:
a=1, b=0, d=a, e=!, f=p, g=1, h=, i=0, j=1, l=48, p=12, q=, s=cou
rier, t=0,
u=1, v=6, w=128, x=2, y=!, z=1, A=1, B=nn, C=+, E=!, G=!, H=, I=,
J=+, L=+,
N=3, O=3, P=ascx:lxx, Q=1, W=!, X=ISO8859-1, Z=+
```

```
PIPELINE OF FILTERS:
/usr/bin/pr
  -l48
  -w128 /etc/motd |
/usr/lib/lpd/pio/etc/pioformat
  -@/var/spool/lpd/pio/@local/ddi/ibm4029.asc.lp1.asc:lp1
  -!/usr/lib/lpd/pio/fmtrs/piof5202
  -l48
  -w128
  -p12
```

```
-scourier
-z1
```

The mail specifies several items:

- The physical printer that would have been used.
- The values of the flags that pertain to this spooler queue.
- The pipeline of filters that would have been executed.

The flags values used on the command line, a1, Pasc, fp, z1, p12, scourier, C, and N3, can be seen in the section of the mail labeled FLAG VALUES.

Of more interest is the section of the mail labeled PIPELINE OF FILTERS. Here the pipeline of filters determined by **pio** and constructed by the shell can be seen. The **pr** filter will pre-process the print job (/etc/motd) and send its output to **pioformat**, the device-independent formatter driver.

This is a good place to examine how **pio** uses the virtual printer definition associated with the spooler queue named **asc**. The colon file (which contains the virtual printer definition for this queue) uses the attribute **ia** to specify the input data stream pipeline (the PIPELINE OF FILTERS section above) for ASCII jobs. The value of **ia** for this queue is:

```
%Ide/pioformat -@%Idd/%Imm -!%Idf/piof5202 -l%IwL -w%IwW
%f[beginpqstuvwxyzEGIJLQWXZ] %Uh
```

The **lsvirprt** command can be used to format **ia** so it reads as follows:

```
%Id          INCLUDE: (Directory Containing Miscellaneous Modules)
'/pioformat -@'
%Idd         INCLUDE: (Directory Containing Digested Data Base
Files)
 '/'
%Imm         INCLUDE: (File Name Of (Digested) Data Base; Init. By
"piodigest" (mt.md.mn.mq:mv))
 ' -!'
%Idf         INCLUDE: (Directory Containing Loadable Formatter
Routines)
'/piof5202 -l'
%IwL        INCLUDE: (Page Length In Chars, Using Length From Data
Base
          (used in pipelines))
 ' -w'
%IwW        INCLUDE: (Page Width In Characters, Using Width From
Data Base
          (used in pipelines))
 ' '
%f[beginpqstuvwxyzEGIJLQWXZ] For Each Flag x on Command
Line:"-xArgument" ->
          OUTPUT
 ' '
%Uh         Indicate to pio: Pass the Following Attributes to
subsequent
printer commands
```

The **%Id** resolves to /usr/lib/lpd/pio/etc, the directory that contains miscellaneous modules. The '/pioformat -@' is appended, without the single quotes, to the previous string, becoming /usr/lib/lpd/pio/etc/pioformat, otherwise known as the full path name to the formatter driver. The -@ after **pioformat** is a flag to the **pioformat** command which, in this instance, specifies the full path name of the digested database file to be accessed.

The value of the -@ flag is specified by the concatenation of **%Idd**, '/', and **%Imm**. The value of **%Idd** is defined in the colon file as **%I@5/ddi**. The **@5** is an automatic variable whose value is /var/spool/lpd/pio/@local, so **%Idd** resolves to /var/spool/lpd/pio/@local/ddi. The '/', without the single quotes, is appended to that path. **%Imm** is defined in the colon file as **mt.md.mn.mq.mv**, and other virtual printer attributes. These attributes define:

- **mt** - Printer type
- **md** - Output data stream type
- **mn** - Device name

- **mq** - Queue name (name of a queue stanza in /etc/qconfig)
- **mv** - Virtual printer name (name of a corresponding device stanza in /etc/qconfig)

These file virtual printer attributes are initialized by the **piodigest** command at the time the queue and virtual printer are created. The combination of the five is unique in the virtual printer database.

For this queue, the value of **mt.md.mn.mq.mv** is `ibm4029.asc.lp1.asc.lp1`. Thus the value of the `-@` flag to **pioformat** becomes `/var/spool/lpd/pio/@local/ddi/ibm4029.asc.lp1.asc.lp1`, the full path of the digested database file defining the virtual printer associated with this queue (**asc**).

The `'-!'` is a second flag to **pioformat**, specifying the full path name of the device-dependent formatter to be loaded, linked, and driven at runtime by the formatter driver, **pioformat**. It is here that you can see how and where the runtime connection between these two modules occurs.

The value of the `-!` flag is specified by the concatenation of the remainder of the printer colon file escape sequences shown in the formatted form of the **ia** attribute, beginning with **%Idf** and **'/piof5202 -l'**.

The value of **%Idf** is defined in the colon file as **%I@4/fmtrs**. The **@4** is an automatic variable whose value is `/usr/lib/lpd/pio`, so **%Idf** resolves to `/usr/lib/lpd/pio/fmtrs`. The **'piof5202 -l'**, without the single quotes, is appended to this string, so the value of the `-!` flag to this point becomes `/usr/lib/lpd/pio/fmtrs/piof5202 -l`. The `-l` is a flag to **piof5202**, the device-dependent formatter for an ASCII data stream on an IBM 4029 LaserPrinter, that specifies page width in characters.

For information on the calculation of the argument to the `-l` flag, **%IwL**, see [“Calculation of page length using printer colon file escape sequences”](#) on page 112.

### **Calculation of page length using printer colon file escape sequences**

You can use printer colon file escape sequences to calculate page length.

The printer colon file for an ASCII queue on an IBM 4029 LaserPrinter defines page length, in lines, with the work attribute **wL**. Obtaining a numeric value for **wL** involves evaluating embedded references in the definition of **wL**. As formatted by the **lsvirprt** command, **wL** is defined as follows:

```
Page Length In Chars, Using Length From Data Base (used in
pipelines)
wL = %?%C1%t%f!l%e%I_1%;
```

```
%?          <IF>
%?          %C1      PUSH: (1 If -l Flag on Command Line; Otherwise 0)
%t          <THEN>
%t          %f!l    For Each Flag x on Command Line: "-xArgument" ->
OUTPUT
%e          <ELSE>
%e          %I_1    INCLUDE: (LINES per page)
%;          <END>
```

The **%C1** checks to see if the `l` flag was used on the command line; if it was, then a **1** is pushed onto the stack, else a **0** is pushed onto the stack. In this case, the `l` flag was not used on the command line so a **0** is pushed onto the stack. The **%t** checks for a true (non-zero) value on the stack and, not finding one, executes the **%e** (else) construct **%I\_1**.

**\_1** is defined as **%IwY**, shown below as formatted by the **lsvirprt** command.

```
Default Page Length (lines)
wY = %?%G_z%{1}%&%t%GwJ%e%GwK%;%G_v%*%{300}%/%d
```

```
%?          <IF>
%?          %G_z    PUSH: (Page ORIENTATION)
%?          %{1}   PUSH: (Integer Constant 1)
%?          %&    PUSH: (pop2 & pop1) -- Bitwise AND
%t          <THEN>
%t          %GwJ   PUSH: (Primary Page Width (-z 0) or Secondary Page
                        Length (-z1), in pels)
%e          <ELSE>
%e          %GwK   PUSH: (Primary Page Length (-z 0) or Secondary Page
                        Width (-z1), in pels)
%;          <END>
%G_v        PUSH: (LINE DENSITY (lines per inch))
```

```

%*      PUSH: (pop2 * pop1)
%{300} PUSH: (Integer Constant 300)
%/      PUSH: (pop2 / pop1)
%d      POP -> ASCII String -> OUTPUT

```

The calculation of **\_l** begins by pushing the value of **\_z**, page orientation, onto the stack. The job submission command being used in this example, `qprt -a1 -Pasc -fp -z1 -p12 -scourier -C -N3 /etc/motd`, specifies a **z** value of **1**, so a **1** is pushed onto the stack. The **%{1}** pushes another **1** onto the stack, after which the **%&** pops the top two values (both **1s**) off the stack and performs a bitwise AND with the two values. The result of the bitwise AND, a **1**, is pushed onto the stack.

**Note:** The test is a bitwise AND instead of a simple test for equality because the legal values for the **z** flag are **0**, **1**, **2**, and **3**, corresponding to the legal number of 90 degree rotations that can be applied to a printed page.

The next **%t** finds a **1** on the stack and so the **then** clause, **%GwJ**, is resolved before any more work is done on resolving **\_l**.

As formatted by **lsvirprt**, **wJ** is defined as follows:

```

Primary Page Width (-z 0) or Secondary Page Length (-z1), in pels
wJ = %G_Q%Pq%?%Gwu%{3}%<%t?%gq%{1}%=%t%{2400}%e%gq%{2}%=%t%{2400}
}%e%gq%{3}%=%t%{1999}%e%gq%{4}%=%t%{2330}%e%{2025}%;%e?%gq%{1}%=%
%t%{1012}%e%gq%{2}%=%t%{1012}%e%gq%{3}%=%t%{1087}%e%gq%{4}%=%t%{1
149}%e%gq%{5}%=%t%{1763}%e%{1928}%;%;%d

```

```

%G_Q      PUSH: (PAPER SIZE override for input paper source)
%Pq      POP -> Internal Variable q
%?      <IF>
%Gwu     PUSH: (Calculate value for paper source based on _
          0 and _u.)
%{3}     PUSH: (Integer Constant 3)
%<      PUSH: (pop2 < pop1 ?)
%t      <THEN>
%?      <IF>
%gq     PUSH: (Internal Variable q)
%{1}    PUSH: (Integer Constant 1)
%=     PUSH: (pop2 = pop1 ?)
%t      <THEN>
%{2400} PUSH: (Integer Constant 2400)
%e      <ELSE>
%gq     PUSH: (Internal Variable q)
%{2}    PUSH: (Integer Constant 2)
%=     PUSH: (pop2 = pop1 ?)
%t      <THEN>
%{2400} PUSH: (Integer Constant 2400)
%e      <ELSE>
%gq     PUSH: (Internal Variable q)
%{3}    PUSH: (Integer Constant 3)
%=     PUSH: (pop2 = pop1 ?)
%t      <THEN>
%{1999} PUSH: (Integer Constant 1999)
%e      <ELSE>
%gq     PUSH: (Internal Variable q)
%{4}    PUSH: (Integer Constant 4)
%=     PUSH: (pop2 = pop1 ?)
%t      <THEN>
%{2330} PUSH: (Integer Constant 2330)
%e      <ELSE>
%{2025} PUSH: (Integer Constant 2025)
%;      <END>
%e      <ELSE>
%?      <IF>
%gq     PUSH: (Internal Variable q)
%{1}    PUSH: (Integer Constant 1)
%=     PUSH: (pop2 = pop1 ?)
%t      <THEN>
%{1012} PUSH: (Integer Constant 1012)
%e      <ELSE>
%gq     PUSH: (Internal Variable q)
%{2}    PUSH: (Integer Constant 2)
%=     PUSH: (pop2 = pop1 ?)
%t      <THEN>
%{1012} PUSH: (Integer Constant 1012)
%e      <ELSE>
%gq     PUSH: (Internal Variable q)

```

```

    %i3} PUSH: (Integer Constant 3)
    %= PUSH: (pop2 = pop1 ?)
%t    <THEN>
    %i1087} PUSH: (Integer Constant 1087)
%e    <ELSE>
    %gq PUSH: (Internal Variable q)
    %i4} PUSH: (Integer Constant 4)
    %= PUSH: (pop2 = pop1 ?)
%t    <THEN>
    %i1149} PUSH: (Integer Constant 1149)
%e    <ELSE>
    %gq PUSH: (Internal Variable q)
    %i5} PUSH: (Integer Constant 5)
    %= PUSH: (pop2 = pop1 ?)
%t    <THEN>
    %i1763} PUSH: (Integer Constant 1763)
%e    <ELSE>
    %i1928} PUSH: (Integer Constant 1928)
%;    <END>
%e    <END>
%d    POP -> ASCII String -> OUTPUT

```

The calculation of **wj** begins by pushing the value of **\_Q**, the paper size override for the input paper source, onto the stack. The value of **\_Q** is defined as **%iwQ**. As formatted by the **lsvirprt** command, **wQ** is defined as follows:

```

Paper or Envelope Size For the Paper Source Selected By the -0
and -u Flag Values (Refer to the s0, s1, s2, s3, and s4
attributes)
wQ =
%?%GWu%{0}%=%t%Gs0%e%GWu%{1}%=%t%Gs1%e%GWu%{2}%=%t%Gs2%e%GWu%{3}%
=%t%Gs3%e%Gs4%;%d

```

```

%?    <IF>
    %GWu    PUSH: (Calculate value for paper source based on
    _0 and _u.)
    %i0}    PUSH: (Integer Constant 0)
    %=     PUSH: (pop2 = pop1 ?)
%t     <THEN>
    %Gs0    PUSH: (PAPER SIZE for manual paper feed)
%e     <ELSE>
    %GWu    PUSH: (Calculate value for paper source based on
    _0 and _u.)
    %i1}    PUSH: (Integer Constant 1)
    %=     PUSH: (pop2 = pop1 ?)
%t     <THEN>
    %Gs1    PUSH: (PAPER SIZE for tray 1 (upper))
%e     <ELSE>
    %GWu    PUSH: (Calculate value for paper source based on
    _0 and _u.)
    %i2}    PUSH: (Integer Constant 2)
    %=     PUSH: (pop2 = pop1 ?)
%t     <THEN>
    %Gs2    PUSH: (PAPER SIZE for tray 2 (lower))
%e     <ELSE>
    %GWu    PUSH: (Calculate value for paper source based on
    _0 and _u.)
    %i3}    PUSH: (Integer Constant 3)
    %=     PUSH: (pop2 = pop1 ?)
%t     <THEN>
    %Gs3    PUSH: (ENVELOPE SIZE for envelope feeder)
%e     <ELSE>
    %Gs4    PUSH: (ENVELOPE SIZE for manual envelope feed)
%;     <END>
%d     POP -> ASCII String -> OUTPUT

```

The calculation of **wQ** begins by pushing the value of **Wu**, onto the stack. As formatted by the **lsvirprt** command, the value of **Wu** is defined as follows:

```

Calculate value for paper source based on _0 and _u.
Wu =
%?%CO%t%?%G_0%{1}%=%t%?%Cu%t%?%G_u%{2}%>%t%{4}%e%{0}%;%e%{0}%;%e%
G_u%;%e%G_u%;%d

```

```

%?    <IF>
    %CO    PUSH: (1 If -0 Flag on Command Line; Otherwise 0)

```

```

%t      <THEN>
%?      <IF>
%G_0    PUSH: (Type of INPUT PAPER HANDLING (backward
compatibility
        purpose only))
%{1}    PUSH: (Integer Constant 1)
%=      PUSH: (pop2 = pop1 ?)
%t      <THEN>
%?      <IF>
%Cu     PUSH: (1 If -u Flag on Command Line; Otherwise 0)
%t      <THEN>
%?      <IF>
%G_u    PUSH: (Input PAPER SOURCE)
%{2}    PUSH: (Integer Constant 2)
%>     PUSH: (pop2 > pop1 ?)
%t      <THEN>
%{4}    PUSH: (Integer Constant 4)
%e      <ELSE>
%{0}    PUSH: (Integer Constant 0)
%;      <END>
%e      <ELSE>
%{0}    PUSH: (Integer Constant 0)
%;      <END>
%e      <ELSE>
%G_u    PUSH: (Input PAPER SOURCE)
%;      <END>
%e      <ELSE>
%G_u    PUSH: (Input PAPER SOURCE)
%;      <END>
%;      POP -> ASCII String -> OUTPUT
%d

```

The calculation for the value of **Wu** begins by evaluating **%CO**, which pushes a **1** onto the stack if the **O** flag was specified on the command line, else it pushes a **0** onto the stack. The job submission command being used in this example did not use the **O** flag, so a **0** is pushed onto the stack. The next **%t**, finding a **0** on the stack, skips the next 23 lines of printer colon file escape sequences and evaluates the **%e** (else) clause on the fourth line from the bottom of the formatted form of the **Wu** attribute. The else clause is **%G\_u**, which pushes the value of **\_u**, the input paper source, onto the stack. The default value for **\_u** for this virtual printer is **1**, so a **1** is pushed onto the stack. The next **%;** terminates the original **%?**. The only remaining escape sequence, **%d**, pops the top value (a **1**) off the stack and returns it in ASCII format to the in-progress calculation of **wQ**.

The **1** returned to the in-progress calculation of **wQ** is the value of **Wu**, and is pushed onto the stack. The next **%{0}** pushes a **0** onto the stack. **%=** pops the top two values (a **0** and a **1**) off the stack and, checking them for equality, fails; a **0** is pushed onto the stack.

The next **%t** finds the **0** and so skips the **%Gs0** and instead evaluates the **%e** (else) clause. **Wu** (a **1**) is again pushed onto the stack. The **%{1}** pushes another **1** onto the stack. The **%=** again pops the top two values (two **1s**) off the stack and, checking them for equality, succeeds; a **1** is pushed onto the stack.

The next **%t** finds the **1** and so evaluates the **%Gs1**. The **s1** attribute is a number representing the paper size for paper tray 1, the upper paper tray, and its default value in this virtual printer definition is **1**. This **1** is pushed onto the stack. All but the very last of the remaining printer colon escape sequences in the evaluation of **wQ** are skipped. The **%d** pops the top value (a **1**) off the stack and returns it in ASCII format to the in-progress calculation of **wJ**.

The **1** returned to the in-progress calculation of **wJ** is the value of **\_Q**, and is pushed onto the stack. It is immediately popped back off the stack and stored in the internal variable **q**. **Wu**, already determined to be **1**, is again pushed onto the stack. **%{3}** pushes a **3** onto the stack, then the **%<** pops the top two values off the stack and checks to see if the second value popped is less than the first value popped. **1** is less than **3**, so a **1** is pushed onto the stack. The **%t** finds the **1** and so enters the if-then-else-then-else-then-else... sequence looking for an integer to pair with the paper size value calculated for **\_Q**.

The **%gq** fetches the stored value of **\_Q** from the internal variable **q**, and pushes it onto the stack. The **%{1}** pushes another **1** onto the stack. The **%=** pops the top two values (two **1s**) off the stack and, checking them for equality, succeeds; a **1** is pushed onto the stack. The **%t** finds the **1** and so evaluates the **%{2400}**, which pushes **2400** onto the stack. The calculation of **wJ** then falls through all but the last line of the remaining printer colon file escape sequences defining **wJ**. The last escape sequence, **%d**, pops the top value, **2400**, off the stack and returns it, in ASCII format, to the in-progress calculation of **wY**.

The **2400** returned to the in-progress calculation of **wY** is the value of **wJ**, and is pushed onto the stack. The **%GwK** in the else clause is skipped and the **%;** terminates the if-then-else sequence. The **%G\_v** fetches the line density (in lines per inch), **6**, and pushes it onto the stack. The **%\*** pops the top two values (a **6** and a **2400**) off the stack, multiplies them together, and pushes the result (**14400**) back onto the stack. The **{300}** pushes a **300** onto the stack. The **%/** pops the top two values (a **14400** and a **300**) off the stack, divides the second value popped off the stack by the first value popped off the stack, and pushes the result (**48**) onto the stack. The **%d** pops the top value (**48**) off the stack and returns it to the in-progress calculation of **wL**.

The **48** returned to the in-progress calculation of **wL** is the value of **\_l**. The value of **wL** was originally referenced in the determination of the value of the **ia** attribute, the input datastream pipeline for ASCII jobs. The number **48** replaces the **%IwL** in that determination, so the value of the **-!** flag to **pioformat** becomes **/usr/lib/lpd/pio/fmtrs/piof5202 -148**. The **-148** can be seen in the original diagnostic message from **piobe** that was the basis of this discussion; it is part of the **PIPELINE OF FILTERS** section of the mail sent by the **qdaemon** on behalf of **piobe**.

The calculation of the value associated with the **-w** flag to **piof5202** is described in ["Calculation of page width using printer colon file escape sequences"](#) on page 119.

The following "Calculation of Page Length" figure depicts the stack operations (as described above) used to obtain a final numeric value for page length in lines. The following numbered steps correspond to the numbers on the left side of the columns in the figure, and provide a step-by-step description of the evaluation of the printer colon file escape sequences defining page length, in lines, for this particular queue (**asc**), colon file, and command line.

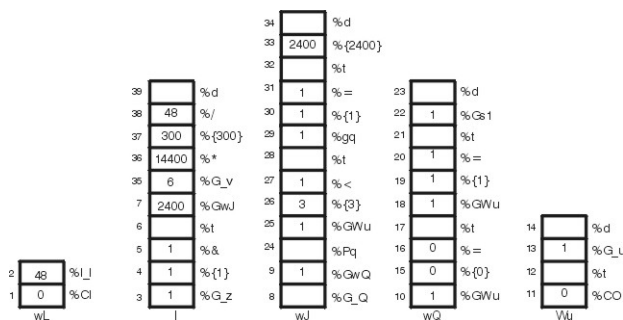

Figure 4. Calculation of Page Length

1. **%Cl** - Pushes a **0** onto the stack because the **l** flag was not used on the command line.
2. **%I\_l** - Calls for the evaluation of **\_l**.
3. **%G\_z** - Pushes a **1** onto the stack.
4. **{1}** - Pushes a **1** onto the stack.
5. **%&** - Pops the top two values (two **1s**) off the stack, performs a bitwise AND on the two values, and pushes the resultant **1** onto the stack.
6. **%t** - Pops the **1** off the stack and, because it is a TRUE (non-zero) value, calls for the evaluation of **%GwJ**. The stack labeled **\_l** is now empty.
7. **%GwJ** - Calls for the evaluation of **wJ**.
8. **%G\_Q** - Calls for the evaluation of **wQ**.
9. **%GwQ** - Calls for the evaluation of **%GWu**.
10. **%GWu** - Calls for the evaluation of **Wu**.
11. **%CO** - Pushes a **0** onto the stack because the **O** flag was not used on the command line.
12. **%t** - Pops the **0** off the stack and, because it is a FALSE (zero) value, calls for the evaluation of **%G\_u**. The stack labeled **Wu** is now empty.
13. **%G\_u** - Pushes a **1** onto the stack.
14. **%d** - Pops the **1** off the stack and returns it, in ASCII format, to the in-progress calculation of **wQ**.

15. **{0}** - Pushes a **0** onto the stack.
16. **=** - Pops the **0** and **1** off the stack, compares them for equality, and pushes the resultant **0** onto the stack.
17. **t** - Pops the **0** off the stack and, because it is a FALSE (zero) value, calls for the evaluation of **GwU**.
18. **GwU** - This value is already known, so a **1** is pushed onto the stack.
19. **{1}** - Pushes a **1** onto the stack.
20. **=** - Pops the two **1s** off the stack, compares them for equality, and pushes the resultant **1** onto the stack.
21. **t** - Pops the **1** off the stack and, because it is a TRUE (non-zero) values, calls for the evaluation of **Gs1**.
22. **Gs1** - Pushes a **1** onto the stack.
23. **d** - Pops the **1** off the stack and returns it, in ASCII format, to the in-progress calculation of **wJ**.
24. **Pq** - Pops the **1** off the stack and stores it in the internal variable **q**.
25. **GwU** - This value is already known, so a **1** is again pushed onto the stack.
26. **{3}** - Pushes a **3** onto the stack.
27. **<** - Pops the **3** and the **1** off the stack and, because **1** is less than **3**, pushes a **1** onto the stack.
28. **t** - Pops the **1** off the stack and, because it is a TRUE (non-zero) values, calls for the evaluation of **gq**.
29. **gq** - Pushes the value of the internal variable **q**, a **1**, onto the stack.
30. **{1}** - Pushes a **1** onto the stack.
31. **=** - Pops the two **1s** off the stack, compares them for equality, and pushes the resultant **1** onto the stack.
32. **t** - Pops the **1** off the stack and, because it is a TRUE (non-zero) values, calls for the evaluation of **{2400}**.
33. **{2400}** - Pushes a **2400** onto the stack.
34. **d** - Pops the **2400** off the stack and returns it, in ASCII format, to the in-progress calculation of **\_l**.
35. **G\_v** - Pushes a **6** onto the stack.
36. **\*** - Pops the **6** and the **2400** off the stack, multiplies them together, and pushes the resultant **14400** onto the stack.
37. **{300}** - Pushes a **300** onto the stack.
38. **/** - Pops the **300** and the **14400** off the stack, divides **14400** by **300**, and pushes the resultant **48** onto the stack.
39. **d** - Pops the **48** off the stack and returns it, in ASCII format, to the in-progress determination of **ia**, the input data stream pipeline for ASCII jobs.

### ***How the stack language describing page length works***

The IBM LaserPrinter 4029 Series Technical Reference contains a figure and a table that together describe the printable and unprintable areas on a page, and the paper and envelope dimensions, in pels, for standard paper and envelope sizes.

For example, the printable area on an 8.5 x 11 (width by length) inch page is 2400 x 3200 pels (width by length). Note that if the page is rotated either 90 or 270 degrees for landscape printing, the dimensions are swapped and become 3200 x 2400 pels (width by length).

The evaluation of **%IwL** begins by checking to see if the **l** flag was used on the command line; if it was, then there are no calculations to perform. The requested value will be used. (That is not a promise that it will work, just that it will be used.) If the **l** flag was not used on the command line, then **piobe** has to figure out how long the page is under the current job environment, as determined by other command line flags and by colon file defaults.

The first item checked in the evaluation of **\_l** (page length) is page orientation (**\_z**). As noted above, rotating the page by odd multiples of 90 degrees flips the page dimensions. Looking at the if-then-else statement that is the beginning of the definition of **wY**, it can be seen that the value of **\_z** is a switch that controls which of **wJ** and **wK** will be used for page length. If the page has a portrait orientation, then **wK** is length. If the page has a landscape orientation, then **wJ** is length. After the page length in pels is resolved, the remainder of the escape sequences in the definition of **wY** just take vertical line density into account while converting the number of pels to the number of lines.

The **wJ** attribute is selected because the page orientation is landscape. Thus far all that is known is that the dimensions have been flipped; what the dimensions actually are is still unknown. The evaluation of **wJ** begins by fetching the value (if any) of a command line usage of the **Q** flag, which is a printer-dependent value requesting a specific paper size. If the **Q** flag was used on the command line, then that value will be used to select the paper length in pels, otherwise a value for **Q** will be determined by evaluating **Wu**, which is a value for the paper source based on the attributes **\_O** (type of input paper handling) and **\_u** (input paper source). Note that **\_Q** is defined as **%IwQ**, whose definition begins with **%IWu**.

Because **Q** was not used on the command line, the evaluation of **Wu** determines that the **O** flag wasn't used either, and so executes the else clause in the outer if-then-else statement in the definition of **Wu**, returning the default colon file value of **\_u, 1**, to the evaluation of **wQ**.

Because this is as deep as the nesting of escape sequences goes for the evaluation of **\_l**, it is worth taking a closer look at the logic defining **Wu**. Keep in mind the definitions and legal values for **O**, **u**, and **Q**, which are:

- **O** - type of input paper handling - **1** (manual), **2** (continuous forms), **3** (sheet feed) - default is sheet feed.
- **u** - input paper source - **1** (primary), **2** (alternate), **3** (envelope) - default is primary.
- **Q** - paper size for input paper source - values are printer-dependent - defined by combination of **O** and **u**.

The escape sequences defining **Wu** say this:

- Case 1: If the **O** flag was not used on the command line, then return the colon file default value for **\_u**. For example, if the user did not specify a type of input paper handling, then return the input paper source (either from the command line or the default from the colon file) to the evaluation of **%IwQ**.
- Case 2: If the **O** flag was used on the command line but its value was not **1**, then return the colon file's default value for **\_u**. For example, if the user specified a type of input paper handling other than manual, then return the input paper source (either from the command line or the default from the colon file) to the evaluation of **%IwQ**.
- Case 3: If the **O** flag was used on the command line and its value was **1**, and the **u** flag was not used on the command line, then return a **O**. For example, if the user-specified manual paper handling but did not specify an input paper source, then return a **O** to the evaluation of **%IwQ**.
- Case 4: If the **O** flag was used on the command line and its value was **1**, and the **u** flag was used on the command line and its value was not greater than **2**, then return a **O**. For example, if the user specified manual paper handling and also specified either the primary or alternate input paper source, then return a **O** to the evaluation of **%IwQ**.
- Case 5: If the **O** flag was used on the command line and its value was **1**, and the **u** flag was used on the command line and its value was greater than **2**, then return a **4**. For example, if the user specified manual paper handling and also specified an input paper source of envelope, then return a **4** to the evaluation of **%IwQ**.

The definition of **wQ** is an if-then-else-then-else-then-else statement that repeatedly compares the value of **Wu** to the integers **0**, **1**, **2**, and **3**, looking for a match. The match selects the value of one of the attributes **s0**, **s1**, **s2**, **s3**, or **s4**, respectively (**s4** is selected when there is no other match). The items these attributes define are as follows:

- **s0** - paper size for manual paper feed
- **s1** - paper size for tray 1 (upper)
- **s2** - paper size for tray 2 (lower)
- **s3** - envelope size for envelope feeder

- **s4** - envelope size for manual envelope size

In the virtual printer definition for an ASCII queue on an IBM 4029 LaserPrinter, there are only two unique values for these five attributes: **s0**, **s1**, and **s2** are all **1**, while **s3** and **s4** are both **3**.

Looking back up the nested escape sequences, you can see that the definition of **wJ** is composed of an outer if-then-else statement. Both the if and the else pieces of this statement contain a chain of if-then-else-then-else... statements. The value of **Wu** (which is a value for paper source, based on **0** and **u**) determines whether the if or the else piece of the outer statement executes; if **Wu** is **1** or **2** (less than **3**), then the if piece executes; otherwise the else piece executes. It is in the final determination of **wJ** that the page length, in pels, is fixed.

The if piece of the outer if-then-else statement defining **wJ** selects a pel value from a range of non-envelope paper sizes; the else piece of the outer if-then-else statement selects a pel value from a range of envelope paper sizes. **Wu** controls which piece of the if-then-else statement executes but, after either the if or else piece has been chosen, it is the value of **Q** that causes a pel value to be selected. The five cases listed above work like this:

Case 1: Either the command line value of **u** or the default from the colon file (**1**, primary paper tray) is returned to the evaluation of **wQ**. The remaining escape sequences in the definition of **wQ** test the value of **Wu** and select the value of one of **s0**, **s1**, **s2**, **s3**, or **s4**. That value is in turn returned to the evaluation of **wJ**. If **u** is **1** or **2**, then **Q** will be **1** (non-envelope paper size). If **u** is **3**, then **Q** will be **3** (envelope paper size). When the evaluation of **wJ** is resumed, a **u** value of **1** or **2** will direct the process into the if piece of the outer if-then-else statement, and the **Q** value of **1** will select a page length of 2400 pels. A **u** value of **3** will direct the process into the else piece of the outer if-then-else statement, and the **Q** value of **3** will select an envelope page length of 1087 pels.

Case 2: Same as case 1.

Case 3: The user-specified manual paper handling on the command line but did not specify a paper source so **Wu** is assigned the value **0**, and that value is returned to the evaluation of **wQ**. The **0** will cause **wQ** to be assigned the value of **s0** (the paper size for manual paper feed, a **1**). When the evaluation of **wJ** is resumed, the **u** value of **0** will direct the process into the if piece of the outer if-then-else statement, and the **Q** value of **1** (**s0**) will select a page length of 2400 pels.

Case 4: The user specified manual paper handling on the command line and also used the **u** flag to specify either the primary or alternate paper source (but definitely not envelopes). As with case 3, a page length of 2400 pels will be chosen.

Case 5: The user-specified manual paper handling on the command line and also used the **u** flag to specify an envelope paper source so **Wu** is assigned the value **4**, and that value is returned to the evaluation of **wQ**. The **4** will cause **wQ** to be assigned the value of **s4** (the envelope size for manual envelope size, a **3**). When the evaluation of **wJ** is resumed, the **u** value of **4** will direct the process into the else piece of the outer if-then-else statement, and the **Q** value of **3** will select an envelope length of 1087 pels.

Our example is case 1: neither the **0** nor the **u** flags were used on the command line, so **Wu** is assigned a value of **1**, the default **\_u** value for this colon file. When the evaluation of **wQ** resumes, the match occurs on **s1**, and a **1** is returned to the evaluation of **wJ**. The **u** value of **1** direct the process into the if piece of the outer if-then-else statement, and the **Q** value of **1** selects a page length of 2400 pels. This value is returned to the evaluation of **\_l**.

The remaining printer colon file escape sequences defining **\_l** reason that if there are 2400 pels available (vertically), and if we want six lines per inch, and if there are 300 pels per inch (the resolution of the printer), then 48 lines can be printed on a page. The value **48** is returned to the evaluation of **ia**. That's basically where the **-l48** in the **PIPELINE OF FILTERS** came from.

### ***Calculation of page width using printer colon file escape sequences***

You can use printer colon file escape sequences to calculate page width.

The printer colon file for an ASCII queue on an IBM 4029 LaserPrinter defines page width, in characters, with the work attribute **ww**. As formatted by the **lsvirprt** (see “Virtual printer definitions” on page 105 for more information) command, **ww** is defined as follows:

Page Width In Characters, Using Width From Data Base (used in pipelines)  
 wW = %?%Cw%t%f!w%e%I\_w%;

```
%?          <IF>
%? %Cw      PUSH: (1 If -w Flag on Command Line; Otherwise 0)
%t          <THEN>
%t %f!w     For Each Flag x on Command Line: "-xArgument" ->
OUTPUT
%e          <ELSE>
%e %I_w     INCLUDE: (COLUMNS per page)
%;         <END>
```

The **%Cw** checks to see if the **w** flag was used on the command line; if it was, then a **1** is pushed onto the stack, else a **0** is pushed onto the stack. In this case, the **w** flag was not used on the command line so a **0** is pushed onto the stack. The **%t** checks for a true (non-zero) value on the stack and, not finding one, executes the **%e** (else) construct **%I\_w**.

The **\_w** attribute is defined as **%IwX**, shown below as formatted by the **lsvirprt** command.

```
Default Page Width (characters)
wX =
%?%G_z%{1}%&%t%GwK%e%GwJ%;%?%G_p%{17}%=%t%{171}%e%G_p%{10}%*%;%*%
?%G_w%t%{6000}%e%{3000}%;/%d
```

```
%?          <IF>
%? %G_z     PUSH: (Page ORIENTATION)
%? %{1}     PUSH: (Integer Constant 1)
%&         PUSH: (pop2 & pop1) -- Bitwise AND
%t          <THEN>
%t %GwK    PUSH: (Primary Page Length (-z 0) or Secondary
Page Width (-z
1), in pels)
%e          <ELSE>
%e %GwJ    PUSH: (Primary Page Width (-z 0) or Secondary Page
Length (-z
1), in pels)
%;         <END>
%?          <IF>
%? %G_p     PUSH: (PITCH (characters per inch))
%? %{17}    PUSH: (Integer Constant 17)
%=         PUSH: (pop2 = pop1 ?)
%t          <THEN>
%t %{171}  PUSH: (Integer Constant 171)
%e          <ELSE>
%e %G_p     PUSH: (PITCH (characters per inch))
%e %{10}    PUSH: (Integer Constant 10)
%*         PUSH: (pop2 * pop1)
%;         <END>
%*         PUSH: (pop2 * pop1)
%?          <IF>
%? %G_w     PUSH: (DOUBLE-WIDE print?)
%t          <THEN>
%t %{6000} PUSH: (Integer Constant 6000)
%e          <ELSE>
%e %{3000} PUSH: (Integer Constant 3000)
%;         <END>
%/         PUSH: (pop2 / pop1)
%d         POP -> ASCII String -> OUTPUT
```

The calculation of **\_w** begins by pushing the value of **\_z**, page orientation, onto the stack. The job submission command being used in this example, `qprt -a1 -Pasc -fp -p12 -scourier -C -N3 /etc/motd`, specifies a **z** value of **1**, so a **1** is pushed onto the stack. The **%{1}** pushes another **1** onto the stack, after which the **%&** pops the top two values (both **1**s) off the stack and performs a bitwise AND with the two values. The result of the bitwise AND, a **1**, is pushed onto the stack.

**Note:** The test is a bitwise AND instead of a simple test for equality because the legal values for the **z** flag are **0**, **1**, **2**, and **3**, corresponding to the legal number of 90 degree rotations that can be applied to a printed page.

The next **%t** finds a true (non-zero) value on the stack and so the then clause, **%GwK**, is resolved before any more work is done resolving **\_w**.

As formatted by **lsvirprt**, **wK** is defined as follows:

```
Primary Page Length (-z 0) or Secondary Page Width (-z 1), in pels
wK =
%G_Q%Pq?%GWu%{3}%<%t?%gq%{1}%=%t%{3200}%e%gq%{2}%=%t%{4100}%e%g
q%{3}%=%t%{2935}%e%gq%{4}%=%t%{3407}%e%{3050}%;%e?%gq%{1}%=%t%{2
150}%e%gq%{2}%=%t%{2562}%e%gq%{3}%=%t%{2750}%e%gq%{4}%=%t%{2498}%
e%gq%{5}%=%t%{2604}%e%{2852}%;%;%d
```

```
%G_Q      PUSH: (PAPER SIZE override for input paper source)
%Pq       POP -> Internal Variable q
%?        <IF>
  %GWu    PUSH: (Calculate value for paper source based on
_0 and _u.)
  %{3}    PUSH: (Integer Constant 3)
  %<      PUSH: (pop2 < pop1 ?)
  %t      <THEN>
    %?    <IF>
      %gq  PUSH: (Internal Variable q)
      %{1} PUSH: (Integer Constant 1)
      %=   PUSH: (pop2 = pop1 ?)
    %t    <THEN>
      %{3200} PUSH: (Integer Constant 3200)
    %e    <ELSE>
      %gq  PUSH: (Internal Variable q)
      %{2} PUSH: (Integer Constant 2)
      %=   PUSH: (pop2 = pop1 ?)
    %t    <THEN>
      %{4100} PUSH: (Integer Constant 4100)
    %e    <ELSE>
      %gq  PUSH: (Internal Variable q)
      %{3} PUSH: (Integer Constant 3)
      %=   PUSH: (pop2 = pop1 ?)
    %t    <THEN>
      %{2935} PUSH: (Integer Constant 2935)
    %e    <ELSE>
      %gq  PUSH: (Internal Variable q)
      %{4} PUSH: (Integer Constant 4)
      %=   PUSH: (pop2 = pop1 ?)
    %t    <THEN>
      %{3407} PUSH: (Integer Constant 3407)
    %e    <ELSE>
      %{3050} PUSH: (Integer Constant 3050)
  %;      <END>
  %e      <ELSE>
    %?    <IF>
      %gq  PUSH: (Internal Variable q)
      %{1} PUSH: (Integer Constant 1)
      %=   PUSH: (pop2 = pop1 ?)
    %t    <THEN>
      %{2150} PUSH: (Integer Constant 2150)
    %e    <ELSE>
      %gq  PUSH: (Internal Variable q)
      %{2} PUSH: (Integer Constant 2)
      %=   PUSH: (pop2 = pop1 ?)
    %t    <THEN>
      %{2562} PUSH: (Integer Constant 2562)
    %e    <ELSE>
      %gq  PUSH: (Internal Variable q)
      %{3} PUSH: (Integer Constant 3)
      %=   PUSH: (pop2 = pop1 ?)
    %t    <THEN>
      %{2750} PUSH: (Integer Constant 2750)
    %e    <ELSE>
      %gq  PUSH: (Internal Variable q)
      %{4} PUSH: (Integer Constant 4)
      %=   PUSH: (pop2 = pop1 ?)
    %t    <THEN>
      %{2498} PUSH: (Integer Constant 2498)
    %e    <ELSE>
      %gq  PUSH: (Internal Variable q)
      %{5} PUSH: (Integer Constant 5)
      %=   PUSH: (pop2 = pop1 ?)
    %t    <THEN>
      %{2604} PUSH: (Integer Constant 2604)
```

```

    %e      <ELSE>
           %{2852} PUSH: (Integer Constant 2852)
    %;      <END>
    %;      <END>
    %d      POP -> ASCII String -> OUTPUT

```

The calculation of **wK** begins by pushing the value of **\_Q**, the paper size override for the input paper source, onto the stack. The value of **\_Q** is defined as **%IwQ**. At this point in the calculation of **wK**, we are exactly where we were in the calculation of **wJ**, that is, trying to determine a value for **wQ** and **Wu**. Within the context of a single job submission command, the final values of **wQ** and **Wu** are not going to change just because a final value was requested from a different attribute calculation. Thus we'll use the previously calculated values of **1** for **wQ** and **1** for **Wu**.

The **1** returned to the in-progress calculation of **wK** is the value of **\_Q**, and is pushed onto the stack. It is immediately popped back off the stack and stored in the internal variable **q**. **Wu**, already determined to be **1**, is again pushed onto the stack. **{3}** pushes a **3** onto the stack, then the **%<** pops the top two values (a **3** and a **1**) off the stack and checks to see if the second value popped is less than the first value popped. **1** is less than **3** today, so a **1** is pushed onto stack. The **%t** find the **1** and so enters the if-then-else-then-else-then-else... sequence looking for an integer to pair with the paper size value calculated for **\_Q**.

The **%gq** fetches the stored value of **\_Q** from the internal variable **q**, and pushes it onto the stack. The **{1}** pushes a **1** onto the stack. The **%=** pops the top two values (two **1s**) off the stack and, checking them for equality, succeeds; a **1** is pushed onto the stack. The **%t** finds the **1** and so evaluates the **{3200}**, which pushes a **3200** onto the stack. The calculation of **wK** then falls through all but the last line of the remaining printer colon file escape sequences defining **wK**. The last escape sequence, **%d**, pops the top value, **3200**, off the stack and returns it, in ASCII format, to the in-progress calculation of **wX**.

The **3200** returned to the in-progress calculation of **wX** is the value of **wK**, and is pushed onto the stack. The **%GwJ** in the else clause is skipped and the **%;** terminates the if-then-else sequence. At this point in the calculation of **wJ**, the remainder of the attribute definition dealt with factors that affected page length (in lines), such as vertical line density. In the calculation of page width, however, we will be interested in pitch and in whether or not double-wide printing was selected.

The next escape sequence evaluated is **%G\_p**. This fetches the value of the **\_p** attribute, which defines the pitch in characters per inch for this queue. The default value for this queue is **10** but the command line being used in this example specified a pitch of **12** (**-p12**), so a **12** is pushed onto the stack. The **{17}** pushes a **17** onto the stack. The **%=** pops the top two values (a **17** and a **12**) off the stack and, checking them for equality, fails; a **0** is pushed onto the stack. The **%t** finds the **0** (a false value) and the following else clause is evaluated. **%G\_p** again pushes a **12** onto the stack. The **{10}** pushes a **10** onto the stack. The **%\*** pops the top two values (a **12** and a **10**) off the stack and multiplies them together; the resulting **120** is pushed onto the stack. The **%;** terminates this if-then-else sequence.

The following **%\*** pops the top two values (a **120** and a **3200**) off the stack and multiplies them together; the resulting **384000** is pushed onto the stack. The **%G\_W** fetches the value of **\_W** and pushes it onto the stack; **\_W** is a yes (**1**) or no (**0**) question concerning whether or not double-wide printing is needed. The default value is **0** and we did not override it on the command line, so a **0** is pushed onto the stack. The **%t** finds the **0** and so executes the else clause. The **{3000}** pushes a **3000** onto the stack. The **%;** terminates this if-then-else sequence. The following **%/** pops the top two values (a **3000** and a **384000**) off the stack and divides the second value popped by the first value popped; the resulting **128** is pushed onto the stack. The **%d** pops the top value, **128**, off the stack and returns it, in ASCII format, to the in-progress calculation of **wW**.

The **128** returned to the in-progress calculation of **wW** is the value of **\_w**. The value of **wW** was originally referenced in the determination of the value of the **ia** attribute, the input datastream pipeline for ASCII jobs. The number **128** replaces the **%IwW** in that determination, so the value of the **-!** flag to **pioformat** becomes **/usr/lib/lpd/pio/fmtrs/piof5202 -l48 -w128**. The **-w128** can be seen in the original diagnostic message from **pio** that was the basis of this discussion; it is part of the **PIPELINE OF FILTERS** section of the mail sent by the **qdaemon** on behalf of **pio**.

The following "Calculation of Page Width" figure depicts the stacks operations (as described above) used to obtain a final numeric value for page width in characters. The following numbered steps correspond to the numbers on the left side of the columns in the figure, and provide a step-by-step description of the evaluation of the printer colon file escape sequences defining page width, in characters, for this particular queue (**asc**), colon file, and command line.

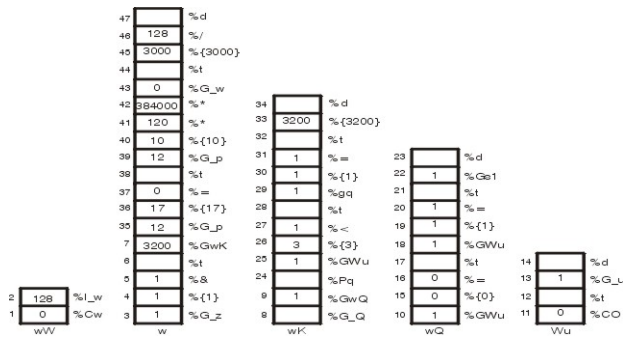

Figure 5. Calculation of Page Width

1. **%Cw** - Pushes a **0** onto the stack because the **w** flag was not used on the command line.
2. **%I\_w** - Calls for the evaluation of **\_w**.
3. **%G\_z** - Pushes a **1** onto the stack.
4. **%{1}** - Pushes a **1** onto the stack.
5. **%&** - Pops the top two values (two **1s**) off the stack, performs a bitwise AND on the two values, and pushes the resultant **1** onto the stack.
6. **%t** - Pops the **1** off the stack and, because it is a TRUE (non-zero) value, calls for the evaluation of **%GwK**.
7. **%GwK** - Calls for the evaluation of **wK**.
8. **%G\_Q** - Calls for the evaluation of **\_Q**.
9. **%GwQ** - Calls for the evaluation of **wQ**.
10. **%GWu** - Calls for the evaluation of **Wu**.
11. **%CO** - Pushes a **0** onto the stack because the **O** flag was not used on the command line.
12. **%t** - Pops the **0** off the stack and, because it is a FALSE (zero) value, calls for the evaluation of **%G\_u**. The stack labeled **Wu** is now empty.
13. **%G\_u** - Pushes a **1** onto the stack.
14. **%d** - Pops the **1** off the stack and returns it, in ASCII format, to the in-progress calculation of **wQ**.
15. **%{0}** - Pushes a **0** onto the stack.
16. **%=** - Pops the **0** and **1** off the stack, compares them for equality, and pushes the resultant **0** onto the stack.
17. **%t** - Pops the **0** off the stack and, because it is a FALSE (zero) value, calls for the evaluation of **%GWu**.
18. **%GWu** - This value is already known, so a **1** is pushed onto the stack.
19. **%{1}** - Pushes a **1** onto the stack.
20. **%=** - Pops the two **1s** off the stack, compares them for equality, and pushes the resultant **1** onto the stack.
21. **%t** - Pops the **1** off the stack and, because it is a TRUE (non-zero) values, calls for the evaluation of **%Gs1**.
22. **%Gs1** - Pushes a **1** onto the stack.
23. **%d** - Pops the **1** off the stack and returns it, in ASCII format, to the in-progress calculation of **wK**.
24. **%Pq** - Pops the **1** off the stack and stores it in the internal variable **q**.

25. **%GWu** - This value is already known, so a **1** is pushed onto the stack.
26. **{3}** - Pushes a **3** onto the stack.
27. **%<** - Pops the top two values off the stack (a **3** and a **1**) and, because **1** is less than **3**, pushes a **1** onto the stack.
28. **%t** - Pops the **1** off the stack and, because it is a TRUE (non-zero) value, calls for the evaluation of **%pq**.
29. **%pq** - Pushes the value of the internal variable **q**, a **1**, onto the stack.
30. **{1}** - Pushes a **1** onto the stack.
31. **%=** - Pops the top two values (two **1s**) off the stack, compares them for equality, and pushes the resultant **1** onto the stack.
32. **%t** - Pops the **1** off the stack and, because it is a TRUE (non-zero) value, calls for the evaluation of **{3200}**.
33. **{3200}** - Pushes a **3200** onto the stack.
34. **%d** - Pops the **3200** off the stack and returns it to the in-progress calculation of **\_w**.
35. **%G\_p** - Pushes a **12** onto the stack.
36. **{17}** - Pushes a **17** onto the stack.
37. **%=** - Pops the top two values (a **17** and a **12**) off the stack, compares them for equality, and pushes the resultant **0** onto the stack.
38. **%t** - Pops the **0** off the stack and, because it is a FALSE (zero) value, calls for the evaluation of **%G\_p**.
39. **%G\_p** - Pushes a **12** onto the stack.
40. **{10}** - Pushes a **10** onto the stack.
41. **%\*** - Pops the top two values (a **10** and a **12**) off the stack, multiplies them together, and pushes the resultant **120** onto the stack.
42. **%\*** - Pops the top two values (a **120** and a **3200**) off the stack, multiplies them together, and pushes the resultant **384000** onto the stack.
43. **%G\_w** - Pushes a **0** onto the stack.
44. **%t** - Pops the **0** off the stack and, because it is a FALSE (zero) value, calls for the evaluation of **{3000}**.
45. **{3000}** - Pushes a **3000** onto the stack.
46. **%/** - Pops the top two values (a **3000** and a **384000**) off the stack, divides the second value popped by the first value popped, and pushes the resultant **128** onto the stack.
47. **%d** - Pops the **128** off the stack and returns it, in ASCII format, to the in-progress calculation of **ia**, the input data stream pipeline for ASCII jobs.

### ***How the stack language describing page width works***

The IBM LaserPrinter 4029 Series technical reference contains a figure and a table that together describe the printable and unprintable areas on a page, and the paper and envelope dimensions, in pels, for standard paper and envelope sizes.

For example, the printable area on an 8.5 x 11 (width by length) inch page is 2400 x 3200 pels (width by length). Note that if the page is rotated either 90 or 270 degrees for landscape printing, the dimensions are swapped and become 3200 x 2400 pels (width by length).

The evaluation of **%Iww** begins by checking to see if the **w** flag was used on the command line; if it was, then there are no calculations to perform. The requested value will be used. (That is not a promise that it will work, just that it will be used.) If the **w** flag was not used on the command line, then **piobe** has to figure out how wide the page is under the current job environment, as determined by other command line flags and by colon file defaults.

The first item checked in the evaluation of **\_w** (page width) is page orientation (**\_z**). As noted above, rotating the page by odd multiples of 90 degrees flips the page dimensions. Looking at the if-then-else statement that is the beginning of the definition of **wK**, it can be seen that the value of **\_z** is a switch that

controls which of **wJ** and **wK** will be used for page width. If the page has a portrait orientation, then **wJ** is width. If the page has a landscape orientation, then **wK** is width. After the page width in pels is resolved, the remainder of the escape sequences in the definition of **wK** just take pitch and character-width (double wide or not) into account while converting the number of pels to the number of characters.

The **wK** attribute is selected because the page orientation is landscape. Thus far all that is known is that the dimensions have been flipped; what the dimensions actually are is still unknown. The evaluation of **wK** begins by fetching the value (if any) of a command line usage of the **Q** flag, which is a printer-dependent value requesting a specific paper size. If the **Q** flag was used on the command line, then that value will be used to select the paper width in pels, otherwise a value for **Q** will be determined by evaluating **Wu**, which is a value for the paper source based on the attributes **\_O** (type of input paper handling) and **\_u** (input paper source). Note that **\_Q** is defined as **%IwQ**, whose definition begins with **%IWu**.

Because **Q** was not used on the command line, the evaluation of **Wu** determines that the **Q** flag wasn't used either, and so executes the else clause in the outer if-then-else statement in the definition of **Wu**, returning the default colon file value of **\_u, 1**, to the evaluation of **wQ**.

Because this is as deep as the nesting of escape sequences goes for the evaluation of **\_w**, it is worth taking a closer look at the logic defining **Wu**. Keep in mind the definitions and legal values for **O**, **u**, and **Q**, which are:

- **O** - type of input paper handling - **1** (manual), **2** (continuous forms), **3** (sheet feed) - default is sheet feed.
- **u** - input paper source - **1** (primary), **2** (alternate), **3** (envelope) - default is primary.
- **Q** - paper size for input paper source - values are printer-dependent - defined by combination of **O** and **u**.

The escape sequences defining **Wu** say this:

- Case 1: If the **Q** flag was not used on the command line, then return the colon file default value for **\_u**. For example, if the user did not specify a type of input paper handling, then return the input paper source (either from the command line or the default from the colon file) to the evaluation of **%IwQ**.
- Case 2: If the **Q** flag was used on the command line but its value was not **1**, then return the colon file's default value for **\_u**. For example, if the user-specified a type of input paper handling other than manual, then return the input paper source (either from the command line or the default from the colon file) to the evaluation of **%IwQ**.
- Case 3: If the **Q** flag was used on the command line and its value was **1**, and the **u** flag was not used on the command line, then return a **0**. For example, if the user-specified manual paper handling but did not specify an input paper source, then return a **0** to the evaluation of **%IwQ**.
- Case 4: If the **Q** flag was used on the command line and its value was **1**, and the **u** flag was used on the command line and its value was not greater than **2**, then return a **0**. For example, if the user-specified manual paper handling and also specified either the primary or alternate input paper source, then return a **0** to the evaluation of **%IwQ**.
- Case 5: If the **Q** flag was used on the command line and its value was **1**, and the **u** flag was used on the command line and its value was greater than **2**, then return a **4**. For example, if the user-specified manual paper handling and also specified an input paper source of envelope, then return a **4** to the evaluation of **%IwQ**.

The definition of **wQ** is an if-then-else-then-else-then-else statement that repeatedly compares the value of **Wu** to the integers **0**, **1**, **2**, and **3**, looking for a match. The match selects the value of one of the attributes **s0**, **s1**, **s2**, **s3**, or **s4**, respectively (**s4** is selected when there is no other match). The items these attributes define are as follows:

- **s0** - paper size for manual paper feed
- **s1** - paper size for tray 1 (upper)
- **s2** - paper size for tray 2 (lower)
- **s3** - envelope size for envelope feeder
- **s4** - envelope size for manual envelope size

In the virtual printer definition for an ASCII queue on an IBM 4029 LaserPrinter, there are only two unique values for these five attributes: **s0**, **s1**, and **s2** are all **1**, while **s3** and **s4** are both **3**.

Looking back up the nested escape sequences, you can see that the definition of **wK** is composed of an outer if-then-else statement. Both the if and the else pieces of this statement contain a chain of if-then-else-then-else... statements. The value of **Wu** (which is a value for paper source, based on 0 and u) determines whether the if or the else piece of the outer statement executes; if **Wu** is **1** or **2** (less than **3**), then the if piece executes, otherwise the else piece executes. It is in the final determination of **wK** that the page width, in pels, is fixed.

Case 1: Either the command line value of u or the default from the colon file (**1**, primary paper tray) is returned to the evaluation of **wQ**. The remaining escape sequences in the definition of **wQ** test the value of **Wu** and select the value of one of **s0**, **s1**, **s2**, **s3**, or **s4**. That value is in turn returned to the evaluation of **wK**. If u is **1** or **2**, then Q will be **1** (non-envelope paper size). If u is **3**, then Q will be **3** (envelope paper size). When the evaluation of **wK** is resumed, a u value of **1** or **2** will direct the process into the if piece of the outer if-then-else statement, and the Q value of **1** will select a page width of 3200 pels. A u value of **3** will direct the process into the else piece of the outer if-then-else statement, and the Q value of **3** will select an envelope page width of 2750 pels.

Case 2: Same as case 1.

Case 3: The user-specified manual paper handling on the command line but did not specify a paper source so **Wu** is assigned the value **0**, and that value is returned to the evaluation of **wQ**. The **0** will cause **wQ** to be assigned the value of **s0** (the paper size for manual paper feed, a **1**). When the evaluation of **wK** is resumed, the u value of 0 will direct the process into the if piece of the outer if-then-else statement, and the Q value of **1** (**s0**) will select a page width of 3200 pels.

Case 4: The user-specified manual paper handling on the command line and also used the u flag to specify either the primary or alternate paper source (but definitely not envelopes). As with case 3, a page width of 3200 pels will be chosen.

Case 5: The user-specified manual paper handling on the command line and also used the u flag to specify an envelope paper source so **Wu** is assigned the value **4**, and that value is returned to the evaluation of **wQ**. The 4 will cause **wQ** to be assigned the value of **s4** (the envelope size for manual envelope size, a **3**). When the evaluation of **wK** is resumed, the u value of **4** will direct the process into the else piece of the outer if-then-else statement, and the Q value of **3** will select an envelope width of 2498 pels.

- Our example is case 1: neither the 0 nor the u flags were used on the command line, so **Wu** is assigned a value of **1**, the default **\_u** value for this colon file. When the evaluation of **wQ** resumes, the match occurs on **s1**, and a **1** is returned to the evaluation of **wK**. The u value of **1** direct the process into the if piece of the outer if-then-else statement, and the Q value of **1** selects a page width of 3200 pels. This value is returned to the evaluation of **\_w**.

The remaining printer colon file escape sequences defining **\_w** reason that if there are 3200 pels available (horizontally), and if we want 12 characters per inch, and if the resolution of printer is 300 pels per inch, then 128 characters can be printed across the page. Both the pitch and the printer resolution are multiplied by 10 to account for the possibility of a 17-pitch being specified. A 17-pitch is actually 17.1, so multiplying both the numerator and the denominator by 10 causes the .1 to be accounted for in the final calculation of page width. The value **128** is returned to the evaluation of **ia**. That's basically where the **-128** in the **PIPELINE OF FILTERS** came from.

### ***Spooler job header and trailer pages***

The pipelines for generating header and trailer pages are defined by the system administration attributes **sh** (header pages) and **st** (trailer pages).

The printing of header and trailer pages are separate processes from the spooler print jobs they accompany, even though they are not shown in the output of queue status queries.

### Header and trailer page pipelines

The **sh** attribute is used to define the pipeline for header and trailer pages.

Below is the **sh** attribute used to define the pipeline for header page generation and printing for an extended ASCII queue on an IBM 4029 LaserPrinter. The attribute is shown as formatted by the **lsvirprt** command. See [“Virtual printer definitions”](#) on page 105 for a further explanation.

```
Pipeline for Header Page
sh = %Ide/pioburst %F[H] %Idb/H.ascii | %Ide/pioformat
-@%Idd/%Imm -!%Idf/piof52
02 -L! -J! %IsH -u%IuH
```

```
%Ide          INCLUDE: (Directory Containing Miscellaneous
Modules)
'/pioburst '
%F[H]         If "-H] Argument" on Command Line, "-# Argument"
-> OUTPUT
|
%Idb          INCLUDE: (Directory Containing Header and Trailer
Text Files)
'/H.ascii | '
%Ide          INCLUDE: (Directory Containing Miscellaneous
Modules)
'/pioformat -@'
%Idd          INCLUDE: (Directory Containing Digested Data Base
Files)
'|
%Imm          INCLUDE: (File Name Of (Digested) Data Base; Init.
By
                "piodigest" (mt.md.mn.mq:mv))
' -!'
%Idf          INCLUDE: (Directory Containing Loadable Formatter
Routines)
'/piof5202 -L! -J! '
%IsH          INCLUDE: (FORMATTING FLAGS for header page)
' -u'
%IuH          INCLUDE: (Input PAPER TRAY for header page)
```

During spooler job processing, the value of the **sh** attribute is determined to be:

```
/usr/lib/lpd/pio/etc/pioburst /usr/lib/lpd/pio/burst/H.ascii |
/usr/lib/lpd/pio/etc/pioformat
-@/var/spool/lpd/pio/@local/ddi/ibm4029.asc.lp1.asc:lp1
-!/usr/lib/lpd/pio/fmtrs/piof5202 -L! -J! -u1
```

The **pioburst** command processes the header page template and pipes its output to the device-independent formatter, **pioformat**, which in turn loads the digested version of the colon file for this virtual printer (the argument to the **-@** flag) and the device-dependent formatter, **piof5202** (the argument to the **-!** flag). There are three flags to **piof5202**:

1. **-L!** - Long lines should not be wrapped.
2. **-J!** - The printer should be restored to the state it was in before the header page was printed.
3. **-u1** - The header page should be drawn from paper tray 1.

The value of the **st** definition is similar to the value of the **sh** definition.

### Custom header pages

The root user can create custom header pages for users by modifying the definition of the **sh** attribute.

Because the spooler processes have access to the environment of the user that submitted the job to the spooler, the root user can modify the portion of the **sh** attribute definition that specifies which header page template to process.

For example, **H.ascii** specifies which header page template should be processed and printed. It can be replaced with a user environment variable of your choice, such as **\$MYHEADER**, as shown below.

```
%Ide          INCLUDE: (Directory Containing Miscellaneous
Modules)
'/pioburst '
%F[H]         If "-H] Argument" on Command Line, "-# Argument"
```

```

-> OUTPUT
|
%Idb      INCLUDE: (Directory Containing Header and Trailer
Text Files)
|/$MYHEADER | '
%Ide      INCLUDE: (Directory Containing Miscellaneous
Modules)
|/pioformat -@'
%Idd      INCLUDE: (Directory Containing Digested Data Base
Files)
|/'
%Imm      INCLUDE: (File Name Of (Digested) Data Base; Init.
By
          "piodigest" (mt.md.mn.mq:mv))
| -!'
%Idf      INCLUDE: (Directory Containing Loadable Formatter
Routines)
|/piof5202 -L! -J! '
%IsH      INCLUDE: (FORMATTING FLAGS for header page)
| -u'
%IuH      INCLUDE: (Input PAPER TRAY for header page)

```

To enable the user **susan** to get custom header pages with this queue, the root user could use the following procedure:

- Type `cp /usr/lib/lpd/pio/burst/H.ascii /usr/lib/lpd/pio/burst/H.susan`
- Edit `H.susan` to Susan's taste in header pages.
- Set the environment variable **MYHEADER** in Susan's environment to **H.susan**. (For example, in the Korn shell, use `export MYHEADER=H.susan`).

When the user **susan** submits a job to this queue, the **sh** attribute's reference to a header page template will resolve to `/usr/lib/lpd/pio/burst/H.susan`, and the user **susan** will receive a custom header page. The problem with this scenario is that the environment variable **MYHEADER** must be defined for anyone that uses the queue associated with this virtual printer; otherwise, the virtual printer cannot resolve the reference to `/usr/lib/lpd/pio/burst/$MYHEADER`. An error will result if **\$MYHEADER** is undefined; the job might print, but the header page will be recyclable at best.

To avoid the problem of everyone that uses this queue having to have **MYHEADER** defined, you can integrate some shell code into the **sh** attribute definition to examine the user environment before the header page pipeline is created. One method for doing this is shown below.

```

Pipeline for Header Page
sh = { if test X"$MYHEADER" = X ; then %Ide/pioburst %F[H]
%Idb/H.ascii | %Ide/pioformat -@%Idd/%Imm -!%Idf/piof5202 -L! -J!
%IsH -u%IuH; else %Ide/pioburst %F[H] %Idb/$MYHEADER |
%Ide/pioformat -@%Idd/%Imm -!%Idf/piof5202 -L! -J! %IsH -u%IuH;
fi; }

```

```

' { if test X"$MYHEADER" = X ; then '
%Ide      INCLUDE: (Directory Containing Miscellaneous
Modules)
|/pioburst '
%F[H]     If "-H] Argument" on Command Line, "-# Argument"
-> OUTPUT
|
%Idb      INCLUDE: (Directory Containing Header and Trailer
Text Files)
|/H.ascii | '
%Ide      INCLUDE: (Directory Containing Miscellaneous
Modules)
|/pioformat -@'
%Idd      INCLUDE: (Directory Containing Digested Data Base
Files)
|/'
%Imm      INCLUDE: (File Name Of (Digested) Data Base; Init.
By
          "piodigest" (mt.md.mn.mq:mv))
| -!'
%Idf      INCLUDE: (Directory Containing Loadable Formatter
Routines)
|/piof5202 -L! -J! '
%IsH      INCLUDE: (FORMATTING FLAGS for header page)
| -u'

```

```

%IuH      INCLUDE: (Input PAPER TRAY for header page)
'; else '
%Ide      INCLUDE: (Directory Containing Miscellaneous
Modules)
'/pioburst '
%F[H]     If "-H] Argument" on Command Line, "-# Argument"
-> OUTPUT
'
%Idb      INCLUDE: (Directory Containing Header and Trailer
Text Files)
'/$MYHEADER | '
%Ide      INCLUDE: (Directory Containing Miscellaneous
Modules)
'/pioformat -@'
%Idd      INCLUDE: (Directory Containing Digested Data Base
Files)
'/'
%Imm      INCLUDE: (File Name Of (Digested) Data Base; Init.
By
' -!'
%Idf      INCLUDE: (Directory Containing Loadable Formatter
Routines)
'/piof5202 -L! -J! '
%IsH     INCLUDE: (FORMATTING FLAGS for header page)
' -u'
%IuH     INCLUDE: (Input PAPER TRAY for header page)
'; fi; } '

```

The original **st** definition is repeated twice in the new **st** definition. The shell code checks to see if **MYHEADER** is defined; if **MYHEADER** is not defined, then the header page template `H.ascii` is used, else the header page template **\$MYHEADER** is used.

### **Modification of the *mo* virtual printer attribute**

All virtual printer definitions contain an attribute named **mo**.

The **mo** attribute specifies the command string to invoke the device driver interface program. The device driver interface program is the last process in the input data stream processing pipeline and, in the case of local spooler queues with **pio** as the backend, is usually **pioout**. It is named the device driver interface program because, as the last process in the pipeline, it generally opens the device driver for writing and then writes the processed input data stream to the device driver. See [“Datastream flow for common print jobs”](#) on page 50 for additional information.

The design of the base operating system spooler allows the root user to replace the pieces of the input data stream of the processing pipeline with user-written code. An example of redefining the **mo** attribute, whose default value is the full path of **pioout**, to the full path of a user-written delivery program is covered. See [“Backend processing”](#) on page 49 for more information.

#### *Unsupported IP-addressable terminal servers*

You can use the formatter filters's ability to manipulate the printer's mode and the input data stream to create a queue on a print server to which users can submit ASCII jobs.

Suppose that you have an IP-addressable terminal server attached to your Ethernet network. The terminal server has some number of asynchronous ports to which you can attach ASCII terminals, modems, printers, or other asynchronous devices. Further suppose that the terminal server vendor supplied you with a program, named **ts\_print**, that has the following properties:

- It will read from standard input.
- It accepts a **-A** flag to specify an IP address.
- It accepts a **-P** flag to specify a port number.

To turn this into a specific example, suppose that you have an IBM 4029 LaserPrinter that you want to attach to port 11 on the terminal server and that the terminal server's IP address is 9.19.129.101. Your goal is have a queue on a print server to which users can submit ASCII jobs and have them printed on the 4029 on the terminal server. Though you can use **ts\_print** from the command line, you would prefer to make use of the formatter filter's ability to perform extensive manipulation of both the printer's mode and the input data stream. Providing true serial access to the printer is also a goal.

There is more than one way to accomplish this goal. The easiest way involves making a local ASCII queue on a normal file, instead of on a character-special file in the `/dev` directory. After you create the queue and the associated virtual printer, you can modify the virtual printer to use **ts\_print**.

To begin the queue creation process, enter the SMIT fast path **smit mkquedev**. A menu similar to the following displays:

```
Add a Print Queue
```

```
Move cursor to desired item and press Enter. Use arrow keys to scroll.
```

#	ATTACHMENT TYPE	DESCRIPTION
	local	Printer Attached to Local Host
	remote	Printer Attached to Remote Host
	ascii	Printer Attached to ASCII Terminal
	hpJetDirect	Network Printer (HP JetDirect)
	file	File (in /dev directory)
	other	User Defined Backend

Choose the **file** option, then choose a printer type. After you choose the IBM 4029 LaserPrinter (or whatever is correct for your situation), provide the name of an existing file in the `/dev` directory. This is the file to which processed jobs submitted to the queue you are creating are written. The name of the file can be anything that adheres to the base operating system naming conventions. A reasonable action is to create a file just for the purpose of being the target of file queues. For example, the root user can issue the command `touch /dev/lxx` to create a file named `lxx` in the `/dev` directory.

After you provide the name of a file in the `/dev` directory, choose a queue name for each input data stream supported by the printer type you selected earlier. In this example, suppose the name **asc** was chosen for an ASCII queue. An entry like the following would appear in `/etc/qconfig`:

```
asc:
    device = lxx
lxx:
    file = /dev/lxx
    header = never
    trailer = never
    access = both
    backend = /usr/lib/lpd/piobe
```

Any print job submitted to the spooler queue **asc** is processed by the pipeline set up by **piobe**. The processed data stream is written to `/dev/lxx`. This is not what you want to happen. Because the goal is to have **ts\_print** write the output to port 11 on the terminal server, there should in fact not even be a file associated with this queue. To this end, edit the new stanza pair in `/etc/qconfig` and change the value of the **file** parameter to **FALSE**, like this:

```
asc:
    device = lxx
lxx:
    file = FALSE
    header = never
    trailer = never
    access = both
    backend = /usr/lib/lpd/piobe
```

If you use this queue in this state, you do not see anything written to a file or printed anywhere, except maybe for error messages. When the **qdaemon** sets the backend, **piobe**, into execution, it passes **piobe** an open file descriptor based on the value of the **file** parameter in `/etc/qconfig`. When that value is set to **FALSE**, the file descriptor is not passed. The eventual recipient and user of the file descriptor is whatever program is pointed to by the **mo** attribute. The default program pointed to by the **mo** attribute is **pioout** and, when jobs are put on the queue when it is in this state, **pioout** will not have a valid value for `stdout`, and the processed job will simply vanish.

At this point, you can use **lsvirprt** to select the **asc** virtual printer definition for modification (see [“Virtual printer definitions”](#) on page 105 for more information). A prompt similar to the following displays:

```
To LIST attributes, enter AttributeName1 ... (* for all attributes)
To CHANGE an attribute value, enter AttributeName=NewValue
To FORMAT and EDIT an attribute value, enter AttributeName~v
To EDIT the attribute file, enter ~v
To terminate, press Enter:
```

Assuming the **ts\_print** program was installed in `/usr/bin`, enter the following at the prompt:

```
mo=/usr/bin/ts_print -A 9.19.129.101 -P 11
```

Jobs submitted to the **asc** queue will now be processed as if they were local jobs but, when the end of the pipeline is reached, the **ts\_print** program will deliver the output data stream to port 11 on the terminal server instead of **pioout** delivering it to a device driver.

In general, the **mo** attribute in the virtual printer definition for a queue with **pioibe** as the backend can be redefined to deliver a processed data stream to any file or device the user chooses, provided the you can write the code to do it.

## Filters

Virtual printer definitions contain predefined and *open* (undefined) filter attributes.

For example, an AIX Version 4 ASCII queue on an IBM 4029 LaserPrinter offers the following filter attributes:

- f1, f2, f3, f4, and f5 - open, user-defined filters
- fb - bidi filter for Hebrew/Arabic.
- fc - cifplot filter
- fd - TeX (DVI) filter
- ff - FORTRAN filter
- fg - plot filter
- fl - passthru filter
- fn - ditroff filter
- fp - **pr** filter
- fv Raster image filter
- fc, fd, ff, fg, fl, fn ,ft, fv - open, user-defined filters
- fp - **pr** filter

Filters are the first programs in the input data stream processing **pipeline** set up by the **pioibe** command that have an opportunity to selectively manipulate the data stream. A particular filter can be selected from the command line on a per-job basis, or permanently selected by modifying the virtual printer definition.

The **qprt** command uses the `-f` flag to select a particular filter on a per-job basis. The argument to the `-f` flag is the second letter of the two letters that name the filter attribute in the virtual printer definition. For example, to select the **pr** filter for a job on an ASCII queue named **asc** on an IBM 4029 LaserPrinter, you could issue this command:

```
qprt -Pasc -fp /etc/motd
```

The filter attribute that selects the **pr** filter is named **fp**, so the argument to the `-f` flag is just **p**, the second letter.

To permanently select the **pr** filter, use the **lsvirprt** command to edit the virtual printer definition and set the value of the `_f` attribute to **p**. The `_f` attribute selects a filter that will be used to pre-process any job submitted to the queue associated with this virtual printer definition.

Because **lp**, **lpr**, and **qprt** are all just front ends to the **enq** command, the true entry point to the spooler, you would suppose that **enq** must support the `-f` flag. If you issue the **enq** command with the `-f` flag, however, you will receive an error message; **enq** does not support the `-f` flag. This is a

situation where the previously described technique (see [“Spooler data flow \(enq command\)”](#) on page 48) of mounting `/bin/echo` over `/bin/enq` proves useful.

The root user can issue these commands from a shell prompt:

1. `mount /bin/echo /bin/enq`
2. `qprt -Pasc -fp /etc/motd`
3. `umount /bin/enq`

After the second command is issued, the following appears in the display element defined by your TERM environment variable:

```
-P asc -o -f -o p /etc/motd
```

These are the arguments **qprt** tried to pass to **enq**. You see them because **qprt** found **echo** instead of **enq**. The following command is equivalent to the command shown in step 2 above:

```
enq -P asc -o -f -o p /etc/motd
```

The `-o` option specifies that flags specific to the backend should be passed to the backend. The `-o` option can be thought of as a free pass through the syntax checking that occurs before the **enq** command builds a job description file and notifies the **qdaemon** of the existence of a new job.

Suppose that you want to set up a queue that will print a range of lines from an ASCII file. For example, suppose you read `/usr/lpp/bos/README` and find 35 lines that you want to print so you can fax them to someone or tack them to your wall for reference. You could edit `/etc/qconfig` and add the following lines:

```
partial:
  device = partial
partial:
  file = FALSE
  backend = /usr/bin/partial
```

The file `/usr/bin/partial` could be a shell script with ownership of `root.printq` and with permissions of 755. Its contents could be as follows:

```
#!/bin/ksh
BEGIN=$1
END=$2
let DIFF=END-BEGIN+1
FILE=$3
/usr/bin/head -${END} ${FILE} | tail -${DIFF} | /usr/bin/qprt -Pasc
```

If you wanted to print lines 189 through 223 of `/usr/lpp/bos/README`, you could use the **partial** queue as follows:

```
qprt -Ppartial -o 189 -o 223 /usr/lpp/bos/README
```

When the backend executes, **BEGIN** is assigned 189, **END** is assigned 223, and **DIFF** is assigned 35, which is the number of chosen lines. **FILE** is assigned `/usr/lpp/bos/README`. The **head** command truncates `/usr/lpp/bos/README` immediately after the last requested line. The output is piped to the **tail** command, which selects the last 35 lines of the truncated file and pipes them to the **qprt** command, which will take input from stdin. The **qprt** command submits the lines to the queue named **asc**.

#### *Filter for mapping linefeeds to carriage returns and linefeeds*

Many users have written or purchased applications that prepare data streams to fill in the blanks on pre-printed checks, invoices, bills-of-lading, or other forms. Printing these data streams requires precise control of the physical printer.

It is often the case that the job processing pipeline created by **pio** inserts or deletes enough data from the original data stream that the output data no longer falls at the proper position on the pre-printed form.

The root user can frequently use the **lsvirprt** command to set the value of the **\_d** attribute in the virtual printer definition to **p**. On an ASCII queue on an IBM 4029 LaserPrinter, this would cause **pio** to select the **ip** pipeline to process the job. The **ip** pipeline is for passthru printing, which means the formatter filters uses the `passthru()` routine to simply pass the input data stream through to the printer without modification.

This frequently removes all the printer control problems that existed, but adds one new one. When the formatter filter operates in passthru mode, the mapping of linefeeds to carriage returns and linefeeds is disabled. The forms still do not print correctly.

Suppose that the application does not allow the insertion of carriage returns into the data stream, you can fix this problem with a simple filter, as follows:

```
#include <stdio.h>

main(int argc, char **argv)
{
    int ch ;

    while (EOF != (ch = fgetc(stdin)))
    {
        switch (ch)
        {
            case 10: fputc(ch,stdout) ;
                    fputc(0x0D,stdout) ;
                    break ;
            default: fputc(ch,stdout) ;
                    break ;
        }
    }
}
```

Compile your program and name it **cr\_mapper**. and install it in an accessible location, such as `/usr/lib/lpd`. Assign it ownership of **root.printq** and permissions **555**.

Assuming you have an ASCII queue named **asc** on an IBM 4029 LaserPrinter, you can use **lsvirprt** to select the **asc** queue and then format the **f1** filter attribute. You should see something like the following:

```
User defined filter 1
f1 =
```

As the **f1** attribute has a null default value, the definition is sparse.

Edit the **f1** attribute so its definition appears as follows:

```
User defined filter 1
f1 =
    '/usr/lib/lpd/cr_mapper'
```

When you save the new definition of **f1**, you can again format it with **lsvirprt**; you should see something like the following:

```
User defined filter 1
f1 = /usr/lib/lpd/cr_mapper
    '/usr/lib/lpd/cr_mapper'
```

The **f1** filter can now be used from the command line by using commands such as:

```
qprt -Pasc -f1 filename
```

```
enq -Pasc -o -f -o 1 filename
```

If the **\_d** attribute was not set to **p**, the **-dp** flag and argument would have to be added to the commands.

```
qprt -Pasc -dp -f1 filename
```

```
enq -Pasc -o -d -o p -o -f -o 1 filename
```

The **cr\_mapper** program reads characters from **stdin** and writes them to **stdout**. Whenever it reads and writes a linefeed (a hex A, or decimal 10), it writes out a carriage return (a hex D).

### ***/etc/qconfig File***

The `/etc/qconfig` configuration file can be edited with your text editor of choice.

There are unenforced rules concerning when you can and cannot edit the `/etc/qconfig` file without halting or otherwise corrupting the operation of the spooler.

The `/etc/qconfig` file should never be edited when jobs are processing. This is especially true when your system has a large number (greater than 25) of printers that are generally pretty busy. When the **qdaemon** receives notification from **enq** that a new Job Description File (JDF) exists, the **qdaemon** examines the dates on both `/etc/qconfig` and `/etc/qconfig.bin`, the binary version of `/etc/qconfig`. If `/etc/qconfig` is younger than `/etc/qconfig.bin`, the **qdaemon** does not accept any new jobs, including the one that caused it to examine the aforementioned files, until all currently running jobs have finished processing. When the jobs have finished processing, the **qdaemon** creates a new version of `/etc/qconfig.bin`.

If you cause the **qdaemon** to go into this state while jobs are processing, it is possible for the spooler to hang. If you modify `/etc/qconfig` under these conditions, and if any printers are still generating output, your best option is to leave the system alone and see if it comes back to life after all the jobs have finished processing. If zero printers are producing output or the spooler appears to be hung, see [“Cleaning up and starting over”](#) on page 272.

**Note:** Do not cause a change to `/etc/qconfig` while jobs are processing. Aside from editing `/etc/qconfig` and writing a new version of the file to disk with a text editor, you can cause the same effect by using the **smit** command to change a queue property or a parameter value.

### **Creation of queues with a text editor**

The root user can edit `/etc/qconfig` and define queues with a text editor. One situation where this should not be done is when the backend for the spooler queue is **piobe**. Queues that use **piobe** as backend must have an associated virtual printer definition. In this situation, the root user should use the **smit** command to create the queue. Using the **smit** command will run several programs that create the virtual printer definition.

## **Transparent printing**

---

Most terminals have an auxiliary port that can be connected to a serial printer. These terminals support two print modes, Auxiliary and Transparent.

If both print modes are OFF, data received by the terminal is simply displayed on the screen. With Auxiliary print mode ON, data received by the terminal is displayed on the screen and is also transmitted to the printer. With Transparent Print Mode ON, the terminal transmits data received directly to the printer, without displaying it on the screen.

Transparent printing allows you to use your terminal in a normal manner, while information is also being sent over the same serial connection from the host to the printer connected to the terminal's auxiliary printer port. This is transparent printing. The transparent printing software determines whether packets of data are bound for the screen or for the printer, and precedes data bound for the printer with the Transparent Print Mode ON command, and follows it with the Transparent Print Mode OFF command.

Data for the terminal screen has the highest priority, and data is sent to the printer only when there is a break in information being sent to the screen. If continuous data is being transmitted to the terminal device, nothing gets sent to the printer.

Whenever an auxiliary printer port is used, flow control to the printer becomes an issue. If the printer falls behind and invokes flow control, output to both the printer and the terminal is stopped. The transparent print feature provides three parameters, accessible through SMIT, to limit printer output and avoid this situation.

The SMIT Transparent Print Maximum Characters per Second parameter limits the maximum printer port character-per-second data rate. This number should be set to the minimum character rate the printer can sustain in typical use.

The SMIT Transparent Print Maximum Character Packet Size parameter limits the number of characters queued to the printer ahead of terminal output. Lower numbers increase system overhead, higher numbers result in keystroke echo delays. Specify a value of **50** for 9600 baud.

The SMIT Transparent Print Printer Buffer Size parameter should be set to a value just below the printer's buffer size. After a period of inactivity, the driver will burst up to this many characters to the printer to fill the print buffer before slowing to the maxcps rate.

The printer on/off strings are also set using SMIT. A cable must be connected between the auxiliary port of the terminal and the printer. The baud rate on the terminal auxiliary port and the printer must be the same, and the printer and the auxiliary port of the terminal must use the same handshaking mode. The auxiliary port must also be enabled. If your terminal is not one of those directly supported, you must know the escape sequence of your terminal.

See your terminal and printer manuals for connection information, escape codes, and to see what handshaking modes are supported (for example, busy/ready or RTS/CTS). Printer devices (**xtty1**, for example) must not be in either the `/etc/inittab` or `/etc/ttys` files and must not be enabled.

For information about activating transparent printing, see: "[Configuring a Terminal-Attached Printer](#)".

## Configuring a printer or plotter connected to a RAN

A procedure for defining and configuring a printer or plotter attached to a 128-port asynchronous adapter RAN is provided.

1. You must have root user authority.
2. A 128-port asynchronous adapter must be installed, defined, and available.
3. At least one RAN must be connected.
4. Set the RAN's node ID.

**Note:** To work properly with the Print Spooler Subsystem, serial printers and plotters should be attached to the RAN using 8- or 10-pin RJ-45 cabling.

The procedure is as follows:

1. To add a printer/plotter device to a 128-port RAN, use the **smit pdp** fast path to access the **Printer/Plotter Devices** menu.
2. Select **Add a Printer/Plotter**.
3. Select the appropriate printer device from the list of printer and plotter types shown on the screen and press the Enter key. For this example, the following selection was made:

```
osp      Other serial printer
```

4. Select **rs232** or **RS-422**, as appropriate for the RAN type.
5. Make a selection from the available RANs displayed on the screen. If no RANs are displayed or if they are shown in a defined state, check the RAN configuration, cabling, and setup again. For this example, the following selection was made:

```
sa4 Available 00-03-21 16-Port RAN EIA-232 for 128-Port Adapter
```

6. In the displayed dialog fields, you can add or change the desired printer/plotter device attributes.
7. When you have finished, select **Do**.

## Configuring terminal-attached printers

You can configure terminal-attached printers.

1. The 128-port adapter is properly configured and operational.

2. The 3151 display is attached to the 128-port adapter and is operational.
3. The ASCII display is attached to the 128-port adapter and is operational.
4. Printer software for terminal-attached printing is installed.

### Hardware requirements

- IBM 8- or 128-port adapter
- ASCII display (an IBM 3151 display is used for this hardware)
- Serial printer
- EIA 232 serial cabling and gender changers

Many of the ASCII terminals used today have an auxiliary serial or parallel port on which to connect a printer device. Connections of this type offer administrators a means of sharing valuable computer resources and increasing user productivity and efficiency by moving the printers as close as possible to the users. This section describes the hardware requirements and prerequisites necessary to configure this type of terminal-attached printer in this operating system environment.

### Setting up the hardware for terminal-attached printers

There are several steps you must perform when setting up hardware for terminal-attached printers.

Before adding the printer to your system, perform the following steps:

1. Connect the serial printer to the auxiliary port of your terminal using an EIA 232 modem cable (IBM cable D). A null-modem cable is *not* needed on the AUX port of an IBM 3151 terminal.
2. Make note of the following settings for your printer: line speed, word length (or bits-per-character), parity (odd, even, no, space, mark), and the number of stop bits.

### Configuring the auxiliary port for terminal-attached printers

You can configure the auxiliary port for terminal-attached printers.

On the IBM 3151 terminal, perform the following steps:

1. Turn on your terminal while simultaneously pressing the Ctrl and Setup keys. The **SETUP** menu is then displayed on the 3151 screen.
2. Use the Send key to move between menu screens until the **KEYBOARD/PRINTER** option is displayed. Fill in the **PRINTER** options with the printer settings you noted previously.
3. Press the Send key until the **FUNCTION** screen is displayed. Select the **Save** option and press the Spacebar to save the configuration.

### Adding the print queue for terminal-attached printers

You can add a print queue for terminal-attached printers.

At this point, you have physically attached the printer to the terminal and configured its auxiliary port with the correct printer settings. The following procedures describe the creation of a local print queue on the host that will access the terminal-attached printer device.

1. Log on as root or as a member of the **printq** admin group.
2. Use the **smi:t mkpq** fast path to access the **Add a Print Queue** menu.

**Note:** The screen content may vary depending on the printer software installed on the host.

3. Select the **ascii** option, which takes you to the **Printer Type** screen.
4. Select the appropriate printer manufacturer or **Other**. For this example, we selected **IBM**. An additional **Printer Type** screen is displayed.
5. Select the appropriate printer model. For this example, we selected **ibm2380-2**. The **TTY Name** screen is displayed.
6. Select the tty for the terminal that has your printer attached. For this example, we selected **tty0**. The **Add a Print Queue** screen is then displayed.

7. Enter a descriptive name for the terminal-attached print queue (for example, `tty0asc`) in the **Name of new PRINT QUEUE to add** field, and press the Return key. The print queue will NOT be created.

## Testing a terminal-attached printer

You can test a terminal-attached printer to verify that the printer is functioning properly.

1. To verify that the printer is functioning properly, issue an **lpstat** command to list all available print queues on the system. Output similar to the following is displayed:

```
# lpstat
Queue      Dev      Status   Job Files   User    PP %   Blks   Cp   Rnk
-----
4019g1     lp0      READY
4019ps     lp1      READY
tty0asc    tty0     READY
```

2. Use the following **enq** command to send an ASCII file to the printer:

```
enq -P tty0asc /etc/qconfig
```

The file should be printed without altering the display or functionality of the terminal.

## Printer-specific information

---

The format and content of the header and trailer pages can be customized by editing the files containing the prototype text.

The files that contain the prototype text are in the `/usr/lib/lpd/pio/burst` directory. The file names are in the format `X.yyy`, where `X` is either **H** to indicate header pages or **T** to indicate trailer pages. `yyy` indicates the type of data stream: **ascii** for ASCII, **ps** for PostScript, or **gl** for plotter emulation. For example, the file named `H.ascii` is the prototype text for header pages to be printed in ASCII, and `T.ps` is the prototype text for trailer pages to be printed in PostScript. The escape sequences used in the text files begin with the **%** (percent) character and are described with the **pioburst** command. See the **pioburst** command for more information.

The following sections give you information specific to certain printers that you might need to configure and set up your printer and queue systems:

### IBM Personal Printer II Models 2380, 2381, 2390, 2391, 2380-2, 2381-2, 2390-2, 2391-2

Product specific information for each printer and queue system is provided.

Printers purchased in Greece or Turkey have the Greek or Turkish code pages available with the printer. To print Greek or Turkish characters, you must notify the system that the code pages are available. To do this:

1. As the root user, enter `smit chpq`.
2. Select the appropriate print queue and select **Printer Setup** on the **Change/Show Characteristics** menu.
3. Change **COUNTRY** to the appropriate country selection.

### IBM 3812 Model 2 Page Printer

Product specific information for the printer and queue system is provided.

The system assumes that a font diskette, Feature #3155, is in the printer's diskette drive. For the support of Greek or Turkish characters, the system assumes that a Language Group 3 font diskette is in the drive.

Fonts are loaded into printer memory from a font diskette inside the printer. The system maintains a record of which fonts have been loaded, and whether the fonts in memory may have been corrupted by a

print job and therefore need reloading from diskette. If the printer is turned off and then turned back on, run the **sp1p** command with the **-F !** flag and the device name. This notifies the system that the fonts need to be loaded into the printer's memory.

The 3812 Model 2 Page Printer can print on paper other than the default 8-1/2 by 11 inch size. You can change the paper size using SMIT. To change paper size for a single print job, specify the **-Q** flag with the **qprt** command.

If you need support for Greek or Turkish characters, complete the following steps:

1. You must have a Language Group 3 font diskette installed in the printer.
2. As the root user, enter `smit chpq`.
3. Select the appropriate print queue and select **Printer Setup** on the **Change/Show Characteristics** menu. For the font diskette, specify:
  - CP851 to print Greek characters.
  - CP853 to print Turkish characters.

## IBM 3816 Page Printer

Product specific information for the printer and queue system is provided.

The system assumes that a font diskette, Feature #7652, is in the printer's diskette drive.

Fonts are loaded into printer memory from a font diskette inside the printer. The system maintains a record of which fonts have been loaded, and whether the fonts in memory may have been corrupted by a print job and therefore need reloading from diskette. If the printer is turned off and then turned back on, run the **sp1p** command with the **-F !** flag and the device name. This notifies the system that the fonts need to be loaded into the printer's memory.

The 3816 Page Printer can print on paper other than the default 8-1/2 by 11 inch size. The paper size can be changed using SMIT. To change paper size for a single print job, specify the **-Q** flag with the **qprt** command.

## IBM 4019 LaserPrinter and 4029 LaserPrinter

Product specific information for each printer and queue is provided.

The system selects the IBM ASCII or PCL emulation data stream without manual intervention.

The LaserPrinter can print on paper other than the default 8-1/2 by 11 inch size and on envelopes other than the default #10 envelope. The paper or envelope size can be changed using SMIT. To change paper or envelope size for a single print job, specify the **-Q** flag with the **qprt** command.

If a font card is installed, the system must be alerted. To handle this, do the following:

1. As the root user, enter `smit chpq`.
2. Select the appropriate print queue and select **Printer Setup** on the **Change/Show Characteristics** menu.
  - Specify which font card is installed in the top card slot.
  - Specify which font card is installed in the bottom card slot.

**Note:** The value of the **nn** variable is the font card identifier, which is the two-digit number just above the arrow on the font card.

If a PostScript option is installed in your 4019 LaserPrinter and the PostScript option supports automatic emulation/mode switching, the printer can be configured to switch automatically between PostScript mode and emulation modes, as well as switching between emulation modes. To determine if the PostScript option installed in your printer supports this, check the guide to operations manual that came with your PostScript option. Or, verify that the PostScript interpreter is version 52.3 or later, by checking the PostScript startup page that is printed when the printer is powered on in PostScript mode (unless it has been disabled). If automatic emulation/mode switching is indicated, notify the system as follows:

1. As the root user, enter `smit chpq`.
2. Select the appropriate print queue and select **Printer Setup** on the **Change/Show Characteristics** menu. Specify **yes** in the **AUTOMATIC MODE SWITCHING for PostScript** attribute.

**Note:**

- a. The Japanese Base System Locale Package must be installed to print Japanese characters.
- b. Japanese characters cannot be printed with PostScript option.
- c. To print multibyte characters, specify 16x16 or 32x32 dot font with the `-F` option using the **qprt** command. For example:

```
qprt -Pkji -F 'RomanKn23,Kanji23,IBM_JPN23' file
```

## IBM 4037 and IBM 4039 LaserPrinter

Product specific information for each printer and queue system is provided.

The system selects the IBM ASCII or PCL emulation data stream without manual intervention.

The printers can print on paper other than the default 8-1/2 by 11 inch size. The paper size can be changed using SMIT. To change paper size for a single print job, specify the `-Q` flag with the **qprt** command.

**Note:**

1. The Japanese Base System Locale Package must be installed to print Japanese characters.
2. Japanese characters cannot be printed with PostScript option.
3. To print multibyte characters, specify 16x16 or 32x32 dot font with the `-F` option using the **qprt** command. For example:

```
qprt -Pkji -F 'RomanKn23,Kanji23,IBM_JPN23' file
```

## IBM 4072 ExecJet

Product specific information for the printer and queue system is provided.

If support for Greek or Turkish characters is needed and an NLS I font card is installed, the system needs to know that the font card is installed:

1. As the root user, enter `smit chpq`.
2. Select the appropriate print queue and select **Printer Setup** on the **Change/Show Characteristics** menu.
  - Specify which font card is installed in the left card slot.
  - Specify which font card is installed in the right card slot.

**Note:** The value of the **nn** variable is the last two digits of the font card part number.

## IBM 4076 InkJet Printer

Product specific information for the printer and queue system is provided.

The system selects the IBM ASCII or PCL emulation data stream without manual intervention.

The InkJet printer can print on paper other than the default 8-1/2 by 11 inch size and on envelopes other than the default #10 envelope. The paper and envelope size can be changed using SMIT. To change paper or envelope size for a single print job, specify the `-Q` flag with the **qprt** command.

## IBM Proprinter Models 4201-3, 4202-3, 4207-2, 4208-2

Product specific information for each printer and queue system is provided.

If support for Greek or Turkish characters is needed and the appropriate font diskette is available, install the fonts by entering the following as root user:

```
piofontin -t PrinterType -c CodePage [-d DeviceName]
```

Specifically, when issuing this command, the **PrinterType** parameter is 4201-3, 4202-3, and the **CodePage** parameter is 851 (Greek) or 853 (Turkish). The **DeviceName** parameter (for example /dev/fd1) is needed only if the diskette device is not /dev/fd0, the standard 3.5-inch diskette drive.

**Note:** If Greek or Turkish fonts have been installed, you must enter the following to download the fonts whenever the printer is turned off and on:

```
sp1p -F! xxx
```

where *xxx* is the device name of the printer, such as **lp0**. This instructs the system to download the Greek or Turkish font to the printer.

## IBM 4208-502, IBM 5572-B02, IBM 5573-H02, and IBM 5579-H02/K02

Product specific information for each printer and queue system is provided.

The Japanese and Proprinter data streams are supported. To print Japanese characters, specify 24x24 dot font with the -F option on the **qprt** command, as follows:

```
qprt -Pkji -F/usr/lib/X11/fonts/JP/IBM_JPN17.pcf.Z file
```

## IBM 4216 Personal Page Printer, Model 031

Product specific information for the printer and queue system is provided.

The switches on the back of the printer must be set for automatic emulation switching, as specified in Appendix B of the *Personal Page Printer II Model 031 Guide to Operations* manual.

The system selects the PostScript, Proprinter XL emulation, PCL emulation, or Diablo 630 emulation without manual intervention.

ASCII files can also be printed using the PostScript data stream.

If you attach the printer to a serial port, you may need to send a special PostScript file to the printer to establish the baud rate, parity, and protocol for the printer. The *Personal Page Printer II Model 031 Guide to Operations* manual contains a sample file.

Print queues for the Proprinter XL, PCL emulation, and Diablo 630 emulations check the first two characters of each print file. If the first two characters are **%!**, the file is assumed to be a PostScript file, and the virtual printer for PostScript is used instead of the virtual printer implied by the print queue name. If you have not configured a print queue for PostScript, the print job will fail.

If you want to print a PostScript file as an ASCII file instead of a PostScript file, specify the -da flag and parameter with the **qprt** command when you submit the print job for the IBM Proprinter XL, PCL emulation, or Diablo 630 emulations.

## IBM 4216-510 and IBM 5327-011

Product specific information for each printer and queue system is provided.

The Japanese data stream is supported. To print Japanese characters, specify 24x24 dot font with the -F option on the **qprt** command. as follows:

```
qprt -Pkji -F/usr/lib/X11/fonts/JP/IBM_JPN17.pcf.Z file
```

## IBM 4234 Printer

Product specific information for the printer and queue system is provided.

The system assumes that the appropriate character set (printed language) has been selected from the printer's control panel. See the section on setting a printed language in the printer's operating instructions manual.

If the selected character set is not 02 (PC Multilingual):

1. Enter the SMIT fast path:

```
smit chpq
```

2. Select the appropriate print queue, and then select **Printer Setup** on the **Change/Show Characteristics** menu.
3. Select the character set for the **PRINTED LANGUAGE** attribute.

## IBM 5202 Quietwriter III

Product specific information for the printer and queue system is provided.

Although this printer detects the presence of a font cartridge, the host system cannot. You must tell the system about the font cartridge in any of the following instances:

- Plug in a font cartridge that includes a font in Code Page 850.
- Print using the font.
- Print characters unique to Code Page 850 (European characters).

To tell the system about the font cartridge:

1. Enter the SMIT fast path:

```
smit chpq
```

2. Select the appropriate print queue and select **Printer Setup** on the **Change/Show Characteristics** menu.
3. Specify **yes** for the **CODE PAGE 850** attribute.

## IBM 5204 Quickwriter

Product specific information for the printer and queue system is provided.

If a font cartridge is installed to support Greek or Turkish:

1. Enter `smit chpq` as the root user.
2. Select the appropriate print queue and select **Printer Setup** on the **Change/Show Characteristics** menu.
3. Specify font cartridge part number for the **Font Cartridge** attribute. Supported values are 1301598 (Greek) and 1301614 (Turkish).

## IBM 5575-B02/F02/H02 and IBM 5577-B02/F02/FU2/G02/H02/J02/K02

Product specific information for each printer and queue system is provided.

To print Japanese characters, specify 24x24 dot font with the `-F` option on the `qprt` command, as follows:

```
qprt -Pkji -F/usr/lib/X11/fonts/JP/IBM_JPN17.pcf.Z file
```

## IBM 5584-G02/H02, IBM 5585-H01, IBM 5587-G01/H01 and IBM 5589-H01

Product specific information for each printer and queue system is provided.

To print Japanese characters, specify 24x24 dot font with the `-F` option on the `qprt` command, as follows:

```
qprt -Pkji -F/usr/lib/X11/fonts/JP/IBM_JPN17.pcf.Z file
```

## IBM 6252 Impactwriter and IBM 6252 Printer

Product specific information for the printers and queue system is provided.

If the active code page for the installed print band is not Code Page 850, you must notify the system:

1. Enter `smit chpq` as the root user.
2. Select the appropriate print queue and select **Printer Setup** on the **Change/Show Characteristics** menu.
3. Select the code page for the **ACTIVE CODE PAGE** attribute.

## IBM Network Color Printer

Product specific information for the printer and queue system is provided.

The predefined files support the IBM Network Color Printer 2.0 or higher controller code level.

Additional `qprt` option flags that are valid using only the Network Color Printer PS queue:

Item	Descriptor
------	------------

-e #	Specifies brightness level.
------	-----------------------------

<b>0</b>	Default Printer Setting
----------	-------------------------

<b>1</b>	Lightest
----------	----------

<b>2</b>	Lighter
----------	---------

<b>3</b>	Light
----------	-------

<b>4</b>	Normal
----------	--------

<b>5</b>	Dark
----------	------

<b>6</b>	Darker
----------	--------

<b>7</b>	Darkest
----------	---------

**Item Descriptor**

-E # Specifies the finish.

- 0** Default Printer Setting
- 1** Normal
- 2** Matte
- 3** Glossy

-k # Specifies the color model.

- 0** Default Printer Setting
- 1** CMYK
- 2** Grayscale

-K # Specifies the color rendering dictionary.

- 0** Default Printer Setting
- 1** Scanner
- 2** Highlight
- 3** Photographic
- 4** Presentation
- 5** Monitor
- 6** Solid Color

-S # Specifies the print mode.

- 0** Default Printer Setting
- 1** Photo Quality
- 2** Business Graphics

The following valid queue names are located on the IBM Network Color Printer:

<b>Item</b>	<b>Descriptor</b>
<b>ibmcolor_direct</b>	1.03 or 1.1 controller code and 16MB of memory.
<b>ibmcolor_print</b>	1.03 or 1.1 controller code and 32MB or 48MB of memory.
<b>ibmncp_direct</b>	2.0 or higher controller code and 16MB of memory.
<b>ibmncp_print</b>	2.0 or higher controller code and 32MB or 48MB of memory.

**Note:** To determine the controller code level and amount of memory on your IBMNetwork Color Printer, print a configuration page from the printer operator panel. See the configuration page under "GENERAL INFO." Memory is the second item, and the third item is version of the controller code. The predefined files on AIX only supports the IBM Network Color Printer 2.0 or higher controller code level.

## IBM Network Printer 12, 17, and 24

Product specific information for the printers and queue system is provided.

IBM Network Printers can print on paper other than the default 8 1/2 by 11 inch size. The paper size can be changed using SMIT, see ["IBM Network Color Printer" on page 142](#) for detail information. To change paper size for a single print job, specify the -Q flag with the **qprt** command.

To print more lines per page than the line space allows (6 or 8 lines per inch), specify the number of lines per page. The line spacing is compressed to allow the larger number of lines to fit on a page. For example, if the line spacing is 6 lines per inch, entering the command `qprt -l 66 FileName` causes the file FileName to print at 66 lines per page instead of the default 60 lines per page.

The IBM Network Printer 12, 17, and 24 support the following fonts and pitches:

Allowed pitch values and fonts

Font	Allowed pitch values
<b>courier</b>	10, 12, or 17 pitch
<b>courier-bold</b>	10, 12, or 17 pitch
<b>courier-italic-bold</b>	10, 12, or 17 pitch
<b>lettergothic</b>	10, 12, or 17 pitch
<b>lettergothic-bold</b>	10, 12, or 17 pitch
<b>lettergothic-italic</b>	10, 12, or 17 pitch
<b>lineprinter</b>	17 pitch

For example, entering the following command `qprt -s Lineprinter -p 17 FileName` causes the file FileName to be printed in lineprinter font at 17 pitch (17 characters per inch).

The following are the type styles for Arabic, Greek, and Hebrew:

Types of Arabic, Greek and Hebrew styles		
Arabic Type Styles	Greek Type Styles	Hebrew Type Styles
typing typing-italic typing-bold typing-bold-italic	grcour grcour-oblique grcour- bold grcour-bold-oblique	shalom shalom-bold shalom- italic shalom-bold-italic
rokaa rokaa-italic rokaa-bold rokaa-bold-italic	grhelvet grhelvet-bold grhelvet- oblique grhelvet-bold-oblique	narkisstam narkisstam-bold narkisstam-italic narkisstam- bold-italic
setting setting-italic setting-bold setting-bold-italic	grtimesnr grtimesnr-bold grtimesnr-oblique grtimesnr- bold-oblique	narkissim narkissim-bold narkissim-italic narkissim-bold- italic

**Note:** Be sure to download the fonts to the Flash SIM or to a hard disk drive on the printer when using the Arabic, Greek, or Hebrew type styles.

The IBM Network Printer 12, 17, and 24 support the following output bins. The output bins can be accessed using the (-=) flag of the **qprt** command. The following table shows the possible values and the corresponding output bin destination.

List of possible values and the corresponding output bin destination for <b>IBM Network Printer 12</b>	
<b>- = value (#)</b>	<b>destination output bin</b>
0	Main output tray
1	Face-up (rear) tray

<b>- = value (#)</b>	<b>destination output bin</b>
0	Main output tray
1	Mail Box Bin 1
2	Mail Box Bin 2
3	Mail Box Bin 3
4	Mail Box Bin 4
5	Mail Box Bin 5
6	Mail Box Bin 6
7	Mail Box Bin 7
8	Mail Box Bin 8
9	Mail Box Bin 9
10	Mail Box Bin 10
50	Offset Bin

List of possible values and the corresponding output bin destination for <b>IBM Network Printer 24</b>	
<b>- = value (#)</b>	<b>destination output bin</b>
0	Auto Output Bin
1	Main Output Tray
2	Face-up (Rear Bin)
3	Upper Finisher Bin Face-down
4	Middle Finisher Bin Face-down
5	Lower Finisher Bin Face-down
6	Upper Finisher Bin Face-up
7	Middle Finisher Bin Face-up
8	Lower Finisher Bin Face-up
9	Auto Finisher Bin Face-down

The following additional **qprt** option flags that are valid using the PS or PCL queue of the Network Printer 24 only:

List of additional flags that are valid by using the Network Printer 24.

---

<b>Item</b>	<b>Descriptor</b>
-------------	-------------------

<b>-e #</b>	Specifies staple and collation. The <b>-e #</b> option flag only works if a face-down finisher bin is selected. See <b>-=</b> option flag for more information.
-------------	---

- |          |                          |
|----------|--------------------------|
| <b>0</b> | Default Printer Setting  |
| <b>1</b> | Portrait Staple          |
| <b>2</b> | Landscape Staple         |
| <b>3</b> | Two Portrait Staples     |
| <b>4</b> | Two Landscape Staples    |
| <b>5</b> | Offset Jog at end of Job |
| <b>6</b> | Offset Jog at end of Set |
| <b>7</b> | No Stapling or Collating |

Valid queue names located on the IBM Network Printer 12, 17, and 24 include:

List of valid queue names on the Network Printer.

---

<b>Item</b>	<b>Descriptor</b>
-------------	-------------------

<b>TEXT</b>	Data that requires line feed and carriage-return processing.
-------------	--

<b>PASS</b>	Data that requires no further processing.
-------------	---

## IBM InfoPrint 20

Product specific information for the printer and queue system is provided.

Product specific information for printer

---

<b>Item</b>	<b>Descriptor</b>
-------------	-------------------

<b>-q #</b>	Specifies print quality options. The <b>-q</b> options for the InfoPrint 20 are:
-------------	--

<b>600</b>	
------------	--

	Specifies 600 dpi
--	-------------------

<b>1200</b>	
-------------	--

	Specifies 1200dpi. This produces prints that appear to have twice the actual printer resolution. 1200dpi print quality is recommended for printing data such as images that were created at 1200dpi.
--	--

Product specific information for printer

*(continued)*

---

<b>Item</b>	<b>Descriptor</b>
-u #	Sets the paper source. The -u options for the InfoPrint 20 are: <b>0</b> Use current input source selected on printer <b>1</b> Tray 1 <b>2</b> Auxiliary tray - manual feed for paper <b>3</b> Auxiliary tray - manual feed for envelopes <b>4</b> Auxiliary tray - automatic <b>5</b> Tray 2 <b>6</b> Envelope tray <b>7</b> Tray 3 <b>9</b> 2000 sheet input drawer
-= #	Sets type of output paper handling. The -= options for the InfoPrint 20 are: <b>0</b> Main <b>1</b> Main with Offset Option set

Product specific information for printer

(continued)

---

<b>Item</b>	<b>Descriptor</b>
-Q #	Specifies paper size for the print job. The -Q options for the InfoPrint 20 are:
<b>1</b>	Letter
<b>2</b>	Legal
<b>3</b>	Folio
<b>4</b>	11 x 17
<b>5</b>	A4
<b>6</b>	B4
<b>7</b>	A3
<b>8</b>	Universal paper size
<b>9</b>	B5-JIS
<b>10</b>	A5
<b>11</b>	Executive
<b>12</b>	Statement
<b>13</b>	Hagaki
<b>14</b>	Monarch envelope
<b>15</b>	COM10 envelope
<b>16</b>	C5 envelope
<b>17</b>	DL envelope
<b>18</b>	Universal envelope size

Product specific information for printer

(continued)

---

<b>Item</b>	<b>Descriptor</b>
-s <i>Name</i>	Specifies a type style with the <i>Name</i> variable. Typestyles for the InfoPrint 20 are: <ul style="list-style-type: none"><li>• courier</li><li>• courier-bold</li><li>• courier-italic</li><li>• courier-bold-italic</li><li>• gothic</li><li>• lineprinter</li><li>• gothic-bold</li><li>• gothic-italic</li><li>• prestige elite</li><li>• prestige elite-bold</li><li>• prestige elite-italic</li><li>• prestige elite-bold-italic</li></ul>

## **IBM InfoPrint 32 Printer**

Product specific information for the printer and queue system is provided.

Product specific information of the printer:

---

<b>Item</b>	<b>Descriptor</b>
-# #	Type of Output Paper Handling.
<b>0</b>	Default Printer Setting
<b>1</b>	Main (Face Down)
<b>2</b>	Face-up (Rear Bin)
<b>3</b>	Finisher Bin 1 (Face Down Top)
<b>4</b>	Finisher Bin 2 (Face Down Middle)
<b>5</b>	Finisher Bin 3 (Face Down Bottom)
<b>9</b>	Any Finisher Bin (Face Down)

Product specific information of the printer:

*(continued)*

---

**Item Descriptor**

- e # Specifies Staple/Collation. This option flag only works if a face down finisher bin is selected (See -- option flag).
  - 0** Default Printer Setting
  - 1** Portrait Staple
  - 2** Landscape Staple
  - 3** Two Portrait Staples
  - 4** Two Landscape Staples
  - 5** Offset Jog at end of Job
  - 6** Offset Jog at end of Set
  - 7** No Stapling or Collating
- k # Specifies the number of RePro Collated Copies. Printer must have a hard disk drive installed to perform this function.
- s # Name Specifies a type style with the Name variable. Examples are courier, courier-bold, courier-italic courier-bold-italic, lettergothic, lineprinter, lettergothic-bold, lettergothic-italic, prestigeelite, prestigeelite-bold, prestigeelite-italic, and prestigeelite-bold-italic.
- u # Sets the paper source to one of the following:
  - 0** Use Current Input Source Selected on Printer
  - 1** Tray 1
  - 2** Auxiliary Tray - Manual Feed (for papers)
  - 3** Auxiliary Tray - Manual Feed (for envelopes)
  - 4** Auxiliary Tray (automatic)
  - 5** Tray 2
  - 6** Envelope Tray
  - 7** Tray 3
  - 8** Tray 4
  - 9** Tray 5

Product specific information of the printer:

*(continued)*

---

**Item    Descriptor**

-z #    Rotates page printer output the number of quarter-turns clockwise as specified by the *Value* variable. The length (-l) and width (-w) values are automatically adjusted accordingly.

**0**

Portrait

**1**

Landscape

**2**

Reverse Portrait

**3**

Reverse Landscape

Product specific information of the printer:

*(continued)*

---

**Item    Descriptor**

-Q #    Specifies paper size for the print job

**1**

Letter

**2**

Legal

**3**

Folio

**4**

11x17

**5**

A4

**6**

B4

**7**

A3

**8**

Universal Paper Size

**9**

B5-JIS

**10**

A5

**11**

Executive

**12**

Statement

**13**

Hagaki

**14**

Monarch Envelope

**15**

COM10 Envelope

**16**

C5 Envelope

**17**

DL Envelope

**18**

Universal Envelope Size

## IBM InfoPrint 40 Printer

Product specific information for the printer and queue system is provided.

product specific information for the printer:

---

<b>Item</b>	<b>Descriptor</b>
-= #	Type of Output Paper Handling. <b>0</b> Default Printer Setting <b>1</b> Main (Face Down) <b>2</b> Face-up (Rear Bin) <b>3</b> Finisher Bin 1 (Face Down Top) <b>4</b> Finisher Bin 2 (Face Down Middle) <b>5</b> Finisher Bin 3 (Face Down Bottom) <b>9</b> Any Finisher Bin (Face Down)
-e #	Specifies Staple/Collation. This option flag only works if a face down finisher bin is selected (See <u>=</u> option flag). <b>0</b> Default Printer Setting <b>1</b> Portrait Staple <b>2</b> Landscape Staple <b>3</b> Two Portrait Staples <b>4</b> Two Landscape Staples <b>5</b> Offset Jog at End of Job <b>6</b> Offset Jog at End of Set <b>7</b> No Stapling or Collating
-k #	Specifies the number of RePro Collated Copies. Printer must have a hard disk drive installed to perform this function.
-s #	Name specifies a type style with the Name variable. Examples are courier, courier-bold, courier-italic, courier-bold-italic, lettergothic, lineprinter, lettergothic-bold, lettergothic-italic, prestigeelite, prestigeelite-bold, prestigeelite-italic, and prestigeelite-bold-italic.

product specific information for the printer:

*(continued)*

---

<b>Item</b>	<b>Descriptor</b>
-u #	Sets the paper source to one of the following:
<b>0</b>	Use Current Input Source Selected on Printer
<b>1</b>	Tray 1
<b>2</b>	Auxiliary Tray - Manual Feed (for papers)
<b>3</b>	Auxiliary Tray - Manual Feed (for envelopes)
<b>4</b>	Auxiliary Tray (automatic)
<b>5</b>	Tray 2
<b>6</b>	Envelope Tray
<b>7</b>	Tray 3
<b>8</b>	Tray 4
<b>9</b>	Tray 5

product specific information for the printer:

*(continued)*

---

<b>Item</b>	<b>Descriptor</b>
-Q #	Specifies the paper size for the print job.
<b>1</b>	Letter
<b>2</b>	Legal
<b>3</b>	Folio
<b>4</b>	11x17
<b>5</b>	A4
<b>6</b>	B4
<b>7</b>	A3
<b>8</b>	Universal Paper Size
<b>9</b>	BJ-JIS
<b>10</b>	A5
<b>11</b>	Executive
<b>12</b>	Statement
<b>13</b>	Hagaki
<b>14</b>	Monarch Envelope
<b>15</b>	COM10 Envelope
<b>16</b>	C5 Envelope
<b>17</b>	DL Envelope
<b>18</b>	Universal Envelope Size
<i>Queue Names</i>	Valid queue names located on the IBM Network Printer 12, 17, 24, and InfoPrint 20, 32, and 40 are as follows:
	<b>TEXT</b> Data that requires line feed, carriage return processing
	<b>PASS</b> Data that requires no further processing

## Canon LASER SHOT LBP-B404PS/Lite

Product specific information for the printer and queue system is provided.

The Japanese PostScript and ASCII data streams are supported on the Canon LASER SHOT LBP-B404PS/Lite printer. Japanese language text files cannot be printed.

## Canon LASER SHOT LBP-B406S/D/E/G, A404/E, A304E

Product specific information for each printer and queue system is provided.

The Japanese code sets are supported on the Canon LASER SHOT LBP-B406S/D/E/G, A404/E, and A304E printers. Do not use the IBM 5575 emulation card. The **lips3** queue cannot be used for models LBP-B406S/D,A404 with LIPS II+ mode.

## Dataproducts LZR 2665 Laser Printer

Product specific information for the printer and queue system is provided.

The data stream (PostScript, Diablo 630) for the Dataproducts LZR 2665 Laser Printer must be manually selected using the control panel. ASCII files can also be printed using the PostScript data stream.

## Hewlett-Packard LaserJets II, III, IIISi, 3005, 4, 4Si, 4Plus, 4V, 4000, 5200, 5Si/5Si MX, 5Si Mopier, 4700 Color, 8000 Color, and 8500 Color

Product specific information for each printer and queue system is provided.

Hewlett-Packard LaserJet printers can print on paper other than the default 8-1/2 by 11 inch size. The paper size can be changed using SMIT. To change paper size for a single print job, specify the `-Q` flag with the **qprt** command.

To print more lines per page than the line space allows (6 or 8 lines per inch), specify the number of lines per page. The line spacing is compressed to allow the larger number of lines to fit on a page. For example, if the lines spacing is 6 lines per inch, entering the command `qprt -l 66 FileName` causes the file specified by the `FileName` parameter to print at 66 lines per page instead of the default 60 lines per page.

The HP LaserJet III, IIISi, and 4 support the following fonts and pitches:

Fonts	Allowed Pitches
<b>courier font</b>	10, 12, or 17 pitch
<b>courier-bold font</b>	10 or 12 pitch
<b>courier-italic font</b>	10 or 12 pitch
<b>lineprinter font</b>	17 pitch

For example, entering the command `qprt -s Lineprinter -p 17 FileName` causes the file `FileName` to be printed in lineprinter font at 17 pitch (17 characters per inch).

Attaching a Hewlett-Packard LaserJet printer to an RS-422A serial port requires a special cable. You can construct the cable using the following pin-out information:

Socket Connector (System End)	Signal	Pin Connector (Device End)
shell	Shield Ground	1
2	TxA	3
3	RxA	9
4	TxB	18

Socket Connector (System End)	Signal	Pin Connector (Device End)
5	RxB	10
7	Signal Ground	7

## Hewlett-Packard LaserJet 3005, 5200 and 4700 Color Printers

Product specific information for each printer and queue system is provided.

### Font name and Pitch

The following fonts and pitch sizes are supported:

Font Name	Allowed pitch values
-s courier	-p (1 to 99)
-s courier-bold	-p (1 to 99)
-s courier-italic	-p (1 to 99)
-s gothic	-p (1 to 99)
-s gothic-bold	-p (1 to 99)
-s gothic-italic	-p (1 to 99)
-s lineprinter	-p 17

**Note:** Only a pitch of 17 is supported for the lineprinter font.

### Paper Type

The following paper type selection is supported by the -y flag of the **qprt** command (HP4700, HP5200):

Item	Paper type	Printer type
-y 0	any	
-y 1	plain	
-y 2	preprinted	
-y 3	letterhead	
-y 4	transparency	
-y 5	prepunched	
-y 6	label	
-y 7	bond	
-y 8	recycled	
-y 9	color	
-y 10	light	
-y 11	heavy	
-y 12	cardstock	
-y 13	rough	
-y 14	vellum	
-y 16	glossy	(HP 4700 only)
-y 17	heavy glossy	(HP 4700 only)

### Envelope Size

The following envelope sizes are supported when the envelope tray is selected as the paper source (-u 3 or -u 4 or -u 5) (HP4700, HP5200):

<b>Item</b>	<b>Descriptor</b>
-Q 1	Monarch
-Q 2	B5
-Q 3	COM-10
-Q 4	DL
-Q 5	C5

### **Collation and Number of Copies**

The printers support collation of multiple copies of a print job internally. This feature of the **qprt** command is controlled by the -W and -S flags, as follows:

<b>Item</b>	<b>Descriptor</b>
-S !	collation off
-S +	collation on
-W #	number of copies

### **Notes:**

1. This function differs from the -N flag supported by the spooler. The -N # flag will cause the print job to be sent to the printer # times. The -W # flag will send the print job once, and # copies of the job will be printed.
2. The function is limited by the amount of memory installed in the printer and the size of the print job.

### **Job Storage**

This feature is supported with -U and -V command flags of the **qprt** command. The -U flag, specifies the Job Storage Mode, as follows:

<b>Item</b>	<b>Job storage mode</b>	<b>Printer type</b>
-U 1	Off	
-U 2	Private Job	
-U 3	Proof and Hold	
-U 4	Quick Copy	(HP4700 only)
-U 5	Quick Copy	(HP4700 only)
-U 6	Stored Job (Private)	(HP4700 only)

The -V flag controls the private print pin number.

-V [0000-9999]

### **HP LaserJet 3005**

The following paper source selection is supported with the -u flag of the **qprt** command:

<b>Item</b>	<b>Descriptor</b>
-u 0	manual paper feed multipurpose tray 1
-u 1	paper feed tray 2
-u 2	paper feed tray 3

<b>Item</b>	<b>Descriptor</b>
-u 3	envelope feed in multipurpose tray 1
-u 4	manual envelope feed in multipurpose tray 1
-u 6	paper feed in multipurpose tray 1
-u 7	auto select

The following paper size selection is supported with the -Q flag of the **qprt** command:

<b>Item</b>	<b>Descriptor</b>
-Q 1	letter
-Q 2	legal
-Q 5	A4
-Q 9	A5
-Q 6	Executive
-Q 8	JISB5
-Q 11	Monarch
-Q 12	B5
-Q 13	COM10
-Q 14	DL
-Q 15	C5
-Q 3	Custom

The following paper type selection is supported with the -y flag of the **qprt** command:

<b>Item</b>	<b>Descriptor</b>
-y 0	Any Type
-y 1	Bond
-y 2	CardStock
-y 4	Envelope
-y 5	Labels
-y 6	LetterHead
-y 7	Light
-y 8	Plain
-y 9	PrePrinted
-y 10	PrePunched
-y 11	Recycled
-y 12	Rough
-y 13	Transparency
-y 14	Vellum

### **HP LaserJet 4700 Color**

The following paper source selection is supported with the -u flag of the **qprt** command:

<b>Item</b>	<b>Descriptor</b>
-u 0	manual paper feed
-u 1	tray 2
-u 2	tray 3
-u 3	envelope (tray 1)
-u 4	manual envelope feed
-u 6	multipurpose tray 1
-u 7	tray 4
-u 8	tray 5
-u 9	tray 6
-u 10	auto select

The following paper size selection is supported with the -Q flag of the **qprt** command:

<b>Item</b>	<b>Descriptor</b>
-Q 1	letter
-Q 2	legal
-Q 5	A4
-Q 6	exec
-Q 8	B5 (JIS)
-Q 9	A5
-Q 10	exec (JIS)
-Q 11	8.5 x 13
-Q 12	statement

## **HP LaserJet 5200**

The following paper source selection is supported with the -u flag of the **qprt** command:

<b>Item</b>	<b>Descriptor</b>
-u 0	manual paper feed
-u 1	tray 2
-u 2	tray 3
-u 3	envelope (tray 1)
-u 4	manual envelope feed
-u 6	multipurpose tray 1
-u 7	auto select

The following paper size selection is supported with the -Q flag of the **qprt** command:

<b>Item</b>	<b>Descriptor</b>
-Q 1	letter
-Q 2	legal

Item	Descriptor
-Q 3	ledger
-Q 4	A3
-Q 5	A4
-Q 6	exec
-Q 7	B4(JIS)
-Q 8	B5(JIS)
-Q 9	A5
-Q 10	exec(JIS)
-Q 11	8.5 x 13
-Q 12	statement

## Hewlett-Packard LaserJet 5Si and 5Si Mopier Printers

Product specific information for the printer and queue system is provided.

### Output bins:

The base LaserJet 5Si and 5Si Mopier printers have two possible destinations:

- **Top output bin** that prints face down.
- **Left-side output bin** that prints face up in reverse order.
- If an optional High Capacity Output (HCO) device is installed, the additional trays are available as well. The base operating system supports up to eight of the HCO output bins for the HP 5Si printer, and up to five for the HCO output bins and a stapler bin for the 5Si Mopier.

The output bins can be accessed using the (-=) flag of the **qprt** command. The following table shows the possible values and the corresponding output bin destination for the LaserJet 5Si:

LaserJet 5Si:	
-= value (#)	destination output bin
0	Printer top/face-down bin
1	HCO face-down bin 1
2	HCO face-down bin 2
3	HCO face-down bin 3
4	HCO face-down bin 4
5	HCO face-down bin 5
6	HCO face-down bin 6
7	HCO face-down bin 7
8	HCO face-down bin 8
50	HCO face-up
50	Printer left/face-up bin (when HCO not installed)

The output bins can be accessed using the (-=) flag of the **qprt** command. The following table shows the possible values and the corresponding output bin destination for the LaserJet 5Si Mopier:

LaserJet 5Si Mopier:	
<b>-= value (#)</b>	<b>destination output bin</b>
0	Printer top/face-down bin
1	HCO face-down bin 1
2	HCO face-down bin 2
3	HCO face-down bin 3
4	HCO face-down bin 4
5	HCO face-down bin 5
50	HCO face-up
50	Printer left/face-up bin (when HCO not installed)
51	Stapler bin

### Number of copies (LaserJet 5Si Mopier):

The LaserJet 5Si Mopier supports printing copies internal with the `-W` flag. This differs from the `-N` flag supported by the spooler. With the `-N` flag, copies are processed on the base operating system machine and then sent to the printer one at a time. However, the `-W` option on the LaserJet 5Si Mopier sends only one copy of the print job to the printer and the copies are then produced by the printer. The basic format is: **`-W #`**

## Hewlett-Packard LaserJet 8000 and 8500 Color Printers

Product specific information for the printer and queue system is provided.

### Output bins:

The base LaserJet 8500 Color and LaserJet 8000 printers have two possible destinations:

- **Top output bin** that prints face down.
- **Left-side output bin** that prints face up in reverse order.

If an optional High Capacity Output (HCO) device is installed, the additional trays are available as well.

The output bins can be accessed using the `(=)` flag of the `qprt` command. The following table shows the possible values and the corresponding output bin destination:

LaserJet 8500 Color:	
<b>-= value (#)</b>	<b>destination output bin</b>
0	Printer top/face-down bin
1	HCO face-down bin 1
2	HCO face-down bin 2
3	HCO face-down bin 3
4	HCO face-down bin 4
5	HCO face-down bin 5
6	HCO face-down bin 6
7	HCO face-down bin 7
8	HCO face-down bin 8

LaserJet 8500 Color: (continued)	
<b>-= value (#)</b>	<b>destination output bin</b>
50	HCO face-up
50	Printer left/face-up bin (when HCO not installed)

LaserJet 8000:	
<b>-= value (#)</b>	<b>destination output bin</b>
0	Printer top/face-down bin
1	HCO face-down bin 1
2	HCO face-down bin 2
3	HCO face-down bin 3
4	HCO face-down bin 4
5	HCO face-down bin 5
6	HCO face-down bin 6
7	HCO face-down bin 7
8	HCO face-down bin 8
50	HCO face-up
50	Printer left/face-up bin (when HCO not installed)
51	Stapler bin

**Number of copies:**

The LaserJet 8000 and 8500 Color printers support printing copies internal. With the `-W` flag, only one copy of the print job is sent to the printer and the copies are then produced by the printer. The basic format is: `-W #`

**Paper size:**

Specifies paper size for the print job:

<b>Print job</b>	<b>Paper size</b>
<b>-Q 1</b>	Letter
<b>-Q 2</b>	Legal
<b>-Q 4</b>	A4
<b>-Q 5</b>	Exec
<b>-Q 8</b>	A3

# Lexmark 4227 Forms Printer

Product specific information for the printer and queue system is provided.

Product specific information

---

<b>Item</b>	<b>Descriptor</b>
<b>Paper Source</b>	<p>Paper source selection is supported by using the -u flag of the <b>qprt</b> command.</p> <p><b>-u 1</b> tractor 1</p> <p><b>-u 2</b> tractor 2</p> <p>The banner and trailer pages use the same source as the print job. It is suggested that the printer be attended when switching between tractors.</p>
<b>Pitch, Font, and Quality</b>	<p>Pitch selection is supported by using the -p flag for the pitch, the -s flag for the font name, and the -q flag of the <b>qprt</b> command for print quality. The default values supported include:</p> <p><b>10</b> pitch</p> <p><b>courier</b> font</p> <p><b>quality</b> 1 or draft</p> <p>The valid font values include:</p> <p><b>Font Name</b></p> <p><b>-s</b> fast draft</p> <p><b>-s</b> draft</p> <p><b>-s</b> courier</p> <p><b>-s</b> gothic</p> <p>The valid quality values include:</p> <p><b>Quality (-q flag)</b></p> <p><b>0</b> fast draft</p> <p><b>1</b> draft</p> <p><b>2</b> near letter quality</p> <p>The valid pitch values are 10, 12, 17, and 20.</p> <p><b>Note:</b></p> <ol style="list-style-type: none"><li>1. Selection of draft or fast draft will override the selected font.</li><li>2. Bold font is supported using the -e flag and emphasized print. Italic font is supported using the -k flag and italic print.</li></ol>

Product specific information

*(continued)*

---

<b>Item</b>	<b>Descriptor</b>
<b>Page Width</b>	The -w flag controls the width of the printable page in characters. The default is <b>136</b> .

## Lexmark Optra Laser Printer

Product specific information for the printer and queue system is provided.

Product specific information

---

<b>Item</b>	<b>Descriptor</b>
<b>Paper Source</b>	<p>Paper source selection is supported for both the enhanced PCL (R) 5 emulation and the PostScript Level 2 emulation by using the -u flag of the <b>qprt</b> command. There are several optional input sources. The input source number is the same for both PCL and PostScript:</p> <ul style="list-style-type: none"><li><b>-u 0</b> manual feed</li><li><b>-u 1</b> tray 1</li><li><b>-u 2</b> tray 2</li><li><b>-u 3</b> tray 3</li><li><b>-u 4</b> feeder or feeder 1</li><li><b>-u 5</b> feeder 2</li></ul>

By default the banner and trailer pages come from the top tray. To change the default, change the values for the **uH** and/or **uT** attributes, respectively, in the colon file to the value for the desired paper source (s0-S5). Use the **lsvirprt** command.

Product specific information

(continued)

---

<b>Item</b>	<b>Descriptor</b>
<b>Paper Size</b>	<p>Paper size selection is supported by using either one or both of the <b>qprt</b> command flags, -0 and -Q. The -0 flag controls paper versus envelopes. A value of 3 indicates a paper size and 4 an envelope size. Envelopes are only valid for manual feed, feeder, or feeder 2. The default for -0 is 3 or paper. The default for -Q is 1 or Letter for paper sizes and Com 10 for envelope sizes.</p> <p><b>Paper Sizes (-0 3)</b> Envelope Sizes (-0 4)</p> <p><b>-Q 1 Letter</b> 7 3/4 Monarch</p> <p><b>-Q 2 Legal</b> 9 (Com 9)</p> <p><b>-Q 3 B5 paper</b> 10 (Com 10)</p> <p><b>-Q 4 A4</b> DL</p> <p><b>-Q 5 Executive</b> C5</p> <p><b>-Q 6 A5</b> B5 Envelope</p> <p><b>-Q 7</b> Other Envelope</p>
<b>Paper Type</b>	<p>The Optra printer supports paper types: rough, normal (default), transparency, labels, and cardstock using the -y parameter of the <b>qprt</b> command or the <b>_y</b> attribute in the colon file.</p> <p><b>-y 1</b> Rough</p> <p><b>-y 2</b> Normal (default)</p> <p><b>-y 3</b> Transparency</p> <p><b>-y 4</b> Labels</p> <p><b>-y 5</b> Cardstock</p>
<b>Print Resolution</b>	<p>The Optra plus printer supports print resolution of 300, 600, and 1200 dpi using the -q flag of the <b>qprt</b> command. The default is 600 dpi.</p> <p><b>-q</b> 300</p> <p><b>-q</b> 600</p> <p><b>-q</b> 1200</p>

(continued)

Item	Descriptor
<b>Pitch</b>	<p>Pitch selection is supported for the PCL 5 emulation by using the <code>-p</code> flag for pitch and the <code>-s</code> flag for font name with the <b>qprt</b> command. Pitch values between 1 and 100 characters per inch (cpi) in whole integers are supported. The condensed print flag, <code>-K</code>, is not supported.</p> <p><b>Font Name</b> Pitch</p> <p><b>-s courier</b> -p (1 to 100)</p> <p><b>-s courier-bold</b> -p (1 to 100)</p> <p><b>-s courier-italic</b> -p (1 to 100)</p> <p><b>-s courier-bold italic</b> -p (1 to 100)</p> <p><b>-s gothic</b> -p (1 to 100)</p> <p><b>-s gothic-bold</b> -p (1 to 100)</p> <p><b>-sgothic-italic</b> -p (1 to 100)</p> <p><b>-s lineprinter</b> -p 17</p>
<b>Duplex Mode</b>	<p><b>Note:</b> To format ASCII for other font styles, use the base operating system <b>enscript</b> utility or the <b>qprt</b> command with the <code>-da</code>, <code>-s</code>, and <code>-p</code> flags to a PostScript queue. For postscript queues, <code>-p</code> stands for point size and the valid list of fonts are located in <code>/usr/lib/ps/fontmap</code>. Valid point sizes are any integer from 1 to 1008. Also, only a pitch of 17 is supported for the lineprinter font style.</p> <p>The optional duplex feature is supported by the <code>-Y</code> flag of the <b>qprt</b> command.</p> <p><b>-Y 0</b> simplex</p> <p><b>-Y 1</b> duplex, long-edge binding</p> <p><b>-Y 2</b> duplex, short-edge binding</p>

# Lexmark Optra Plus LaserPrinter

Product specific information for the printer and queue system is provided.

Product specific information

---

<b>Item</b>	<b>Descriptor</b>
<b>Paper Source</b>	<p>Paper source selection is supported for both the enhanced PCL (R) 5 emulation and the PostScript Level 2 emulation by using the <b>-u</b> flag of the <b>qprt</b> command. There are several optional input sources. The input source number is the same for both PCL and PostScript:</p> <ul style="list-style-type: none"><li><b>-u 0</b> manual feed</li><li><b>-u 1</b> tray 1</li><li><b>-u 2</b> tray 2</li><li><b>-u 3</b> tray 3</li><li><b>-u 4</b> feeder or feeder 1</li><li><b>-u 5</b> feeder 2</li></ul> <p>By default the banner and trailer pages come from the top tray. To change the default, change the values for the <b>uH</b> and/or <b>uT</b> attributes respectively in the colon file to the value for the desired paper source (<b>s0 - S5</b>). Use the <b>lsvirprt</b> command.</p>
<b>Paper Size</b>	<p>Paper size selection is supported by using either one or both of the <b>qprt</b> command flags, <b>-0</b> and <b>-Q</b>. The <b>-0</b> flag controls paper versus envelopes. A value of 3 indicates a paper size and 4 an envelope size. Envelopes are only valid for manual feed, feeder, or feeder 2. The default for <b>-0</b> is 3 or paper. The default for <b>-Q</b> is 1 or Letter for paper sizes and Com 10 for envelope sizes.</p> <p><b>Paper Sizes (-0 3)</b> Envelope Sizes (-0 4)</p> <ul style="list-style-type: none"><li><b>-Q 1 Letter</b> 7 3/4 Monarch</li><li><b>-Q 2 Legal</b> 9 (Com 9)</li><li><b>-Q 3 B5 paper</b> 10 (Com 10)</li><li><b>-Q 4 A4</b> DL</li><li><b>-Q 5 Executive</b> C5</li><li><b>-Q 6 A5</b> B5 Envelope</li><li><b>-Q 7</b> Other Envelope</li></ul>

Product specific information

*(continued)*

---

<b>Item</b>	<b>Descriptor</b>
<b>Paper Type</b>	<p>The Optra Plus printer supports paper types: rough, normal (default), transparency, labels, and cardstock using the -y parameter of the <b>qprt</b> command or the <b>_y</b> attribute in the colon file.</p> <ul style="list-style-type: none"><li><b>-y 1</b> Rough</li><li><b>-y 2</b> Normal (default)</li><li><b>-y 3</b> Transparency</li><li><b>-y 4</b> Labels</li><li><b>-y 5</b> Cardstock</li></ul>
<b>Print Resolution</b>	<p>The Optra Plus printer supports print resolution of 300, 600, and 1200 dpi using the -q flag of the <b>qprt</b> command. The default is 600 dpi.</p> <ul style="list-style-type: none"><li><b>-q</b> 300</li><li><b>-q</b> 600</li><li><b>-q</b> 1200</li></ul>

(continued)

Item	Descriptor
<b>Pitch</b>	<p>Pitch selection is supported for the PCL 5 emulation by using the <code>-p</code> flag for pitch and the <code>-s</code> flag for font name with the <b>qprt</b> command. Pitch values between 1 and 100 characters per inch (cpi) in whole integers are supported. The condensed print flag, <code>-K</code>, is not supported.</p> <p><b>Font Name</b> Pitch</p> <p><b>-s courier</b> -p (1 to 100)</p> <p><b>-scourier-bold</b> -p (1 to 100)</p> <p><b>-scourier-italic</b> -p (1 to 100)</p> <p><b>-scourier-bold italic</b> -p (1 to 100)</p> <p><b>-sgothic</b> -p (1 to 100)</p> <p><b>-s gothic-bold</b> -p (1 to 100)</p> <p><b>-sgothic-italic</b> -p (1 to 100)</p> <p><b>-s lineprinter</b> -p 17</p>
<b>Duplex Mode</b>	<p><b>Note:</b> To format ASCII for other font styles, use the base operating system <b>enscript</b> utility or the <b>qprt</b> command with the <code>-da</code>, <code>-s</code>, and <code>-p</code> flags to a PostScript queue. For PostScript queues, <code>-p</code> stands for point size and the valid list of fonts are located in <code>/usr/lib/ps/fontmap</code>. Valid point sizes are any integer from 1 to 1008. Also, only a pitch of 17 is supported for the lineprinter font style.</p> <p>The optional duplex feature is supported by the <code>-Y</code> flag of the <b>qprt</b> command.</p> <p><b>-Y 0</b> simplex</p> <p><b>-Y 1</b> duplex, long-edge binding</p> <p><b>-Y 2</b> duplex, short-edge binding</p>

(continued)

---

<b>Item</b>	<b>Descriptor</b>
<b>Collation</b>	<p>The Optra Plus printer supports collation of multiple copies of a print job internally. This feature is controlled by the <b>-W</b> and <b>-S</b> flags of the <b>qprt</b> command.</p> <ul style="list-style-type: none"><li data-bbox="464 369 651 426"><b>-S !</b> collation off</li><li data-bbox="464 443 651 499"><b>-S +</b> collation on</li><li data-bbox="464 516 716 573"><b>-S #</b> number of copies</li></ul> <p><b>Note:</b> This function is independent of the <b>-N</b> flag of the <b>qprt</b> command. The <b>-N#</b> flag will cause the printer job to be sent to the printer <b>#</b> times. The <b>-W#</b> will send the print job once, and <b>#</b> copies of the job will be printed.</p>
<b>Separator Pages</b>	<p>The Optra Plus printer supports internally generated separator pages. This feature is controlled by the <b>-E</b> flag of the <b>qprt</b> command.</p> <ul style="list-style-type: none"><li data-bbox="464 789 570 846"><b>-E 0</b> None</li><li data-bbox="464 863 699 919"><b>-E</b> Between Copies</li><li data-bbox="464 936 675 993"><b>-E 2</b> Between Jobs</li><li data-bbox="464 1010 691 1066"><b>-E 3</b> Between Pages</li></ul> <p>The paper source defaults to Feeder. To change the default, the <b>uS</b> attribute must be changed in the virtual printer. The valid values for <b>uS</b> are the same as the paper source flag <b>-u</b> except that manual feed is not a valid source.</p> <p><b>Note:</b> This function is independent of the <b>-B</b> flag of the <b>qprt</b> command.</p>

## Lexmark Optra Color 1200 Printer

Product specific information for the printer and queue system is provided.

Product specific information

---

Item	Descriptor
<b>Paper Source</b>	<p>Paper source selection is supported for both the PCL 5 emulation and the PostScript Language by using the -u flag of the <b>qprt</b> command.</p> <ul style="list-style-type: none"><li><b>-u 0</b> manual feed</li><li><b>-u 1</b> tray 1</li><li><b>-u 2</b> tray 2</li><li><b>-u 3</b> tray 3</li><li><b>-u 4</b> multipurpose feeder</li></ul> <p>By default the banner and trailer pages come from the tray 1. To change the default, change the values for the <b>uH</b> and/or <b>uT</b> attributes, respectively, in the colon file to the value for the desired paper source. Valid values are the same as for the -u flag. Do this by editing the virtual printer colon file by using the <b>chviprt</b> command.</p>

(continued)

Item	Descriptor
<b>Paper Size</b>	<p>Paper size selection is supported by using the <b>qprt</b> command flags, -O and -Q. The -O flag controls paper versus envelope. A -O value of 3 indicates a paper size and 4 an envelope size. The values 1 and 2 were skipped for backward compatibility. The first five paper sizes are also numbered for backward compatibility. Whenever an invalid value for the input source is selected, it will be ignored.</p> <p><b>Note:</b> Envelopes are available through Manual and MP Tray only.</p> <p>The default for -O is <b>3</b> or paper. The default for -Q is <b>1</b> or Letter for paper sizes and Monarch for envelope sizes.</p> <p><b>Paper Sizes (-O 3)</b> Envelope Sizes (-O 4)</p> <p><b>-Q 1 Letter</b> 7 3/4 Monarch</p> <p><b>-Q 2 Legal</b> 9 (Com 9)</p> <p><b>-Q 3 B5</b> 10 (Com 10)</p> <p><b>-Q 4 A4</b> DL</p> <p><b>-Q 5 A5</b> C5</p> <p><b>-Q 6 B4</b> B5 Envelope</p> <p><b>-Q 7 A3</b> Other Envelope</p> <p><b>-Q 8 11 X 17</b> -</p> <p><b>Note:</b> The printer file (lexOptraC1200.pcl) for PCL 5 defaults the paper size to letter. To change the default size, change the values for the <b>s0-s3</b> attributes in the file respectively for the <b>_u</b> (paper source) attributes. For example, to make legal the default size for tray 2, change the <b>s2</b> attribute value to 2.</p> <p><b>Note:</b> For PCL queues, if the selected size is not in the selected input source, a search sequence will be used to find the size requested. If the size is found that source will be used. For PostScript queues, if the selected size is not in the selected input source, the printer will prompt the user to load the source with the appropriate size. This may result in an unexpected paper source being used or an op-panel message that may not make sense at first. See the manual to determine appropriate responses.</p>

*(continued)*

Item	Descriptor
<b>Pitch</b>	<p>Pitch selection is supported for the PCL emulation by using the <code>-p</code> flag for pitch and the <code>-s</code> flag for font name (or type face). Pitch values between 1 and 100 characters per inch (cpi) in whole integers are supported. The condensed print flag, <code>-K</code>, is not supported.</p> <p><b>Font Name</b> Pitch</p> <p><b>-s courier</b> -p (1 to 100)</p> <p><b>-scourier-bold</b> -p (1 to 100)</p> <p><b>-scourier-italic</b> -p (1 to 100)</p> <p><b>-scourier-bold italic</b> -p (1 to 100)</p> <p><b>-sgothic</b> -p (1 to 100)</p> <p><b>-s gothic-bold</b> -p (1 to 100)</p> <p><b>-sgothic-italic</b> -p (1 to 100)</p> <p><b>-s lineprinter</b> -p 17</p>
	<p><b>Note:</b> To format ASCII files for other font styles use the base operating system <code>enscript</code> utility or the <code>qprt</code> command with the <code>-da</code>, <code>-s</code>, and <code>-p</code> flags to a Postscript queue. For Postscript queues, <code>-p</code> stands for point size and the valid list of fonts can be found in <code>/usr/lib/ps/fontmap</code>. Valid point sizes are any integer from 1 to 1008.</p> <p>Only a pitch of 17 is supported for the lineprinter font style.</p>
<b>Collation</b>	<p>Normally, the <code>-N</code> command line option is used to specify the number of copies desired. This method will cause the specified copies of the entire print job to be submitted or queued to the print system. Because the Optra Color 1200 supports collation internally, options were added to support it and the number of copies of each page internally. This functionality- is limited by the amount of memory installed in your printer and the size of the job. The <code>-W#</code> option determines how many copies of each page is desired, where <code>#</code> is the number of copies. The <code>-S [!/+]</code> option controls whether collation is desired. The default is <code>!</code> (or not). The main advantages of using the <code>-W</code> and <code>-S</code> options are to conserve printer subsystem usage and allow the printer to handle multiple copies instead of sending <code>#</code> copies to the printer. Using the <code>-S!</code> options with <code>-W#</code> also allows <code>#</code> copies of each page in a row, if that is desired. Note that using <code>-N</code> and <code>-W</code> simultaneously is allowed. This would result in <code>-N</code> print jobs with <code>-W</code> copies of each page in each job.</p>

Product specific information

*(continued)*

---

<b>Item</b>	<b>Descriptor</b>
<b>Separator Pages</b>	The -E flag controls separator pages. The valid values are <b>0, 1, 2,</b> and <b>3</b> which represent <b>NONE, BETWEENCOPIES, BETWEENJOBS,</b> and <b>BETWEENPAGES</b> respectively. The paper source for separator pages is set via the colon file attribute <b>uS</b> and defaults to TRAY 1. The valid values for <b>uS</b> are the same as <b>uH</b> and <b>uT</b> , except manual feed is not a valid source for separator pages. To change the default, the <b>uS</b> attribute must be changed in the virtual printer to one of the valid values (see the "Paper Source" information for this printer).

## Lexmark Optra Color 40 Printer

Product specific information for the printer and queue system is provided.

Product specific information

---

<b>Item</b>	<b>Descriptor</b>
<b>Paper Source</b>	Paper source selection is supported for both the PCL 5 emulation and the PostScript Language by using the -u flag of the <b>qprt</b> command. <b>-u 0</b> manual feed <b>-u 1</b> tray 1

Item	Descriptor
<b>Paper Size</b>	<p>Paper size selection is supported by using the qprt command flags, -O and -Q. The -O flag controls paper versus envelope. A -O value of 3 indicates a paper size and 4 an envelope size. The values 1 and 2 were skipped for backward compatibility. The first five paper sizes are also numbered for backward compatibility. Whenever an invalid value for the input source is selected, it will be ignored.</p> <p><b>Note:</b> Envelopes available from Manual and Tray 1.</p> <p>The default for -O is <b>3</b> or paper. The default for -Q is <b>1</b> or Letter for paper sizes and Monarch for envelope sizes.</p> <p><b>Paper Sizes (-O 3)</b> Envelope Sizes (-O 4)</p> <p><b>-Q 1 Letter</b> 7 3/4 Monarch</p> <p><b>-Q 2 Legal</b> 9 (Com 9)</p> <p><b>-Q 3 B5</b> 10 (Com 10)</p> <p><b>-Q 4 A4</b> DL</p> <p><b>-Q 5 Executive</b> C5</p> <p><b>-Q 6 A5</b> B5 Envelope</p> <p><b>-Q 7 Universal</b> Other Envelope</p> <p><b>Note:</b> The printer file (lexOptraC40.pcl) for PCL 5 defaults the paper size to letter. To change the default size, change the values for the <b>s0-s3</b> attributes in the file respectively for the <b>_u</b> (paper source) attributes. For example, to make legal the default size for tray 2 change the <b>s2</b> attribute value to 2.</p> <p><b>Note:</b> For PCL queues, if the selected size is not in the selected input source, a search sequence will be used to find the size requested. If the size is found that source will be used. For PostScript queues, if the selected size is not in the selected input source, the printer will prompt the user to load the source with the appropriate size. This may result in an unexpected paper source being used or an operator panel message that may not make sense at first. See the manual to determine appropriate responses.</p>

Item	Descriptor
<b>Pitch</b>	<p>Pitch selection is supported for the PCL emulation by using the -p flag for pitch and the -s flag for font name (or type face). Pitch values between 1 and 100 characters per inch (cpi) in whole integers are supported. The condensed print flag, -K, is not supported.</p> <p><b>Font Name</b> Pitch</p> <p><b>-s courier</b> -p (1 to 100)</p> <p><b>-scourier-bold</b> -p (1 to 100)</p> <p><b>-scourier-italic</b> -p (1 to 100)</p> <p><b>-scourier-bold italic</b> -p (1 to 100)</p> <p><b>-sgothic</b> -p (1 to 100)</p> <p><b>-s gothic-bold</b> -p (1 to 100)</p> <p><b>-sgothic-italic</b> -p (1 to 100)</p> <p><b>-s lineprinter</b> -p 17</p> <p><b>Note:</b> To format ASCII files for other font styles use the base operating system encript utility or the <b>qprt</b> command with the -da, -s, and -p flags to a Postscript queue. For Postscript queues, -p stands for point size and the valid list of fonts can be found in /usr/lib/ps/fontmap. Valid point sizes are any integer from 1 to 1008.</p> <p>Only a pitch of 17 is supported for the lineprinter font style.</p>
<b>Collation</b>	<p>Normally, the -N command line option is used to specify the number of copies desired. This method will cause that many copies of the entire print job to be submitted or queued to the print system. Because the Optra Color 40 supports collation internally, options were added to support it and the number of copies of each page internally. This functionality- is limited by the amount of memory installed in your printer and the size of the job. The -W# option determines how many copies of each page is desired, where # is the number of copies. The -S [!/+] option controls whether collation is desired. The default is ! (or not). The main advantages of using the -W and -S options are to conserve printer subsystem usage and allow the printer to handle multiple copies instead of sending # copies to the printer. Using the -S! options with -W# also allows # copies of each page in a row, if that is desired. Note that using -N and -W simultaneously is allowed. This would result in -N print jobs with -W copies of each page in each job.</p>
<b>Separator Pages</b>	<p>The -E flag controls separator pages. The valid values are <b>0</b>, <b>1</b>, <b>2</b>, and <b>3</b> which represent <b>NONE</b>, <b>BETWEENCOPIES</b>, <b>BETWEENJOBS</b>, and <b>BETWEENPAGES</b> respectively. The paper source for separator pages is set via the colon file attribute <b>uS</b> and defaults to TRAY 1. The valid values for <b>uS</b> are the same as <b>uH</b> and <b>uT</b>, except manual feed is not a valid source for separator pages. To change the default the <b>uS</b> attribute must be changed in the virtual printer to one of the valid values (see paper source above).</p>

## Lexmark Optra Color 45 Printer

Product specific information for the printer and queue system is provided.

Product specific information

---

Item	Descriptor
<b>Paper Source</b>	Paper source selection is supported for both the PCL 5 emulation and the PostScript Language by using the -u flag of the <b>qprt</b> command. <b>-u 0</b> manual feed <b>-u 1</b> tray 1

*(continued)*

Item	Descriptor
<b>Paper Size</b>	<p>Paper size selection is supported by using the qprt command flags, -0 and -Q. The -0 flag controls paper versus envelope. A -0 value of 3 indicates a paper size and 4 an envelope size. The values 1 and 2 were skipped for backward compatibility. The first five paper sizes are also numbered for backward compatibility. Whenever an invalid value for the input source is selected, it will be ignored.</p> <p><b>Note:</b> Envelopes available from Manual and Tray 1.</p> <p>The default for -0 is <b>3</b> or paper. The default for -Q is 1 or Letter for paper sizes and Monarch for envelope sizes.</p> <p><b>Paper Sizes (-0 3)</b> Envelope Sizes (-0 4)</p> <p><b>-Q 1 Letter</b> 7 3/4 Monarch</p> <p><b>-Q 2 Legal</b> 9 (Com 9)</p> <p><b>-Q 3 B5</b> 10 (Com 10)</p> <p><b>-Q 4 A4</b> DL</p> <p><b>-Q 5 A5</b> C5</p> <p><b>-Q 6 Executive</b> B5 Envelope</p> <p><b>-Q 7 A3</b> Other Envelope</p> <p><b>-Q 8 11 X 17</b> -</p> <p><b>-Q 9 Universal</b> -</p> <p><b>Note:</b> The printer file (lexOptraC45.pcl) for PCL 5 defaults the paper size to letter. To change the default size, change the values for the <b>s0-s3</b> attributes in the file respectively for the <b>_u</b> (paper source) attributes. For example, to make legal the default size for tray 2 change the <b>s2</b> attribute value to 2.</p> <p><b>Note:</b> For PCL queues, if the selected size is not in the selected input source, a search sequence will be used to find the size requested. If the size is found that source will be used. For PostScript queues, if the selected size is not in the selected input source, the printer will prompt the user to load the source with the appropriate size. This may result in an unexpected paper source being used or an operator panel message that may not make sense at first. See the manual to determine appropriate responses.</p>

*(continued)*

Item	Descriptor
<b>Pitch</b>	<p>Pitch selection is supported for the PCL emulation by using the <code>-p</code> flag for pitch and the <code>-s</code> flag for font name (or type face). Pitch values between 1 and 100 characters per inch (dpi) in whole integers are supported. The condensed print flag, <code>-K</code>, is not supported.</p> <p><b>Font Name</b> Pitch</p> <p><b>-s courier</b> -p (1 to 100)</p> <p><b>-scourier-bold</b> -p (1 to 100)</p> <p><b>-scourier-italic</b> -p (1 to 100)</p> <p><b>-scourier-bold italic</b> -p (1 to 100)</p> <p><b>-sgothic</b> -p (1 to 100)</p> <p><b>-s gothic-bold</b> -p (1 to 100)</p> <p><b>-sgothic-italic</b> -p (1 to 100)</p> <p><b>-s lineprinter</b> -p 17</p>
<b>Collation</b>	<p><b>Note:</b> To format ASCII files for other font styles use the base operating system <b>enscript</b> utility or the <b>qprt</b> command with the <code>-da</code>, <code>-s</code>, and <code>-p</code> flags to a Postscript queue. For Postscript queues, <code>-p</code> stands for point size and the valid list of fonts can be found in <code>/usr/lib/ps/fontmap</code>. Valid point sizes are any integer from 1 to 1008.</p> <p>Only a pitch of 17 is supported for the lineprinter font style.</p> <p>Normally, the <code>-N</code> command line option is used to specify the number of copies desired. This method will cause that many copies of the entire print job to be submitted or queued to the print system. Because the Optra Color 45 supports collation internally, options were added to support it and the number of copies of each page internally. This functionality- is limited by the amount of memory installed in your printer and the size of the job. The <code>-W#</code> option determines how many copies of each page is desired, where <code>#</code> is the number of copies. The <code>-S [!/+]</code> option controls whether collation is desired. The default is <code>!</code> (or not). The main advantages of using the <code>-W</code> and <code>-S</code> options are to conserve printer subsystem usage and allow the printer to handle multiple copies instead of sending <code>#</code> copies to the printer. Using the <code>-S!</code> options with <code>-W#</code> also allows <code>#</code> copies of each page in a row, if that is desired. Note that using <code>-N</code> and <code>-W</code> simultaneously is allowed. This would result in <code>-N</code> print jobs with <code>-W</code> copies of each page in each job.</p>

Product specific information

(continued)

---

<b>Item</b>	<b>Descriptor</b>
<b>Separator Pages</b>	The -E flag controls separator pages. The valid values are <b>0, 1, 2, and 3</b> which represent <b>NONE, BETWEENCOPIES, BETWEENJOBS, and BETWEENPAGES</b> respectively. The paper source for separator pages is set via the colon file attribute <b>uS</b> and defaults to TRAY 1. The valid values for <b>uS</b> are the same as <b>uH</b> and <b>uT</b> , except manual feed is not a valid source for separator pages. To change the default the <b>uS</b> attribute must be changed in the virtual printer to one of the valid values (see paper source above).

## Lexmark Optra K 1220 Printer

Product specific information for the printer and queue system is provided.

Product specific information

---

<b>Item</b>	<b>Descriptor</b>
<b>Paper Source</b>	<p>Paper source selection is supported for both the "enhanced PCL (R) 5e emulation" and the "PostScript (tm) Level 2 emulation" by using the -u flag of the <b>qprt</b> command. There are several optional input sources (see your manual to determine which are installed). These numbers apply, no matter which ones are present. If one is not present, choosing one of those will simply default as per the user's manual. The input source number is the same for both PCL and PostScript:</p> <ul style="list-style-type: none"><li><b>-u 0</b> manual feed</li><li><b>-u 1</b> tray 1</li><li><b>-u 2</b> tray 2</li><li><b>-u 3</b> multipurpose tray</li></ul> <p>By default the banner and trailer pages come from tray 1. To change the default, change the values for the <b>uH</b> and/or <b>uT</b> attributes, respectively, in the virtual printer to the value for the desired paper source. Do this using the <b>chviprt</b> command. Valid values are the same as for the -u flag.</p>

*(continued)*

Item	Descriptor
<b>Paper Size</b>	<p>Paper size selection is supported by using either one or both of the <b>qprt</b> command flags, <b>-0</b> and <b>-Q</b>. The <b>-0</b> flag controls paper versus envelope. A value of 3 indicates a paper size and 4 an envelope size. The values 1 and 2 were skipped for backward compatibility. Envelopes are only valid for manual feed, envelope feeder, or the multipurpose tray. The default for <b>-Q</b> is 1 or Letter for paper sizes and 3 or Com 10 for envelope sizes. To change the defaults change the <b>s0-s7</b> attributes respectively for each of the valid input sources. Because manual feed and the multipurpose tray support both paper and envelopes, the default for paper is the "else" part (%e1) and the default for envelopes is the "then" part (%t3) of <b>s0</b> and <b>s7</b>.</p>
	<b>Paper Sizes (-0 3)</b>
	Envelope Sizes (-0 4)
	<b>-Q 1 Letter</b>
	7 3/4 Monarch
	<b>-Q 2 Legal</b>
	9 (Com 9)
	<b>-Q 3 B5 (JIS B5)</b>
	10 (Com 10)
	<b>-Q 4 A4</b>
	DL
	<b>-Q 5 Executive</b>
	C5
	<b>-Q 6 A5</b>
	B5 Envelope
	<b>-Q 7 Custom (Universal)</b>
	Other Envelope
	<p><b>Note:</b> For PCL queues, if the selected size is not in the selected input source, a search sequence will be used to find the size requested. If the size is found that source will be used. For PostScript queues, if the selected size is not in the selected input source, the printer will prompt the user to load the source with the appropriate size. This may result in an unexpected paper source being used or an op-panel message that may not make sense at first. See the manual to determine appropriate responses.</p>

Product specific information

(continued)

---

<b>Item</b>	<b>Descriptor</b>
<b>Pitch</b>	<p>Pitch selection is supported for the PCL emulation by using the <code>-p</code> flag for pitch and the <code>-s</code> flag for font name (or type face). Pitch values between 1 and 100 characters per inch (dpi) in whole integers are supported. The condensed print flag, <code>-K</code>, is not supported.</p> <p><b>Font Name</b> Pitch</p> <p><b>-s courier</b> -p (1 to 100)</p> <p><b>-scourier-bold</b> -p (1 to 100)</p> <p><b>-scourier-italic</b> -p (1 to 100)</p> <p><b>-scourier-bold italic</b> -p (1 to 100)</p> <p><b>-sgothic</b> -p (1 to 100)</p> <p><b>-s gothic-bold</b> -p (1 to 100)</p> <p><b>-sgothic-italic</b> -p (1 to 100)</p> <p><b>-s lineprinter</b> -p 17</p> <p><b>Note:</b> To format ASCII files for other font styles use the base operating system <code>enscript</code> utility or the <code>-da</code> flag to a Postscript queue with the <code>qprt</code> command. Also, only a pitch of 17 is supported for the lineprinter font style.</p>
<b>Collation</b>	<p>Normally, the <code>-N</code> command line option is used to specify the number of copies desired. This method will cause the specified number of copies of the entire print job to be submitted or queued to the print system. Because the Optra K 1220 supports collation internally, options were added to support it and the number of copies of each page internally. This functionality is limited by the amount of memory installed in your printer and the size of the job. The <code>-W#</code> option determines how many copies of each page is desired, where <code>#</code> is the number of copies. The <code>-S [!/+]</code> option controls whether collation is desired. The default is <code>!</code> (or not). The main advantages of using the <code>-W</code> and <code>-S</code> options are to conserve printer subsystem usage and allow the printer to handle multiple copies instead of sending <code>#</code> copies to the printer. Using the <code>-S!</code> options with <code>-W#</code> also allows <code>#</code> copies of each page in a row, if that is desired. Note that using <code>-N</code> and <code>-W</code> simultaneously is allowed. This would result in <code>-N</code> print jobs with <code>-W</code> copies of each page in each job.</p>
<b>Separator Pages</b>	<p>The <code>-E</code> flag controls separator pages. The valid values are <b>0</b>, <b>1</b>, <b>2</b>, and <b>3</b> which represent <b>NONE</b>, <b>BETWEENCOPIES</b>, <b>BETWEENJOBS</b>, and <b>BETWEENPAGES</b> respectively. The paper source for separator pages is set via the colon file attribute <code>uS</code> and defaults to <code>TRAY 1</code>. The valid values for <code>uS</code> are the same as <code>uH</code> and <code>uT</code>, except manual feed is not a valid source for separator pages. To change the default, the <code>uS</code> attribute must be changed in the virtual printer to one of the valid values (see paper source above).</p>

# Lexmark Optra C Color LaserPrinter

Product specific information for the printer and queue system is provided.

Product specific information

---

Item	Descriptor
<b>Printing Color Files in PCL 5 Emulation Mode</b>	<p>To print color files, or any pre-formatted print job in PCL language, use the <code>-dp</code> flag of the <b>qprt</b> command. This sets the base operating system printer backend to passthrough mode and should be used any time you are printing from an application in PCL emulation.</p> <p>The print queue default can be changed to passthrough by modifying the <code>_d</code> attribute in the colon file.</p>
<b>Paper Source</b>	<p>Paper source selection is supported for both the PCL 5 emulation and the PostScript Language by using the <code>-u</code> flag of the <b>qprt</b> command.</p> <p><b>PCL</b> PostScript</p> <p><b>-u 1 Top tray</b> -u 1 Top tray</p> <p><b>-u 2 Bottom tray</b> -u 2 Bottom tray</p> <p><b>-u 3 feeder</b> -u 3 feeder</p>
<b>Paper Size</b>	<p>Paper size selection is supported for the PCL 5 emulation by using the <code>-Q</code> flag of the <b>qprt</b> command.</p> <p><b>Paper Sizes</b> Size</p> <p><b>-Q 1</b> Letter (default)</p> <p><b>-Q 2</b> Legal</p> <p><b>-Q 3</b> B5</p> <p><b>-Q 4</b> A4</p> <p>To change the default size, change the values for the <b>s1-s3</b> attributes in the file. For example, to make A4 the default size for all paper sources, change <b>s1</b>, <b>s2</b>, and <b>s3</b> to 4. This changes the top tray, bottom tray, and feeder tray sizes respectively.</p>

Item	Descriptor
<b>Pitch</b>	<p>Pitch selection is supported for the PCL 5 emulation by using the -p flag for pitch and the -s flag for font name with the <b>qprt</b> command. Pitch values between 1 and 100 characters per inch (cpi) in whole integers are supported. The condensed print flag, -K, is not supported.</p> <p><b>Font Name</b> Pitch</p> <p><b>-s courier</b> -p (1 to 100)</p> <p><b>-s courier-bold</b> -p (1 to 100)</p> <p><b>-s courier-italic</b> -p (1 to 100)</p> <p><b>-s courier-bold italic</b> -p (1 to 100)</p> <p><b>-s gothic</b> -p (1 to 100)</p> <p><b>-s gothic-bold</b> -p (1 to 100)</p> <p><b>-s gothic-italic</b> -p (1 to 100)</p> <p><b>-s lineprinter</b> -p 17</p>
<b>Collation</b>	<p><b>Note:</b> To format ASCII for other font styles, use the base operating system <b>enscript</b> utility or the <b>qprt</b> command with the -da, -s, and -p flags to a PostScript queue. For PostScript queues, -p stands for point size and the valid list of fonts are located in /usr/lib/ps/fontmap. Valid point sizes are any integer from 1 to 1008.</p> <p>Also, only a pitch of 17 is supported for the lineprinter font style.</p> <p>The Optra C printer supports collation of multiple copies of a print job internally. This feature is controlled by the -W and -S flags of the <b>qprt</b> command.</p> <p><b>-S!</b> collation off</p> <p><b>-S+</b> collation on</p> <p><b>-S+</b> number of copies</p> <p><b>Note:</b> This function is independent of the -N flag of the <b>qprt</b> command. The -N# flag will cause the print job to be sent to the printer # times. The -W# flag will send the print job once, and # copies of the job will be printed.</p>

Item	Descriptor
<b>Separator Pages</b>	<p>The Optra C printer supports internally generated separator pages. This feature is controlled by the -E flag of the <b>qprt</b> command.</p> <p><b>-E 0</b> None</p> <p><b>-E 1</b> Between Copies</p> <p><b>-E 2</b> Between Jobs</p> <p><b>-E 3</b> Between Pages</p> <p>The paper source defaults to Feeder. To change the default, the <b>uS</b> attribute must be changed in the virtual printer. The valid values for <b>uS</b> are the same as the paper source flag.</p> <p><b>Note:</b> This function is independent of the -B flag of the <b>qprt</b> command.</p>

**Related information**

[lsvirprt Command](#)

## Lexmark Optra E LaserPrinter

Product specific information for the printer and queue system is provided.

Product specific information

Item	Descriptor
<b>Paper Source</b>	<p>Paper source selection is supported for both the PCL 5 emulation and the PostScript Language by using the -u flag of the <b>qprt</b> command.</p> <p><b>PCL</b></p> <p><b>-u 1</b> manual feed</p> <p><b>-u 2</b> top tray</p> <p><b>-u 3</b> bottom tray</p> <p>By default the banner and trailer pages come from the top tray. To change the default, change the values for the <b>uH</b> and/or <b>uT</b> attributes respectively in the colon file to the value for the desired paper source (<b>s1-s3</b>). Use the <b>lsvirprt</b> command.</p>

Product specific information

(continued)

---

<b>Item</b>	<b>Descriptor</b>
<b>Paper Size</b>	<p>Paper size selection is supported for the PCL 5 emulation by using the <code>-Q</code> and <code>-0</code> flags of the <b>qprt</b> command. A value of 3 for the <code>-0</code> flag indicates paper and a value of 4 indicates envelope. Envelopes are not valid in tray 2.</p> <p><b>Paper Sizes (-0 3)</b> Envelope Sizes (-0 4)</p> <ul style="list-style-type: none"><li><b>-Q 1 Letter</b> 7 3/4 Monarch</li><li><b>-Q 2 Legal</b> 9 (Com 9)</li><li><b>-Q 3 B5 paper</b> 10 (Com 10)</li><li><b>-Q 4 A4</b> DL</li><li><b>-Q 5</b> Executive C5</li><li><b>-Q 6 A5</b> B5 Envelope</li><li><b>-Q 7</b> Other Envelope</li></ul> <p><b>Note:</b> The printer file (<code>opttra_e.pcl</code>) for PCL 5 defaults the paper size to letter. To change the default size, change the values for the <b>s1-s3</b> attributes in the file. For example, to make A4 the default size for all paper sources, change <b>s1</b>, <b>s2</b>, and <b>s3</b> to 4. This changes the top tray, bottom tray, and feeder tray sizes respectively.</p>
<b>Paper Type</b>	<p>The Optra E printer supports paper types: rough, normal (default), transparency, labels, and cardstock using the <code>-y</code> parameter of the <b>qprt</b> command or the <code>_y</code> attribute in the colon file.</p> <ul style="list-style-type: none"><li><b>-y 1</b> Rough</li><li><b>-y 2</b> Normal (default)</li><li><b>-y 3</b> Transparency</li><li><b>-y 4</b> Labels</li><li><b>-y 5</b> Cardstock</li></ul> <p><b>Note:</b> These values apply only to paper and not envelopes. The only values supported for tray 2 are rough and normal.</p>
<b>Print Resolution</b>	<p>The Optra E printer supports print resolution of 300 and 600 dpi using the <code>-q</code> flag of the <b>qprt</b> command. The default is 300 dpi.</p> <ul style="list-style-type: none"><li><b>-q</b> 300</li><li><b>-q</b> 600</li></ul>

(continued)

Item	Descriptor
<b>Pitch</b>	<p>Pitch selection is supported for the PCL 5 emulation by using the <code>-p</code> flag for pitch and the <code>-s</code> flag for font name with the <b>qprt</b> command. Pitch values between 1 and 100 characters per inch (cpi) in whole integers are supported. The condensed print flag, <code>-K</code>, is not supported.</p>
	<p><b>Font Name</b> Pitch</p> <ul style="list-style-type: none"> <li><b>-s courier</b> -p (1 to 100)</li> <li><b>-s courier-bold</b> -p (1 to 100)</li> <li><b>-s courier-italic</b> -p (1 to 100)</li> <li><b>-s courier-bold italic</b> -p (1 to 100)</li> <li><b>-sgothic</b> -p (1 to 100)</li> <li><b>-s gothic-bold</b> -p (1 to 100)</li> <li><b>-s gothic-italic</b> -p (1 to 100)</li> <li><b>-s lineprinter</b> -p 17</li> </ul>
	<p><b>Note:</b> To format ASCII for other font styles, use the base operating system <b>enscript</b> utility or the <b>qprt</b> command with the <code>-da</code>, <code>-s</code>, and <code>-p</code> flags to a PostScript queue. For postscript queues, <code>-p</code> stands for point size and the valid list of fonts are located in <code>/usr/lib/ps/fontmap</code>. Valid point sizes are any integer from 1 to 1008.</p>
	<p>Also, only a pitch of 17 is supported for the lineprinter font style.</p>
<b>Number of Copies for Each Page</b>	<p>The <code>-W</code> flag allows the user to control how many copies of each page is produced by the printer itself. For example, if a three-page job is submitted with the <code>-W</code> flag of the <b>qprt</b> command, then 2 copies of page one, followed by 2 copies of page two, followed by 2 copies of page three will be printed. The default value is 1, and the maximum value is 999.</p>

# Lexmark Optra N LaserPrinter

Product specific information for the printer and queue system is provided.

Product specific information

---

Item	Descriptor
<b>Paper Source</b>	<p>Paper source selection is supported for both the enhanced PCL (R) 5 emulation and the PostScript Level 2 emulation by using the -u flag of the <b>qprt</b> command. There are several optional input sources (see your printer documentation to determine which are installed). The optional input sources apply no matter which ones are installed. If one is not present, choosing one will use the default. The input source number is for both PCL and PostScript:</p> <ul style="list-style-type: none"><li data-bbox="391 527 586 585"><b>-u 0</b> manual feed</li><li data-bbox="391 600 505 659"><b>-u 1</b> tray 1</li><li data-bbox="391 674 505 732"><b>-u 2</b> tray 2</li><li data-bbox="391 747 505 806"><b>-u 3</b> tray 3</li><li data-bbox="391 821 630 879"><b>-u 4</b> envelope feeder</li><li data-bbox="391 894 647 953"><b>-u 5</b> multipurpose tray</li></ul>
<b>Paper Size</b>	<p>Paper size selection is supported by using -O and -Q flags of the <b>qprt</b> command. The -O flag controls paper versus envelope. A -O value of 3 indicates a paper size and 4 an envelope size. The values 1 and 2 were skipped for backward compatibility. The first five paper sizes are also numbered for backward compatibility. Whenever an invalid value for the input source is selected, it is ignored.</p>

(continued)

Item	Descriptor
	The default for -0 is 3 or paper. The default for -Q is 1 or Letter for paper sizes and Monarch for envelope sizes.
	<b>Paper Sizes (-0 3)</b>
	Envelope Sizes (-0 4)
	<b>-Q 1 Letter</b>
	7 3/4 Monarch
	<b>-Q 2 Legal</b>
	9 (Com 9)
	<b>-Q 3 B5 paper</b>
	10 (Com 10)
	<b>-Q 4 A4</b>
	DL
	<b>-Q 5 Executive</b>
	C5
	<b>-Q 6 A5</b>
	B5 Envelope
	<b>-Q 7 B4</b>
	Other Envelope (MPT only)
	<b>-Q 8 A3</b>
	<b>-Q 9 Ledger (11x17)</b>
	<b>-Q 10 Custom (11.69x17.69)</b>

To change the defaults, change the **s0** - **s5** attributes for each valid input value. Because manual feed, envelope feeder, and the multipurpose tray support both paper and envelopes, to change the defaults, edit **s0**, **s4**, or **s5**. For these three, the default for paper is the "else" part (%e1), and the default for envelopes is the "then" part (%t3).

**Note:**

1. Envelopes are only valid for manual feed, envelope feeder, or the multipurpose tray.
2. Trays 1, 2, and 3 support only paper sizes.
3. The multipurpose tray (MPT) supports both paper and envelopes.
4. Tray 1 supports sizes -Q 1, 2, 4, and 7 (Letter, Legal, A4, and B4).
5. Trays 2 and 3 support sizes -Q 1, 2, 4, 7, 8, 9 (Letter, Legal, A4, B4, A3, Ledger).
6. The multipurpose tray supports all sizes of paper and envelopes.
7. The other envelope size is supported only by the multipurpose tray.
8. The printer and colon file defaults paper size to Letter for the US and A4 for Europe, and envelope size to COM10 for the US and DL for Europe.
9. Whenever an invalid value for the input source is selected, an error will be reported.
10. If the selected size is not in the input source selected (wrong size or empty), a search sequence is used to find the size requested. See your printer documentation for more information.

*(continued)*

---

<b>Item</b>	<b>Descriptor</b>
<b>Pitch</b>	<p>Pitch selection is supported for the PCL 5 emulation by using the <code>-p</code> flag for pitch and the <code>-s</code> flag for font name with the <b>qprt</b> command. Pitch values between 1 and 100 characters per inch (cpi) in whole integers are supported. The condensed print flag, <code>-K</code>, is not supported.</p> <p><b>Font Name</b> Pitch</p> <p><b>-s courier</b> -p (1 to 100)</p> <p><b>-s courier-bold</b> -p (1 to 100)</p> <p><b>-s courier-italic</b> -p (1 to 100)</p> <p><b>-s courier-bold italic</b> -p (1 to 100)</p> <p><b>-s gothic</b> -p (1 to 100)</p> <p><b>-s gothic-bold</b> -p (1 to 100)</p> <p><b>-s gothic-italic</b> -p (1 to 100)</p> <p><b>-s lineprinter</b> -p 17</p> <p><b>Note:</b> To format ASCII for other font styles, use the base operating system <code>enscript</code> utility or the <b>qprt</b> command with the <code>-da</code>, <code>-s</code>, and <code>-p</code> flags to a PostScript queue. For PostScript queues, <code>-p</code> stands for point size and the valid list of fonts are located in <code>/usr/lib/ps/fontmap</code>. Valid point sizes are any integer from 1 to 1008. Also, only a pitch of 17 is supported for the lineprinter font style.</p>
<b>Duplex Mode</b>	<p>The optional duplex feature is supported by the <code>-Y</code> flag of the <b>qprt</b> command.</p> <p><b>-Y 0</b> simplex</p> <p><b>-Y 1</b> duplex, long-edge binding</p> <p><b>-Y 2</b> duplex, short-edge binding</p>

(continued)

---

<b>Item</b>	<b>Descriptor</b>
<b>Collation and Number of Copies</b>	<p>The Optra N printer supports collation of multiple copies of a print job internally. This feature is controlled by the -W and -S flags of the <b>qprt</b> command.</p> <p><b>-S !</b> collation off</p> <p><b>-S +</b> collation on</p> <p><b>-W #</b> number of copies</p> <p><b>Note:</b></p> <ol style="list-style-type: none"><li>1. This function is independent of the -N flag of the <b>qprt</b> command. The -N# flag causes the printer to send the job to the printer times. The -W# sends the print job once, and # copies of the job are printed.</li><li>2. The function is limited by the amount of memory installed in the printer and the size of the print job.</li></ol>
<b>Separator Pages</b>	<p>The Optra N printer supports internally generated separator pages. This feature is controlled by the -E flag of the <b>qprt</b> command.</p> <p><b>-E 0</b> None</p> <p><b>-E 1</b> Between Copies</p> <p><b>-E 2</b> Between Jobs</p> <p><b>-E 3</b> Between Pages</p> <p>The paper source defaults to tray 1. To change the default, the <b>uS</b> attribute must be changed in the virtual printer. The valid values for uS are:</p> <p><b>uS 1</b> tray 1</p> <p><b>uS 2</b> tray 2</p> <p><b>uS 3</b> tray 3</p> <p><b>uS 4</b> envelope feeder</p> <p><b>uS 5</b> multipurpose tray</p> <p><b>Note:</b> This function is independent of the -B flag of the <b>qprt</b> command.</p>

(continued)

Item	Descriptor
<b>Output Bin</b>	<p>The equal sign (=) is the command line option for specifying the output destination. Valid values are:</p> <p><b>0</b> printer top bin</p> <p><b>1</b> finisher bin 1</p> <p><b>2</b> finisher bin 2</p> <p><b>3</b> finisher bin 3</p> <p><b>50</b> printer side bin</p> <p>The printer top bin or 0 is the default value for the output bin.</p> <p><b>Note:</b> If the printer side bin is selected and the finisher option is installed, the output will go to the active bin.</p>
<b>Faceup or Facedown</b>	<p>The -U option controls whether paper is output face-up or face-down for the finisher.</p> <p><b>Note:</b> The printer top bin is always facedown. A value of + or true indicates face-down and is the default. A value of ! or false indicates face-up. If face-up is selected the staples (-y) and job offset (-e) are ignored.</p>
<b>Staples</b>	<p>The -y option controls whether staples are desired or not. Only certain paper sizes are supported for each of the values for this flag. Also, there are several rules about output quantities and destinations. See your printer documentation for details on all the possibilities. The valid values are:</p> <p><b>0</b> no staples (default)</p> <p><b>1</b> one staple (top left)</p> <p><b>2</b> two staples (left side)</p>
<b>Job Offset</b>	<p>The -e flag controls whether offsetting the first page of each job in the finisher bin is desired. The first page is offset toward the front of the finisher by 1.7 inches. The offset function is ignored if staples are not off. Separator sheets may be selected independently of offset. The valid values are:</p> <p><b>+</b> job offset ON</p> <p><b>!</b> job offset OFF (default)</p>

# Lexmark Optra E310 Laser Printer

Product specific information for the printer and queue system is provided.

Product specific information

Item	Description
<b>Page Rotation</b>	<p>Page rotation selection is supported for the PCL 5 emulation by using the <code>-z</code> flag of the <code>qpri</code> command.</p> <p><b>-z 0</b> Portrait</p> <p><b>-z 1</b> Landscape</p>
<b>Paper Source</b>	<p>Paper source selection is supported for both the enhanced PCL 5 emulation and the PostScript Level 2 emulation by using the <code>-u</code> flag of the <code>qpri</code> command. The input source number is the same for both PCL and PostScript:</p> <p><b>-u 0</b> manual feed</p> <p><b>-u 1</b> tray 1</p> <p>By default, the banner and trailer pages come from the top tray. To change the default, change the values for the <code>uH</code> and/or <code>uT</code> attributes respectively in the colon file to the value for the desired paper source. The valid values are the same as for the <code>-u</code> flag. Do this by editing the virtual printer colon file by using the <code>chvirpri</code> command.</p>
<b>Paper Size</b>	<p>Paper size selection is supported by using <code>-O</code> and <code>-Q</code> flags of the <code>qpri</code> command. The <code>-O</code> flag controls paper versus envelope. A <code>-O</code> value of 3 indicates a paper size and 4 an envelope size.</p> <p><b>Paper Sizes (-O 3)</b> Envelope Sizes (-O 4)</p> <p><b>-Q 1 Letter</b> 7 3/4 Monarch</p> <p><b>-Q 2 Legal</b> 9 (Com 9)</p> <p><b>-Q 3 B5</b> 10 (Com 10)</p> <p><b>-Q 4 A4</b> DL</p> <p><b>-Q 5 Executive</b> C5</p> <p><b>-Q 6 A5</b> B5 Envelope</p> <p><b>-Q 7</b> Other Envelope (MPT only)</p> <p>To change the defaults, change the <code>s1</code>, <code>s3</code> attribute values in the <code>lexOptraE310.pcl</code> colon file. The default for paper size is 1 or letter, and the default for envelopes is 3 or Com 10. The letter value is the <i>else</i> part (<code>%e1</code>) of the <code>s1</code> and <code>s3</code> attributes, and the envelope is the <i>then</i> part (<code>%t3</code>).</p>

*(continued)*

Item	Description
<b>Paper Type</b>	<p>The Optra E310 printer supports paper types ROUGH, NORMAL (default), TRANSPARENCY, LABELS, and CARDSTOCK via the <code>-y</code> parameter to the <b>qppt</b> command, or the <code>-y</code> attribute in the colon file. The values to the <code>-y</code> option are 1 through 5 respectively for the above types.</p> <p><b>-y 1</b> Bond</p> <p><b>-y 2</b> Plain</p> <p><b>-y 3</b> Transparency</p> <p><b>-y 4</b> Labels</p> <p><b>-y 5</b> Cardstock</p> <p><b>Note:</b> These values do not apply to envelopes.</p>
<b>Pitch</b>	<p>Pitch selection is supported for the PCL emulation by using the <code>-p</code> flag for pitch and the <code>-s</code> flag for font name (or type face) with the <b>qppt</b> command. Pitch values between 1 and 100 characters per inch (cpi) in whole integers are supported. The condensed print flag, <code>-K</code>, is not supported.</p> <p><b>Font Name</b> Pitch</p> <p><b>-s courier</b> -p (1 to 100)</p> <p><b>-s courier-bold</b> -p (1 to 100)</p> <p><b>-s courier-italic</b> -p (1 to 100)</p> <p><b>-s courier-bolditalic</b> -p (1 to 100)</p> <p><b>-s gothic</b> -p (1 to 100)</p> <p><b>-s gothic-bold</b> -p (1 to 100)</p> <p><b>-s gothic-italic</b> -p (1 to 100)</p> <p><b>-s lineprinter</b> -p 17</p> <p><b>Note:</b> To format ASCII for other font styles, use the base operating system <b>enscript</b> utility or the <b>qppt</b> command with the <code>-da</code>, <code>-s</code>, and <code>-p</code> flags to a PostScript queue. For PostScript queues, <code>-p</code> stands for point size and the valid list of fonts is located in <code>/usr/lib/ps/fontmap</code>. Valid point sizes are any integer from 1 to 1008.</p> <p>Only a pitch of 17 is supported for the lineprinter font style.</p>

Product specific information

(continued)

---

Item	Description
<b>Number of Copies for Each Page</b>	<p>The <code>-W</code> flag of the <b>qprt</b> command controls how many copies of each page is printed. The default is 1 copy, and the maximum value is 999.</p> <p><b>-w #</b> number of copies</p> <p><b>Example:</b> If a three-page job is submitted with <code>-W2</code> on the <b>qprt</b> command, then two copies of page 1 followed by two copies of page 2 followed by two copies of page 3 will occur in that order.</p>

## Lexmark Optra M410 Laser Printer

Product specific information for the printer and queue system is provided.

Product specific information

---

Item	Descriptor
<b>Page Rotation</b>	<p>Page rotation selection is supported for the PCL 5e emulation by using the <code>-z</code> flag of the <b>qprt</b> command.</p> <p><b>-z 0</b> Portrait</p> <p><b>-z 1</b> Landscape</p>
<b>Paper Source</b>	<p>Paper source selection is supported for both the enhanced PCL (R) 5e emulation and the PostScript Level 2 emulation by using the <code>-u</code> flag of the <b>qprt</b> command. There are several optional input sources (see your manual to determine which are installed). These numbers apply, no matter which ones are present. If one is not present, choosing one of those will simply default as per the user's manual. The input source number is the same for both PCL and PostScript:</p> <p><b>-u 0</b> manual feed</p> <p><b>-u 1</b> tray 1</p> <p><b>-u 2</b> tray 2</p> <p><b>-u 3</b> multipurpose tray</p> <p>By default, the banner and trailer pages come from tray 1. To change the default, change the values for the <b>uH</b> and/or <b>uT</b> attributes, respectively, in the virtual printer to the value for the desired paper source. The valid values are the same as for the <code>-u</code> flag. Do this by editing with the <b>chvirprt</b> command.</p>

*(continued)*

Item	Descriptor
<b>Paper Size</b>	<p>Paper size selection is supported by using either one or both of the <b>qprt</b> command flags, <b>-O</b> and <b>-Q</b>. The <b>-O</b> flag controls paper versus envelope. A <b>-O</b> value of 3 indicates a paper size and 4 an envelope size. The values 1 and 2 were skipped for backward compatibility. Envelopes are only valid for manual feed, envelope feeder, or the multipurpose tray. The default for <b>-Q</b> is 1 or Letter for paper sizes, and 3 or Com 10 for envelope sizes. To change the defaults, change the <b>s0</b> - <b>s7</b> attributes respectively for each of the valid input sources. Because manual feed and the multipurpose tray support both paper and envelopes, the default for paper is the <i>else</i> part (%e1), and the default for envelopes is the <i>then</i> part (%t3) of <b>s0</b> and <b>s7</b>.</p>
	<p><b>Paper Sizes (-O 3)</b> Envelope Sizes (-O 4)</p>
	<p><b>-Q 1 Letter</b> 7 3/4 Monarch</p>
	<p><b>-Q 2 Legal</b> 9 (Com 9)</p>
	<p><b>-Q 3 B5 (JIS B5)</b> 10 (Com 10)</p>
	<p><b>-Q 4 A4</b> DL</p>
	<p><b>-Q 5 Executive</b> C5</p>
	<p><b>-Q 6 A5</b> B5 Envelope</p>
	<p><b>-Q 7 Custom (Universal)</b> Other Envelope</p>
	<p><b>Note:</b> For PCL queues, if the selected size is not in the selected input source, a search sequence will be used to find the size requested. If the size is found, that source will be used. For PostScript queues, if the selected size is not in the selected input source, the printer will prompt the user to load the source with the appropriate size. This may result in an unexpected paper source being used or an operator panel message that may not make sense at first. See the manual to determine appropriate responses.</p>

*(continued)*

Item	Descriptor
<b>Pitch</b>	<p>Pitch selection is supported for the PCL 5 emulation by using the <code>-p</code> flag for pitch and the <code>-s</code> flag for font name (or type face) with the <b>qp<code>prt</code></b> command. Pitch values between 1 and 100 characters per inch (cpi) in whole integers are supported. The condensed print flag, <code>-K</code>, is not supported.</p> <p><b>Font Name</b> Pitch</p> <p><b>-s courier</b> -p (1 to 100)</p> <p><b>-s courier-bold</b> -p (1 to 100)</p> <p><b>-s courier-italic</b> -p (1 to 100)</p> <p><b>-s courier-bolditalic</b> -p (1 to 100)</p> <p><b>-s gothic</b> -p (1 to 100)</p> <p><b>-s gothic-bold</b> -p (1 to 100)</p> <p><b>-s gothic-italic</b> -p (1 to 100)</p> <p><b>-s lineprinter</b> -p 17</p> <p><b>Note:</b> To format ASCII for other font styles, use the base operating system <b>enscript</b> utility or the <code>-da</code> flag to a PostScript queue with the <b>qp<code>prt</code></b> command. Only a pitch of 17 is supported for the lineprinter font style.</p>
<b>Collation</b>	<p>Normally, the <code>-N</code> command line option is used to specify the number of copies desired. This method will cause the specified number of copies of the entire print job to be submitted or queued to the print system. Because the Optra 410 supports collation internally, options were added to support it and the number of copies of each page internally. This functionality is limited by the amount of memory installed in your printer and the size of the job. The <code>-W #</code> option determines how many copies of each page is desired, where <code>#</code> is the number of copies. The <code>-S [!/+]</code> option controls whether collation is desired. The default is <code>!</code> (or not). The main advantages of using the <code>-W</code> and <code>-S</code> options are to conserve printer subsystem usage and allow the printer to handle multiple copies instead of sending <code>#</code> copies to the printer. Using the <b>-S!</b> options with the <code>-W #</code> also allows <code>#</code> copies of each page in a row, if this is desired. Note that using <code>-N</code> and <code>-W</code> simultaneously is allowed. This would result in <code>-N</code> print jobs with <code>-W</code> copies of each page in each job.</p>
<b>Separator Pages</b>	<p>The <code>-E</code> flag controls separator pages. The valid values are <b>0</b>, <b>1</b>, <b>2</b>, and <b>3</b>, which represent <b>NONE</b>, <b>BETWEENCOPIES</b>, <b>BETWEENJOBS</b>, and <b>BETWEENPAGES</b>, respectively. The separator page source defaults to TRAY 1 and is specified via the <b>uS</b> attribute. The valid values for <b>uS</b> are the same as for header and trailer pages (<b>uH</b> and <b>uT</b> respectively), except that the Manual Feeder is not supported. To change the default, the <b>uS</b> attribute must be changed in the virtual printer to one of the valid values (see the <b>chvirp<code>rt</code></b> command).</p>

# Lexmark Optra Se Laser Printer

Product specific information for the printer and queue system is provided.

Product specific information

---

Item	Descriptor
<b>Page Rotation</b>	<p>Page rotation selection is supported for the PCL 5e emulation by using the -z flag of the <b>qpri</b> command.</p> <ul style="list-style-type: none"><li><b>-z 0</b> Portrait</li><li><b>-z 1</b> Landscape</li></ul>
<b>Paper Source</b>	<p>Paper source selection is supported for both the enhanced PCL (R) 5e emulation and the PostScript Level 2 emulation by using the -u flag of the <b>qpri</b> command. There are several optional input sources (see your manual to determine which are installed). These numbers apply, no matter which ones are present. If one is not present, choosing one of those will simply default as per the user's manual. The input source number is the same for both PCL and PostScript:</p> <ul style="list-style-type: none"><li><b>-u 0</b> manual feed</li><li><b>-u 1</b> tray 1</li><li><b>-u 2</b> tray 2</li><li><b>-u 3</b> tray 3</li><li><b>-u 4</b> tray 4</li><li><b>-u 5</b> tray 5</li><li><b>-u 6</b> envelope feeder</li><li><b>-u 7</b> multipurpose tray</li></ul> <p>By default, the banner and trailer pages come from tray 1. To change the default, change the values for the <b>uH</b> and/or <b>uT</b> attributes, respectively, in the virtual printer to the value for the desired paper source. The valid values are the same as for the -u flag. Do this with the <b>chvipri</b> command.</p>

*(continued)*

Item	Descriptor
<b>Paper Size</b>	<p>Paper size selection is supported by using <code>-O</code> and <code>-Q</code> flags of the <b>qprt</b> command. The <code>-O</code> flag controls paper versus envelope. A <code>-O</code> value of 3 indicates a paper size and 4 an envelope size. The values 1 and 2 were skipped for backward compatibility. Envelopes are only valid for manual feed, envelope feeder, or the multipurpose tray. The default for <code>-Q</code> is 1 or Letter for paper sizes, and 3 or Com 10 for envelope sizes. To change the defaults, change the <b>s0</b> - <b>s7</b> attributes respectively for each of the valid input sources. Because manual feed and the multipurpose tray support both paper and envelopes, the default for paper is the <i>else</i> part (<code>%e1</code>), and the default for envelopes is the <i>then</i> part (<code>%t3</code>) of <b>s0</b> and <b>s7</b>.</p>
	<p><b>Paper Sizes (-O 3)</b> Envelope Sizes (-O 4)</p> <p><b>-Q 1 Letter</b> 7 3/4 Monarch</p> <p><b>-Q 2 Legal</b> 9 (Com 9)</p> <p><b>-Q 3 B5 (JIS B5)</b> 10 (Com 10)</p> <p><b>-Q 4 A4</b> DL</p> <p><b>-Q 5 Executive</b> C5</p> <p><b>-Q 6 A5</b> B5 Envelope</p> <p><b>-Q 7 Custom (Universal)</b> Other Envelope</p>
	<p><b>Note:</b> For PCL queues, if the selected size is not in the selected input source, a search sequence will be used to find the size requested. If the size is found, that source will be used. For PostScript queues, if the selected size is not in the selected input source, the printer will prompt the user to load the source with the appropriate size. This may result in an unexpected paper source being used or an op-panel message that may not make sense at first. See the manual to determine appropriate responses.</p>
<b>Paper Type</b>	<p>The Optra Se printers support paper types Plain Paper (default), Bond, Transparency, Card Stock, Labels, Letterhead, Preprinted, Colored Paper, Envelope (default for envelope feeder) and Custom Type <b>x</b>, where <b>x</b> can be 1 through 6. This colon file does not attempt to set these values and will use whatever the printer is set to for that input source. The user should insure that the proper paper type is actually installed in the specified source.</p>

*(continued)*

Item	Descriptor
<b>Pitch</b>	<p>Pitch selection is supported for the PCL 5 emulation by using the <code>-p</code> flag for pitch and the <code>-s</code> flag for font name (or type face) with the <b>qprt</b> command. Pitch values between 1 and 100 characters per inch (cpi) in whole integers are supported. The condensed print flag, <code>-K</code>, is not supported.</p> <p><b>Font Name</b> Pitch</p> <p><b>-s courier</b> -p (1 to 100)</p> <p><b>-s courier-bold</b> -p (1 to 100)</p> <p><b>-s courier-italic</b> -p (1 to 100)</p> <p><b>-s courier-bolditalic</b> -p (1 to 100)</p> <p><b>-s gothic</b> -p (1 to 100)</p> <p><b>-s gothic-bold</b> -p (1 to 100)</p> <p><b>-s gothic-italic</b> -p (1 to 100)</p> <p><b>-s lineprinter</b> -p 17</p> <p><b>Note:</b> To format ASCII for other font styles, use the base operating system <b>enscript</b> utility or the <code>-da</code> flag to a PostScript queue with the <b>qprt</b> command. Only a pitch of 17 is supported for the lineprinter font style.</p>
<b>Duplex Mode</b>	<p>The <b>qprt</b> command line option <code>-Y</code> supports this.</p> <p><b>0</b> simplex operation</p> <p><b>1</b> duplex, long edge binding</p> <p><b>2</b> duplex, short edge binding</p>
<b>Collation</b>	<p>Normally, the <code>-N</code> command line option is used to specify the number of copies desired. This method will cause the specified number of copies of the entire print job to be submitted or queued to the print system. Because the Optra Se supports collation internally, options were added to support it and the number of copies of each page internally. This functionality is limited by the amount of memory installed in your printer and the size of the job. The <code>-W#</code> option determines how many copies of each page is desired, where <code>#</code> is the number of copies. The <code>-S [!/+]</code> option controls whether collation is desired. The default is <code>!</code> (or not). The main advantages of using the <code>-W</code> and <code>-S</code> options are to conserve printer subsystem usage and allow the printer to handle multiple copies instead of sending <code>#</code> copies to the printer. Using the <code>-S!</code> options with the <code>-W#</code> also allows <code>#</code> copies of each page in a row, if this is desired. Note that using <code>-N</code> and <code>-W</code> simultaneously is allowed. This would result in <code>-N</code> print jobs with <code>-W</code> copies of each page in each job.</p>

Product specific information

(continued)

---

<b>Item</b>	<b>Descriptor</b>
<b>Separator Pages</b>	The -E flag controls separator pages. The valid values are <b>0</b> , <b>1</b> , <b>2</b> , and <b>3</b> , which represent <b>NONE</b> , <b>BETWEENCOPIES</b> , <b>BETWEENJOBS</b> , and <b>BETWEENPAGES</b> , respectively. The separator page source defaults to TRAY 1 and is specified via the <b>uS</b> attribute. The valid values for <b>uS</b> are the same as for header and trailer pages ( <b>uH</b> and <b>uT</b> respectively), except that the Manual Feeder is not supported. To change the default, the <b>uS</b> attribute must be changed in the virtual printer to one of the valid values (see the <b>chvirprt</b> command).
<b>Output Destination</b>	The -= (equal sign) is the command line option for specifying the output destination. Valid values are: <b>0</b> standard bin <b>1</b> bin 1 <b>2</b> bin 2 <b>3</b> bin 3 <b>50</b> active bin  The default value for the output destination is the standard bin ( <b>0</b> ). Note that if the active bin is selected, the printer will select the bin based on the state of output bin capacity sensing and the operator panel setting for <b>Configure Bins</b> under the <b>PAPER MENU</b> . See your printer manual to determine exactly how the printer will respond.

## Lexmark Optra T Laser Printer Family

Product specific information for the printers and queue systems is provided.

Product specific information

---

<b>Item</b>	<b>Descriptor</b>
<b>Page Rotation</b>	Page rotation selection is supported for the PCL 5e emulation by using the -z flag of the <b>qprt</b> command. <b>-z 0</b> Portrait <b>-z 1</b> Landscape

Product specific information

(continued)

---

<b>Item</b>	<b>Descriptor</b>
<b>Paper Source</b>	<p>Paper source selection is supported for both the enhanced PCL (R) 5e emulation and the PostScript Level 2 emulation by using the <code>-u</code> flag of the <b>qpri</b> command. There are several optional input sources (see your manual to determine which are installed). These numbers apply, no matter which ones are present. If one is not present, choosing one of those will simply default as per the user's manual. The input source number is the same for both PCL and PostScript:</p> <ul style="list-style-type: none"><li data-bbox="500 491 699 554"><b>-u 0</b> manual feed</li><li data-bbox="500 569 618 632"><b>-u 1</b> tray 1</li><li data-bbox="500 646 618 709"><b>-u 2</b> tray 2</li><li data-bbox="500 724 618 787"><b>-u 3</b> tray 3</li><li data-bbox="500 802 618 865"><b>-u 4</b> tray 4</li><li data-bbox="500 879 618 942"><b>-u 5</b> tray 5</li><li data-bbox="500 957 740 1020"><b>-u 6</b> envelope feeder</li><li data-bbox="500 1035 761 1098"><b>-u 7</b> multipurpose tray</li></ul>

By default, the banner and trailer pages come from tray 1. To change the default, change the values for the **uH** and/or **uT** attributes, respectively, in the virtual printer to the value for the desired paper source. The valid values are the same as for the `-u` flag. Do this with the **chvirprt** command.

*(continued)*

Item	Descriptor
<b>Paper Size</b>	<p>Paper size selection is supported by using <code>-0</code> and <code>-Q</code> flags of the <b>qprt</b> command. The <code>-0</code> flag controls paper versus envelope. A <code>-0</code> value of 3 indicates a paper size and 4 an envelope size. The values 1 and 2 were skipped for backward compatibility. Envelopes are only valid for manual feed, envelope feeder, or the multipurpose tray. The default for <code>-Q</code> is 1 or Letter for paper sizes, and 3 or Com 10 for envelope sizes. To change the defaults, change the <b>s0</b> - <b>s7</b> attributes respectively for each of the valid input sources. Because manual feed and the multipurpose tray support both paper and envelopes, the default for paper is the <i>else</i> part (<code>%e1</code>), and the default for envelopes is the <i>then</i> part (<code>%t3</code>) of <b>s0</b> and <b>s7</b>.</p>
	<b>Paper Sizes (-0 3)</b>
	Envelope Sizes (-0 4)
	<b>-Q 1 Letter</b> 7 3/4 Monarch
	<b>-Q 2 Legal</b> 9 (Com 9)
	<b>-Q 3 B5 (JIS B5)</b> 10 (Com 10)
	<b>-Q 4 A4</b> DL
	<b>-Q 5 Executive</b> C5
	<b>-Q 6 A5</b> B5 Envelope
	<b>-Q 7 Custom (Universal)</b> Other Envelope
	<p><b>Note:</b> For PCL queues, if the selected size is not in the selected input source, a search sequence will be used to find the size requested. If the size is found, that source will be used. For PostScript queues, if the selected size is not in the selected input source, the printer will prompt the user to load the source with the appropriate size. This may result in an unexpected paper source being used or an operator panel message that may not make sense at first. See the manual to determine appropriate responses.</p>
<b>Paper Type</b>	<p>The Optra T printers support paper types Plain Paper (default), Bond, Transparency, Card Stock, Labels, Letterhead, Preprinted, Colored Paper, Envelope (default for envelope feeder) and Custom Type <b>x</b>, where <b>x</b> can be 1 through 6. This colon file does not attempt to set these values and will use whatever the printer is set to for that input source. The user should insure that the proper paper type is actually installed in the specified source.</p>

*(continued)*

Item	Descriptor
<b>Pitch</b>	<p>Pitch selection is supported for the PCL emulation by using the <code>-p</code> flag for pitch and the <code>-s</code> flag for font name (or type face) with the <b>qprt</b> command. Pitch values between 1 and 100 characters per inch (cpi) in whole integers are supported. The condensed print flag, <code>-K</code>, is not supported.</p> <p><b>Font Name</b> Pitch</p> <p><b>-s courier</b> -p (1 to 100)</p> <p><b>-s courier-bold</b> -p (1 to 100)</p> <p><b>-s courier-italic</b> -p (1 to 100)</p> <p><b>-s courier-bolditalic</b> -p (1 to 100)</p> <p><b>-s gothic</b> -p (1 to 100)</p> <p><b>-s gothic-bold</b> -p (1 to 100)</p> <p><b>-s gothic-italic</b> -p (1 to 100)</p> <p><b>-s lineprinter</b> -p 17</p> <p><b>Note:</b> To format ASCII for other font styles, use the base operating system <b>enscript</b> utility or the <code>-da</code> flag to a PostScript queue with the <b>qprt</b> command. Only a pitch of 17 is supported for the lineprinter font style.</p>
<b>Duplex Mode</b>	<p>The <b>qprt</b> command line option <code>-Y</code> supports this.</p> <p><b>0</b> simplex operation</p> <p><b>1</b> duplex, long edge binding</p> <p><b>2</b> duplex, short edge binding</p>
<b>Collation</b>	<p>Normally, the <code>-N</code> command line option is used to specify the number of copies desired. This method will cause the specified number copies of the entire print job to be submitted or queued to the print system. Because the Optra T supports collation internally, options were added to support it and the number of copies of each page internally. This functionality is limited by the amount of memory installed in your printer and the size of the job. The <code>-W#</code> option determines how many copies of each page is desired, where <code>#</code> is the number of copies. The <code>-S [!/+]</code> option controls whether collation is desired. The default is <code>!</code> (or not). The main advantages of using the <code>-W</code> and <code>-S</code> options are to conserve printer subsystem usage and allow the printer to handle multiple copies instead of sending <code>#</code> copies to the printer. Using the <code>-S!</code> options with the <code>-W#</code> also allows <code>#</code> copies of each page in a row, if that is desired. Note that using <code>-N</code> and <code>-W</code> simultaneously is allowed. This would result in <code>-N</code> print jobs with <code>-W</code> copies of each page in each job.</p>

Product specific information

(continued)

---

<b>Item</b>	<b>Descriptor</b>
<b>Separator Pages</b>	The -E flag controls separator pages. The valid values are <b>0</b> , <b>1</b> , <b>2</b> , and <b>3</b> , which represent <b>NONE</b> , <b>BETWEENCOPIES</b> , <b>BETWEENJOBS</b> , and <b>BETWEENPAGES</b> , respectively. The separator page source defaults to TRAY 1 and is specified via the <b>uS</b> attribute. The valid values for <b>uS</b> are the same as for header and trailer pages ( <b>uH</b> and <b>uT</b> respectively), except that the Manual Feeder is not supported. To change the default, the <b>uS</b> attribute must be changed in the virtual printer to one of the valid values (see the <b>chvirprt</b> command).
<b>Output Destination</b>	The -= (equal sign) is the command line option for specifying the output destination. Valid values are: <b>0</b> standard bin <b>1</b> bin 1 <b>2</b> bin 2 <b>3</b> bin 3 <b>4</b> bin 4 <b>5</b> bin 5 <b>6</b> bin 6 <b>7</b> bin 7 <b>8</b> bin 8 <b>9</b> bin 9 <b>10</b> bin 10  The default value for the output destination is the standard bin ( <b>0</b> ).

## Lexmark Optra W810 Laser Printer

Product specific information for the printer and queue system is provided.

Product specific information

---

<b>Item</b>	<b>Descriptor</b>
<b>Page Rotation</b>	Page rotation selection is supported for the PCL 5 emulation by using the -z flag of the <b>qprt</b> command. <b>-z 0</b> Portrait <b>-z 1</b> Landscape

Product specific information

(continued)

---

Item	Descriptor
<b>Paper Source</b>	<p>Paper source selection is supported for both the enhanced PCL (R) 5 emulation and the PostScript Level 2 emulation by using the <b>-u</b> flag of the <b>qprt</b> command. There are several optional input sources (see your manual to determine which are installed). These numbers apply, no matter which ones are present. If one is not present, choosing one of those will simply default as per the user's manual. The input source number is the same for both PCL and PostScript:</p> <ul style="list-style-type: none"><li data-bbox="505 495 695 552"><b>-u 0</b> manual feed</li><li data-bbox="505 569 613 625"><b>-u 1</b> tray 1</li><li data-bbox="505 642 613 699"><b>-u 2</b> tray 2</li><li data-bbox="505 716 613 772"><b>-u 3</b> tray 3</li><li data-bbox="505 789 613 846"><b>-u 4</b> tray 4</li></ul> <p>By default, the banner and trailer pages come from the top tray. To change the default, change the values for the <b>uH</b> and/or <b>uT</b> attributes, respectively, in the colon file to the value for the desired paper source. The valid values are the same as for the <b>-u</b> flag. Do this by editing the virtual printer colon file with the <b>chvirprt</b> command.</p>

(continued)

---

Item	Descriptor
<b>Paper Size</b>	<p data-bbox="501 289 1463 380">Paper size selection is supported by using the <code>-Q</code> flag of the <b>qprt</b> command. The first five paper sizes are also numbered for backward compatibility. Whenever an invalid value for the input source is selected, it will be ignored.</p> <p data-bbox="501 401 1463 457">The default for <code>-0</code> is 3 or paper. The default for <code>-Q</code> is 1 or Letter for paper sizes and Monarch for envelope sizes.</p> <p data-bbox="501 478 651 504"><b>Paper Sizes</b></p> <p data-bbox="501 525 618 581"><b>-Q 1</b> Letter</p> <p data-bbox="501 602 613 659"><b>-Q 2</b> Legal</p> <p data-bbox="501 680 659 737"><b>-Q 3</b> B5 Paper</p> <p data-bbox="501 758 581 814"><b>-Q 4</b> A4</p> <p data-bbox="501 835 662 892"><b>-Q 5</b> Executive</p> <p data-bbox="501 913 581 970"><b>-Q 6</b> A5</p> <p data-bbox="501 991 581 1047"><b>-Q 7</b> B4</p> <p data-bbox="501 1068 581 1125"><b>-Q 8</b> A3</p> <p data-bbox="501 1146 732 1203"><b>-Q 9</b> Ledger (11x17)</p> <p data-bbox="501 1224 837 1281"><b>-Q 10</b> Universal (11.69x17.69)</p> <p data-bbox="501 1302 1463 1358">To change the defaults, change the <b>s0 -s5</b> attributes respectively for each of the valid input values. The default paper size is the <i>else</i> part (%e1).</p> <p data-bbox="501 1379 570 1404"><b>Note:</b></p> <ol data-bbox="501 1425 1463 1785" style="list-style-type: none"><li>1. Manual Feed and Tray 1 support sizes <code>-Q 1, 2, 3, 4, 5, 6, 7, 8, 9, 10</code> (Letter, Legal, B4, A4, Executive, A5, B4, A3, 11x17, Universal).</li><li>2. Trays 2, 3, and 4 support sizes <code>-Q 1, 2, 4, 7, 8, 9</code> (Letter, Legal, A4, B4, A3, 11x17).</li><li>3. The printer (and this colon file) defaults paper size to letter for the US and A4 for Europe.</li><li>4. An invalid paper size value for the selected input source will cause an error to be reported.</li><li>5. If the selected size is not in the selected input source, either wrong size or empty, a search sequence will be used to find the size requested. See the printer manual for assistance</li></ol>

(continued)

Item	Descriptor
<b>Pitch</b>	<p>Pitch selection is supported for the PCL 5 emulation by using the <code>-p</code> flag for pitch and the <code>-s</code> flag for font name (or type face) with the <b>qpri</b> command. Pitch values between 1 and 100 characters per inch (cpi) in whole integers are supported. The condensed print flag, <code>-K</code>, is not supported.</p>
	<p><b>Font Name</b> Pitch</p> <ul style="list-style-type: none"> <li><b>-s courier</b> -p (1 to 100)</li> <li><b>-s courier-bold</b> -p (1 to 100)</li> <li><b>-s courier-italic</b> -p (1 to 100)</li> <li><b>-s courier-bolditalic</b> -p (1 to 100)</li> <li><b>-s gothic</b> -p (1 to 100)</li> <li><b>-s gothic-bold</b> -p (1 to 100)</li> <li><b>-s gothic-italic</b> -p (1 to 100)</li> <li><b>-s lineprinter</b> -p 17</li> </ul>
	<p><b>Note:</b> To format ASCII for other font styles, use the base operating system <b>enscript</b> utility or the <b>qpri</b> command with the <code>-da</code>, <code>-s</code>, and <code>-p</code> flags to a PostScript queue. For PostScript queues, <code>-p</code> stands for point size and the valid list of fonts can be found in <code>/usr/lib/ps/fontmap</code>. Valid point sizes are any integer from 1 to 1008. Only a pitch of 17 is supported for the lineprinter font style.</p>
<b>Duplex Mode</b>	<p>The optional duplex feature is supported by the <code>-Y</code> flag of the <b>qpri</b> command. The default value is 0 or simplex mode.</p> <ul style="list-style-type: none"> <li><b>-Y 0</b> simplex</li> <li><b>-Y 1</b> duplex, long edge binding</li> <li><b>-Y 2</b> duplex, short edge binding</li> </ul>

(continued)

---

Item	Descriptor
<b>Collation and Number of copies</b>	<p>The optra W810 printer supports collation of multiple copies of a print job internally. This feature is controlled by the <code>-W</code> and <code>-S</code> flags of the <code>qprt</code> command.</p> <p><b>-S!</b> collation off</p> <p><b>-S+</b> collation on</p> <p><b>-W#</b> number of copies</p> <p><b>Note:</b></p> <ol style="list-style-type: none"><li>1. This function is independent of the <code>-N</code> flag of the <code>qprt</code> command. The <code>-N#</code> flag will cause the print job to be sent to the printer <code>#</code> times. The <code>-W#</code> flag will send the print job once, and <code>#</code> copies of the job will be printed.</li><li>2. The function is limited by the amount of memory installed in the printer and the size of the print job.</li></ol>
<b>Separator Pages</b>	<p>The printer supports internally generated separator pages. This feature is controlled by the <code>-E</code> flag of the <code>qprt</code> command.</p> <p><b>-E0</b> None</p> <p><b>-E1</b> Between Copies</p> <p><b>-E2</b> Between Jobs</p> <p><b>-E3</b> Between Pages</p> <p>The paper source defaults to Tray 1. To change the default, the <code>uS</code> attribute must be changed in the virtual printer. The valid values for <code>uS</code> are:</p> <p><b>uS 1</b> Tray 1</p> <p><b>uS 2</b> Tray 2</p> <p><b>uS 3</b> Tray 3</p> <p><b>uS 4</b> Tray 4</p> <p><b>Note:</b> This function is independent of the <code>-B</code> flag of the <code>qprt</code> command.</p>
<b>Finisher Stapes</b>	<p>The Optra W810 printer supports this option if it has an optional Finisher installed. The valid values for <code>y</code> are:</p> <p><b>-y 0</b> Off</p> <p><b>-y 1</b> On</p>

Product specific information

(continued)

---

<b>Item</b>	<b>Descriptor</b>
<b>Finisher Offset</b>	<p>The Optra W810 printer supports this option if it has an optional Finisher installed. The valid values for e are:</p> <ul style="list-style-type: none"><li><b>-e 0</b> Off</li><li><b>-e 1</b> On</li></ul>
<b>Hole Punch</b>	<p>The Optra W810 printer supports this option if it has an optional Finisher installed. The valid values for o are:</p> <ul style="list-style-type: none"><li><b>-o 0</b> Off</li><li><b>-o 1</b> On</li></ul>
<b>Output Destination</b>	<p>The -= (equal sign) is the command line option for specifying the output destination. Valid values are:</p> <ul style="list-style-type: none"><li><b>0</b> standard bin</li><li><b>1</b> bin 1</li><li><b>2</b> bin 2</li><li><b>3</b> bin 3</li><li><b>4</b> bin 4</li><li><b>5</b> bin 5</li><li><b>6</b> bin 6</li><li><b>7</b> bin 7</li><li><b>8</b> bin 8</li><li><b>9</b> bin 9</li><li><b>10</b> bin 10</li></ul> <p>The default value for the output destination is the standard bin (<b>0</b>).</p>

## Lexmark Plus Printer Models 2380-3, 2381-3, 2390-3, 2391-3

Product specific information for each printer and queue system is provided.

Product specific information

---

Item	Descriptor
<b>Paper Source</b>	<p>Paper source selection is supported by using the -u flag of the <b>qprt</b> command.</p> <p><b>-u 1</b> tractor 1</p> <p><b>-u 2</b> tractor 2</p> <p>The banner and trailer pages use the same source as the print job. It is suggested that the printer be attended when switching between tractors.</p>
<b>Pitch, Font, and Quality</b>	<p>Pitch selection is supported by using the -p flag for the pitch, the -s flag for font name, and -q flag of the <b>qprt</b> command for print quality. The default values supported include:</p> <p><b>10</b> pitch</p> <p><b>courier</b> font</p> <p><b>quality</b> 1 or draft</p>

(continued)

Item	Descriptor
	<p>The valid font values include:</p> <p><b>Font Name</b></p> <ul style="list-style-type: none"> <li>-s fast draft</li> <li>-s draft</li> <li>-s courier</li> <li>-s gothic</li> <li>-s prestige (239x only)</li> <li>-s presenter (239x only)</li> <li>-s orator (239x only)</li> <li>-s script (239x only)</li> </ul> <p>The valid quality values include:</p> <p><b>Quality (-q flag)</b></p> <ul style="list-style-type: none"> <li>0 fast draft</li> <li>1 draft</li> <li>2 near letter quality (238x only)</li> <li>2 letter quality (239x only)</li> <li>3 enhanced letter quality (239x only)</li> </ul> <p>The valid pitch values are 10, 12, 17, 20, and 24 for 239x only.</p> <p><b>Note:</b></p> <ol style="list-style-type: none"> <li>1. Selection of draft or fast draft will override the selected font.</li> <li>2. Bold font is supported using the -e flag and emphasized print. Italic font is supported using the -k flag and italic print.</li> </ol>
<b>Page Width</b>	<p>The -w flag controls the width of the printable page in characters.</p> <p><b>Plus Printer</b></p> <ul style="list-style-type: none"> <li>Default</li> <li><b>2380 and 2390</b> 80</li> <li><b>2381 and 2391</b> 136</li> </ul>

## OKI MICROLINE 801PS/+F, 801PSII/+F, 800PSIILT

Product specific information for each printer and queue system is provided.

The Japanese PostScript and ASCII data streams are supported. Japanese language text files cannot be printed. All OKI MICROLINE series printers are connected by RS-232C cabling.

## Printronix P9012 Line Printer

Product specific information for the printer and queue system is provided.

Only the Serial Matrix command set is supported. The P-series command set is not supported.

## QMS ColorScript 100 Model 20 Printer

The QMS ColorScript 100 Model 20 printer can print color PostScript files and HPGL (Hewlett-Packard Graphics Language) files.

The HPGL emulator is shipped on a DOS diskette with the printer. ASCII files can also be printed using the PostScript data stream.

To print PostScript files, do not enter a print queue name for the HPGL data stream when making the print queue. To print HPGL files, do the following:

1. Enter a print queue name for the HPGL data stream when making the print queue.
2. Insert the 3-1/2 inch diskette labeled HPGL Emulator in the diskette drive.
3. Make sure you are the root user.
4. Enter the following to copy the HPGL emulator files from the DOS diskette to the appropriate directory:

```
/usr/lib/lpd/pio/etc/pioqms100 -Q
```

When HPGL print files are submitted to the HPGL print queue, the system downloads the HPGL emulator to the printer and selects the emulator as needed.

PostScript files can also be submitted to the HPGL print queue. The files must begin with the two-character string **%!** so the system can recognize them as PostScript instead of HPGL files.

## Texas Instruments OmniLaser 2115 Page Printer

Product specific information for the printer and queue system is provided.

Automatic selection of the printer data stream (PostScript, HP LaserJet+, Diablo 630, TI 855, Plotter) is not supported. The data stream must be selected manually, using the control panel.

You can also print ASCII files using the PostScript data stream.

Only DP mode is supported for the TI 855 software interface. WP mode is not supported.

Each time the printer controller is turned on, enter the following:

```
sp1p -F! lpx
```

where *lpx* is the printer device name, such as **lp0**. This tells the system that the HPGL emulator needs to be downloaded to the printer again.

When you reboot the system, turn the printer off and on to reinitialize it.

## System V printer configuration

---

System V printer configuration differs in some respects from AIX printer configuration.

For more information on advanced print service functions, see the following two topics.

- [“Print filters” on page 230](#)

- “PostScript printers” on page 240

## System V print service

The System V print service is a collection of utilities that help you, as system administrator (or printer administrator), to configure, monitor, and control the printers on your system.

The print service does the following:

- Receives files users want to print
- Filters the files (if needed) so they can print correctly
- Schedules the work of one or more printers
- Starts programs that interface with the printers
- Keeps track of the status of jobs
- Alerts you to printer problems
- Keeps track of mounting forms and filters
- Issues error messages when problems arise

When a user sends a file to a printer, the print service assigns to the request (*print job*) a unique name, the *request ID*.

The request ID consists of the name of the printer on which the file is to be printed and a unique number identifying the file. Use this request ID to find out the status of the print job or to cancel the print job. The print service keeps track of all the print requests in the request log.

The print job is *spooled*, or lined up, with other print jobs to be sent to a printer. Each print job is processed and waits its turn in line to be printed. This line of pending print jobs is called a *print queue*.

Each printer has its own queue; you can hold jobs in the queue, move jobs up in a queue, or transfer jobs to another queue.

## Print request processing

Print requests are sent to a *spooling daemon* (background program) that keeps track of all of the print jobs.

As the following figure illustrates, each print request is sent to a *spooling daemon* (background program) that keeps track of all of the print jobs. (This information is archived in the request log.) The daemon is created when you start the print service. The spooling daemon is also responsible for keeping track of the status of the printers and slow filters; when a printer finishes printing a job, the daemon initiates printing another job if one is queued.

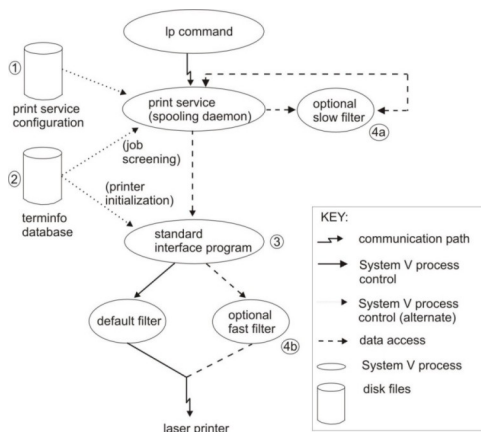

Figure 6. Overview of Print Request Processing

You can customize the print service by adjusting or replacing some of the items shown in the Overview of Print Request Processing figure (the numbers in the following list correspond to the numbered items in the diagram).

1. Print service configuration: For most printers, you need only change the printer configuration stored on disk. See the **lpadmin** command for adding or modifying a local printer.
2. **terminfo** database: For printers that are not represented in the **terminfo** database, you can add a new entry that describes the capabilities of the printer. See [“Adding a printer entry to the terminfo database” on page 225](#). The print service uses the **terminfo** database in two parallel capacities: screening print requests to ensure that those accepted can be handled by the desired printer, and setting the printer so it is ready to print the requests.

For example, if the **terminfo** database does not show a printer capable of setting a page length requested by a user, the spooling daemon rejects the request. However, if it does show it to be capable, then the interface program uses the same information to initialize the printer.

3. Standard Interface Program: If you have a particularly complicated printer or if you want to use features not provided by the print service, you can change the interface script. This script is responsible for managing the printer: it prints the banner page, initializes the printer, and invokes a filter to send copies of the user's files to the printer.
4. Optional filters: To provide a link between the applications used on your system and the printers, you can add slow and fast filters. Each type of filter can convert a file into another form, for example, mapping one set of escape sequences into another, and can provide a special setup by interpreting print modes requested by a user. Slow filters are run separately by the spooling daemon to avoid tying up a printer. Fast filters are run so their output goes directly to the printer; thus, they can exert control over the printer.

## Print request log

Each time a user sends a job to the printer, the print service creates two files that describe the job request and places one each in the `/usr/spool/lp/temp` and `/usr/spool/lp/requests` directories.

The information about the job is split into two files so that the system can keep sensitive information secure in the `/usr/spool/lp/requests` directory. The user who submitted the job has access to the request file in `/usr/spool/lp/temp`; only the printer administrator (or *root user*) has access to the file in `/usr/spool/lp/requests`.

The request files remain in these directories only while the job is in the queue. When the job finishes printing, the information in the two files is combined and appended to the request log, `/usr/spool/lp/logs/requests`.

The structure of the request log allows you to extract data using common shell commands. The requests are listed in the order in which they were printed, separated by lines that begin with the request ID. Each line below the separator line is marked with a single letter, the *request log code*, that identifies the kind of information contained in the line. Each letter is separated from the data by a single space. The table following the sample entry describes these codes.

Following is a sample entry from the print request log:

```
= ps-717, uid 1532, gid 18, size 7872, Tue May 10 14:43:10 1994
z ps
C 1
D ps
F /usr/spool/lp/temp/717-1
P 20
t simple
U hanna
s 0x0010
```

### Print request log entries

Letter	Content of line
=	The separator line lists the (comma-separated) request ID, user ID ( <b>uid</b> ), and group ID ( <b>gid</b> ) of the user who submitted the request, total number of bytes in the original (unfiltered) file ( <b>size</b> ), and the date and time the request was queued.
C	Number of copies printed.
D	Printer or class destination or the word any.
F	Name of the file in the /usr/spool/lp/temp directory. This line is repeated for each file printed, and files are printed in the order given.
f	Form name used (if applicable).
H	Type of special handling used: <ul style="list-style-type: none"> <li>• <b>resume</b></li> <li>• <b>hold</b></li> <li>• <b>immediate</b></li> </ul>
N	How the print service notified the user after printing the file (if applicable): <ul style="list-style-type: none"> <li>• <b>M</b> by an electronic mail message</li> <li>• <b>W</b> by a message written to the user's terminal</li> </ul>
O	Any -o options given to the <b>lp</b> command.
P	Priority of the print request, if applicable.
p	List of pages printed.
r	Any -r options given to the <b>lp</b> command indicating that the user requested raw processing of the file.
S	Character set used.
s	Outcome of the job, expressed as a combination of individual bits in hexadecimal form. The important bits used internally by the spooler are: <ul style="list-style-type: none"> <li>• <b>0x0004</b> Slow filtering finished successfully.</li> <li>• <b>0x0010</b> Printing finished successfully.</li> <li>• <b>0x0040</b> Request was canceled.</li> <li>• <b>0x0100</b> Request failed filtering or printing.</li> </ul>
T	Title on the banner page.
t	Content type of the file.
U	Name of the user who submitted the print request.
x	Slow filter.
Y	List of special modes to give to the filters used to print the request.
y	Fast filter.
z	Printer used for the request. This differs from the destination (the <b>D</b> line) if the request was queued for <i>any</i> printer or a class of printers, or if the printer administrator transferred the request to another printer.

## Print service commands

A summary of the print service commands available to all users is provided.

Command	Description
<u>cancel</u>	Cancel a request for a file to be printed
<u>lp</u>	Sends a file or files to a printer
<u>lpstat</u>	Reports the status of the print service

The administrator can give users the ability to disable and enable a printer so that if a printer is malfunctioning, the user can turn the printer off without having to call the administrator. (However, in your printing environment, it might not be reasonable to allow regular users to disable a printer.)

The Administrative Print Service Commands Table lists print service commands available only to the administrator. To use the administrative commands, you must be logged in as root user.

The administrative print service commands are located in the `/usr/lib` directory. If you use these commands frequently, include `/usr/lib` in your **PATH** variable.

### Administrative print service commands

Command	Description
<u>accept reject</u>	Permits jobs to be queued for a specified destination Prevents jobs from being queued for a specified destination
<u>cancel</u>	Cancel requests to a line printer
<u>enable disable</u>	Activates the named printers
<u>lpadmin</u>	Sets up or changes printer configurations
<u>lpc</u>	Provides (BSD) line printer control
<u>lpfilter</u>	Sets up or changes filter definitions
<u>lpforms</u>	Sets up or changes preprinted forms (use <code>/usr/sbin/lpadmin</code> to mount a form)
<u>lpmove</u>	Moves output requests from one destination to another
<u>lpsched lpshut</u>	Starts the print service Stops the print service
<u>lpssystem</u>	Registers remote systems with the print service
<u>lpusers</u>	Sets or changes the default priority and priority limits that the users of the print service can request

## Default printer page size and spacing

When a user submits a request to print a file, the page size, character pitch, and line pitch (spacing) are normally determined from the form that it is printed on.

If the user does not require a form, he or she can specify the page size and print spacing to use. If the user gives neither a form to use nor the page size and print spacing, defaults are used.

**Note:** The preceding information does not apply to PostScript printers.

By setting defaults for each printer, you can make it easier to submit print requests. For example, you can designate different printers as having different default page sizes or print spacing. You can dedicate one printer to printing wide (132-column) output, another to printing normal (80-columns, 66 lines) output, and yet another to printing letters in monospaced fonts (12 characters per inch, 8 lines per inch). Users simply route their file to the appropriate printer to get the style of output they want.

You can specify the following default settings:

- Page width
- Page length
- Character pitch
- Line pitch

Specify the first two in columns and lines respectively (or in inches). Specify character pitch and line pitch in characters per inch (cpi) and lines per inch (lpi) respectively.

In addition, specify the character pitch as **pica** for 10 cpi, **elite** for 12 cpi, or **compressed** for the maximum cpi the printer can provide (up to a limit of 30 cpi).

To specify the default settings, use the following commands:

```
/usr/sbin/lpadmin -p printer_name -o width=scaled-number
/usr/sbin/lpadmin -p printer_name -o length=scaled-number
/usr/sbin/lpadmin -p printer_name -o cpi=scaled-number
/usr/sbin/lpadmin -p printer_name -o lpi=scaled-number
```

**Note:** The **lpadmin** command uses the printer type to determine whether the settings are possible for the printer. Therefore, you must first set the printer type before you can specify these defaults.

For example, to specify a page width of 11 inches, a page length of 14 inches, character pitch to compressed, and line pitch of 3 lines per inch for the printer barney, enter:

```
/usr/sbin/lpadmin -p barney -o width=11i
/usr/sbin/lpadmin -p barney -o length=14i
/usr/sbin/lpadmin -p barney -o cpi=compressed
/usr/sbin/lpadmin -p barney -o lpi=3
```

If you do not provide defaults, the page size and print spacing are set to those available when the printer is initialized. You can determine what the defaults are by first defining the printer configuration without providing your own defaults, then using the **lpstat** command to display the printer configuration. To display the default page size and print spacing, enter:

```
lpstat -p printer_name -l
```

Information similar to the following displays:

```
Default pitch: compressed CPI 3 LPI
Default page size: Default page size: 11i wide 14i long
```

If you do not set the defaults, the **lpstat** command reports defaults from the **terminfo** database entry for the printer.

## Banner configuration

A banner is a page describing the print request (for example, printer name, user, date) that prints with the print job.

A *banner* is a page describing the print request (for example, printer name, user, date) that prints with the print job.

Use the following command to permit users to decide whether they want a banner printed:

```
/usr/sbin/lpadmin -o nobanner
```

## /etc/lp/Systems file administration

You can make connections to any system using BSD connections.

A default wildcard entry is supplied in the `/etc/lp/Systems` file that allows connections to any system using BSD connections. The wildcard entry is as follows:

```
*:x::-bsd:-:n:10:-::-:Allow all BSD connections
```

The presence of this entry allows a print server to accept connections from systems that are not explicitly configured as known systems.

Entries specifying the remote system name can still be added to the file using the **lpssystem** command.

Access to a printer can be controlled from the printer's `users.allow` and `users.deny` files. See the **lpadmin** command for more information.

**Note:** The wildcard entry is only used for incoming connection requests and not for outgoing requests.

If you do not want to separately control access to each printer on your system but you want the `/etc/lp/Systems` file to specify which remote systems have access to your printers, remove the wildcard entry from the file and add entries for the remote systems. To do this, perform the following:

- To remove the wildcard entry for BSD systems, use:

```
/usr/sbin/lpsystem -r "*"
```

- To add the entry for a specific remote system, use:

```
/usr/sbin/lpsystem system-name
```

## Printer models file

The printer models file `/usr/lib/scoadmin/printer/model.stz` contains a list of supported printers and their attributes.

The `/usr/lib/scoadmin/printer/model.stz` format is as follows:

```
key1:
```

```
attr1=val1
```

```
attr2=val2
```

```
key2:
```

```
...
```

The file includes a text description of each supported make and model, pointers to a printer interface script, and a **terminfo** entry. It can also contain additional information such as required serial line settings or supported content types.

The following attributes are available:

Item	Descriptor
<b>contents</b>	A quoted, comma-separated list of the content types supported for a printer, usually just <b>PS</b> (for postscript), <b>pcl</b> (for Hewlett-Packard's Printer Control Language), or <b>simple</b> (for most other printers). Additional content types can be supported by creating Print Filters. See <a href="#">“Print filters” on page 230</a> . This attribute is optional.

Item	Descriptor
<b>interface</b>	The Printer Interface Script should be set to <b>standard</b> in most cases. See <a href="#">“Printer interface scripts”</a> on page 221. This attribute is mandatory.
<b>name</b>	A text description of a printer make/model. This attribute is mandatory.
<b>terminfo</b>	Is the name of the <b>terminfo</b> entry associated with this printer. See <a href="#">“terminfo database”</a> on page 26. This attribute is optional.
<b>stty</b>	Any serial or parallel line settings appropriate for the printer. This attribute is optional.

In addition, each printer must have a unique key name associated with it, as shown in these examples:

```

canon-jet-10ex:
name="Canon Bubble Jet 10ex"
terminfo=bj-10ex
interface=standard

hp-laserjet:
name="HP LaserJet (PCL)"
terminfo=hplaserjet
interface=standard
contents=pcl
stty="clocal -onlcr"

```

## Printer interface scripts

A *printer interface script* is a program that the print service uses to manage the printer each time it prints a file. The interface script initializes the printer, takes advantage of its particular capabilities, prints the file, and reports any errors.

**Note:** If you have an interface program that you have used with the print service of an older UNIX system, it should still work. Be aware, though, that several `-o` options have been *standardized* and will be passed to every interface program. These options may interfere with similarly named options your interface program uses.

The printer interface scripts are associated with the printer model and are located in `/etc/lp/model`. For example, the printer interface script for a PostScript printer is called `/etc/lp/model/PS`. You can also create your own interface scripts or customize existing ones to suit your needs. See [“Creating printer interface scripts”](#) on page 222.

Interface scripts do the following:

- Initialize the printer port (the connection between the computer and the printer). The *standard* (`/etc/lp/model/standard`) interface script uses the **stty** command to initialize the printer port. See the **stty** command for more information.
- Initialize the physical printer (restore the printer to a normal state in case a previously printed file has left it in an unusual state), setting the character pitch, line pitch, page size, and character set requested by the user. The *standard* interface script uses the **lp.set** command to initialize the printer. See the **lp.set** command for more information.
- Print banner page (or pages), if required.
- Print the requested files. The *standard* interface script calls the **lp.cat** command to print the files. See the **lp.cat** command for more information.
- Report any errors to the print service. The *standard* interface script uses the **lp.tell** command to send descriptions of printer faults to the print service. The print service forwards that information as an alert to the print administrator. See the **lp.tell** command for more information.

The print service opens the printer port. The print service gives the printer port connection to the interface script as standard output and sets the printer to be the controlling terminal for the interface script. If the port experiences a hangup, a **SIGHUP** signal is sent to the interface script.

Many of the interface scripts provide special options that the user can specify by using the `-o` option with the **lp** command. See the **lp** command for more information.

The print service runs the interface script to send the print job to the printer, as shown in the following example:

```
/etc/lp/interfaces/printer id user title copies options file1 file2 ...
```

Arguments to the interface script are:

Item	Descriptor
<i>printer</i>	The name of the interface script (the same as the printer name).
<i>id</i>	Request ID returned by the <b>lp</b> command.
<i>user</i>	Login name of user who made the request.
<i>title</i>	Optional title specified by the user.
<i>copies</i>	Number of copies requested by the user.
<i>options</i>	List of blank-separated options, specified by the user (using <b>lp -o</b> ) or by the print service (from default values specified by the administrator with the <b>lpadmin</b> command). See the <b>lp</b> command for the list of options recognized by the <i>standard</i> interface.
<i>file</i>	Full path name of a file to be printed.

When the interface script is invoked:

- Standard input comes from `/dev/null`.
- Standard output is directed to the printer port.
- Standard error output is directed to a file that will be displayed to the user who submitted the print request.

The print service passes additional printer configuration information to the interface script as the following shell variables:

Item	Descriptor
<b>TERM=printer-type</b>	Specifies the printer type. The value is used as a key for obtaining printer capability information from the extended <b>terminfo</b> database.
<b>FILTER=pipeline</b>	Specifies the filter to use to send the request content to the printer; the filter is given control of the printer.
<b>CHARSET=character-set</b>	Specifies the character set to use when printing the content of a print request. The <i>standard</i> interface script extracts the control sequences needed to select the character set from the <b>terminfo</b> database.

## Creating printer interface scripts

If you have a printer that is not supported by adding an entry to the **terminfo** database, or if your printing needs are not supported by the *standard* or other interface scripts provided in the `/etc/lp/model` file, you can create your own printer interface script.

To create a customized interface script, do the following:

1. Modify the *standard* interface script (or one of the other scripts in `/etc/lp/model`). For example:

```
cd /etc/lp/model
cp standard okidatanew
```

2. Make sure that the custom interface script sets the proper **stty** modes (terminal characteristics such as baud rate or output options). Look for the section that begins with this line:

```
## Initialize the printer port
```

3. Modify the code in the standard interface script. It sets both the default modes and the adjusted modes given by the print service or the user with a line similar to the following:

```
stty mode options 0<&1
```

This command line takes the standard input for the **stty** command from the printer port. For example, the following **stty** command example sets the baud rate to 1200bps and sets some of the option modes:

```
stty -parenb -parodd 1200 cs8 cread clocal ixon 0<&1
```

4. Set the hardware-flow control printer-port characteristic. The standard interface script does not set hardware flow control; it is set according to your computer hardware. The code for the standard interface script suggests where to set this and other printer port characteristics. Look for the section that begins with this line:

```
# Here you may want to add other port initialization code.
```

5. Because different printers have different numbers of columns, make sure the header and trailer for your interface script correspond to your printer. The standard interface script prints a banner that fits on an 80-column page (except for the user's title, which may be longer). Look for the section in the code for the standard interface script that begins with this line:

```
## Print the banner page
```

6. Some applications, when run with certain printers, may require that you turn off page breaking. If you must turn off page breaking, you can modify the standard interface program (`/usr/lib/lp/model/standard`) at this line:

```
if [ -n "${FF}" -a "no" = "${nofilebreak}" ]
```

Change the **no** to **yes** to turn off page breaking.

7. Specify that the custom interface script print all user-related error messages to the standard output or to the standard error output. The print service prints standard output errors on the page and mails standard error to the user.
8. Specify that when printing is complete, the interface script exits with a code advising the status of the print job. The Exit Codes Table, “Print service exit codes” on page 224, describes how the print service interprets exit codes.

One way of alerting the administrator to a printer fault is to exit with a code of 129. Unfortunately, if the interface script exits, the print service reprints the print job from the beginning after the fault is cleared. To get an alert to the administrator without reprinting the entire job, specify that the interface script send a fault message to the print service, but wait for the fault to clear. When the fault clears, the interface script resumes printing the job. When the job finishes printing, the interface script can exit with zero as if the fault never occurred. An added advantage is that the interface script can detect when the fault is cleared automatically so that the administrator does not have to re-enable the printer.

To specify that fault messages be sent to the print service, use the **lp.tell** command. The standard printer interface code calls the **lp.tell** command with the `LPTELL` shell variable. The **lp.tell** program sends its standard input to the print service. The print service forwards the message as an alert to the administrator. If its standard input is empty, **lp.tell** does not initiate an alert. Examine the code immediately following these comments in the standard interface script for an example of how to use the **lp.tell** (`LPTELL`) program:

```
# Here's where we set up the $LPTELL program to capture  
# fault messages.
```

```
#  
# Here's where we print the file.
```

With the special exit code 129 or **lp.tell**, the interface script need not disable the printer itself. Your interface script can disable the printer directly, but doing so overrides the fault-alerting mechanism. Alerts are sent only if the print service detects that the printer has faulted, and the special exit code and **lp.tell** program are its main detection tools.

If the print service must interrupt the printing of a file at any time, it kills the interface script with a signal 15 (see the **signal** command and the **kill** command for more information).

If the interface script stops upon from receipt of any other signal, the print service assumes that future print jobs are not affected and continues to use the printer. The print service notifies the person who submitted the print job that the job did not finish successfully.

The signals **SIGHUP**, **SIGINT**, **SIGQUIT**, and **SIGPIPE** (trap numbers 1, 2, 3, and 13) are ignored when the interface is invoked. The standard interface script changes this to trap these signals at appropriate times, interprets these signals to mean that the printer has a problem, and issues a fault.

## Print service exit codes

The print service interprets a number of exit codes.

The following table describes how the print service interprets exit codes:

Code	Description
0	The print job completed successfully.
1 to 127	The print service encountered a problem in printing the job (for example, there were too many nonprintable characters or the job exceeded the printer's capabilities). This problem does not affect future print jobs. The print service should notify the person who submitted the print job, either via <b>write</b> or <b>mail</b> - that an error occurred in printing the job. If a printer fault occurred, it was cleared.
128	Reserved for internal use by the print service. Interface scripts must not exit with this code.
129	The print service encountered a printer fault in printing the job. This problem affects future print jobs. If the fault recovery for the printer directs the print service to wait for the administrator to fix the problem, the print service should disable the printer. If the fault recovery is to continue printing, the print service should not disable the printer, but try printing again in a few minutes.
> 129	Reserved for internal use by the print service. Interface scripts must not exit with codes in this range.

## Printer interface programs

By default, the print service uses the standard interface script, `/etc/lp/model/standard`. Use this interface script to handle most of your printing needs.

To change the interface script after you add the printer, you can specify an interface program using the `-i` option with the **lpadmin** command. See the **lpadmin** command for more information.

The following example adds a new printer called **laser** on printer port `/dev/tty01`. It uses a customized interface program, located in the directory `/usr/doceng/laser_interface`. It can handle three file types: **i10**, **i300**, and **impress**, and it can be used only by the users **doceng** and **docpub**. (The following command example is split into multiple lines for readability.)

```
lpadmin -p laser -v /dev/tty01 \  
-i /usr/doceng/laser_interface \  
-I "i10,i300,impress" \  

```

```
-u "allow:doceng,docpub"
```

## terminfo database

The print service relies on the standard interface script and the **terminfo** database to initialize each printer and set up a selected page size, character pitch, line pitch, and character set.

Thus, it is usually sufficient to have the correct entry in the **terminfo** database (`/usr/lib/terminfo/terminfo.lp`) to add a new printer to the print service.

The **terminfo** database identifies each printer by a short name, identical to the kind of name used to set the **TERM** shell variable. For example, the name in the **terminfo** database for the AT&T model 455 printer is **455**.

To specify the **terminfo** type for your printer, use the `-T` option of the **lpadmin** command. By default, the **terminfo** database includes entries for many popular printers. Select the **terminfo** type that corresponds to your printer.

If **terminfo** does not include an entry for your printer, you might still be able to use the printer with the print service. However, you will not be able to use automatic selection of page size, pitch, and character sets, and you might have trouble keeping the printer set to the correct modes for each print request or using printer forms with the printer. In this case, you can either add an entry to *terminfo* ([“Adding a printer entry to the terminfo database” on page 225](#)) for your printer or create a customized interface program ([“Creating printer interface scripts” on page 222](#)) to use with the printer.

You can define hundreds of items for each terminal or printer in the **terminfo** database. However, the print service uses fewer than 50 of these, and most printers need even less than that. You can check items defined for a specific **terminfo** entry by entering the following command:

```
infocmp terminfo_name
```

## Adding a printer entry to the terminfo database

You can create a **terminfo** entry for a printer.

To create a *terminfo* entry for your printer, do the following:

1. Identify an entry in the `/usr/lib/terminfo/terminfo.lp` file that uses the same commands as the printer you are adding and copy that information to *filename*, where *filename* is the file containing the *terminfo* entry you created for the printer.
2. Use the information in the manual for your printer, the [“terminfo entry definitions for printers” on page 225](#), and **terminfo** to modify the entry in *filename*.
3. After you create the new entry, compile it into the database, as follows:

```
tic filename
```

After adding or deleting **terminfo** entries or changing values that govern pitch settings, page width and length, or character sets, stop and restart the print service.

## terminfo entry definitions for printers

The following are the print service **terminfo** entries and their definitions:

<b>terminfo entry</b>	<b>Description</b>
<b>Booleans:</b>	
daisy	Printer needs operator to change character set
<b>Numbers:</b>	

<b>terminfo entry</b>	<b>Description</b>
bufsz	Number of bytes buffered before printing
* cols	Number of columns in a line
* it	Tabs initially every # spaces
* lines	Number of lines on a page
orc	Horizontal resolution in units per character
orhi	Horizontal resolution in units per inch
orl	Vertical resolution in units per line
orvi	Vertical resolution in units per inch
cps	Average print rate in characters per second

**Strings:**

* cr	Carriage return
cpi	Change number of characters per inch
lpi	Change number of lines per inch
chr	Change horizontal resolution
cvr	Change vertical resolution
csnm	List of character set names
mgc	Clear all margins (top, bottom, and sides)
* hpa	Horizontal position absolute
* cud1	Down one line
* cuf1	Carriage right
swidm	Enable double-wide printing
rwidm	Disable double-wide printing
* ff	Page eject
* is1	Printer initialization string
* is2	Printer initialization string
* is3	Printer initialization string
* if	Name of initialization file
* iprog	Path name of initializing program
* cud	Move carriage down # lines
* cuf	Move carriage right # columns
* rep	Repeat a character # times
* vpa	Absolute vertical position
scs	Select character set
smgb	Set bottom margin at current line
smgbp	Set bottom margin
* smgl	Set left margin at current column
smglp	Set left margin

terminfo entry	Description
* smgr	Set right margin at current column
smgrp	Set right margin
smgt	Set top margin at current line
smgtp	Set top margin
scsd	Start definition of a character set
* ht	Tab to next 8-space tab stop

The items marked with an asterisk (\*) are available on your system. The remainder of the definitions can be added.

## Printer forms

The print service includes facilities to create and administer forms.

A preprinted *printer form* is a blank paper form that you load into your printer. An application typically generates a file that, when printed on the blank form, fills out the form.

To specify the format of forms, create a form description file.

For example, create a file called `/tmp/check.desc` and include all or any subset of the following information:

```
Page length: 66
Page width: 80
Number of pages: 2
Line pitch: 10
Character pitch: 16
Character set choice: any
Ribbon color: blue
Comment:
    Check form
Alignment pattern:
    XXXX XXXXXXXXXXXXXXXX XXXXXXXXXXXX
    xxxxxx
    xxxxxxxxxxxxxxxxxxxxxxxxxxxxxxxxxxx
```

The print service uses the alignment pattern to line up the forms before printing begins and prompts you to perform an alignment before printing.

Depending on your printer, specify page length in lines, inches (i), or centimeters (c). Specify page width in columns, inches (i), or centimeters (c). In the example above, page length is specified as 66 lines. If the printer recognizes inches, specify the page length as 11i.

## Adding a form to the print service

You can add a form to the print service

After you have created a form, you must add it to the service. Choose a name that describes the form, because you use this name when you mount the form. The following command adds the `/tmp/check.desc` form:

```
lpforms -f check -F /tmp/check.desc
```

This command places the form in the `/usr/spool/lp/admins/lp/forms` file.

## Removing a form

The print service imposes no fixed limit on the number of forms you may define.

It is a good idea to remove forms that are no longer appropriate. If you do not, users must examine a long list of obsolete forms when choosing a form. In addition, because the print service must occasionally look through all the forms listed before performing certain tasks, the failure to remove obsolete forms may require unnecessary processing by the print service.

To remove a form, enter the following command:

```
/usr/sbin/lpforms -f form-name -x
```

## User access to forms

You can limit the availability of certain forms to selected users.

For example, you may want to limit access to checks to the people in the payroll department or accounts payable department.

The print service restricts the availability of a form by using the lists (provided by you) of users allowed or denied access to that form. If a user is not allowed to use a particular form, the print service will reject the request to print a file with it.

The method used to allow or deny users access to a form is similar to the method used to allow or deny users access to the **cron** and **at** facilities. See the [at](#), [cron](#), and [crontab](#) commands for more information.

If users on your system can access forms on a remote printer, all users included on the allow list for the local system must be included on the allow list for the remote system as well.

If, on the other hand, a local user is to be denied permission to use forms on a remote printer, it is not necessary for the deny lists in both the local and remote print services to include that user. By being included in only one of these deny lists, a user can be denied access to remote forms. As a courtesy to your users, however, make sure that any local users who are included in a deny list on a remote system are included in the corresponding deny list on your local system. This ensures that whenever a user on your system requests a form without authorization, the user is immediately informed that permission to use the form is being denied. If the local print service does not *know* that a user is denied permission to use a particular remote form, there will be a delay before the user receives a **permission denied** message from the remote system.

## Defining the forms access list

You can control user access to forms with the allow and deny lists.

To add names to the allow list and remove them from the deny list, run the following:

```
lpforms -f form-name -u allow:user-list
```

```
lpforms -f form-name -u deny:user-list
```

To add names to the deny list and remove them from the allow list, run the following:

The *user-list* is a comma- or space-separated list of names of users. If you use spaces to separate the names, enclose the entire list (including the **allow:** or **deny:** but not the **-u**) in quotes. Each item in the list can include a system name.

Specifying **allow:all** allows all users. Specifying **deny:all** denies all users.

If you do not add user names to the allow or deny lists, the print service assumes that all users may use the form.

## Mounting a form

Before the print service starts printing files that need a preprinted form, you must mount the form on a printer.

If alerting has been set on a form, you will be alerted when enough print requests are queued waiting for the form to be mounted (see [“Mount forms and font cartridge alerts”](#) on page 251 for information on alerting). Mounting a form involves loading it onto the printer and then informing the print service that it is mounted. It is sound practice to disable the printer first.

Until you have mounted a form on a printer, only print requests that do not require the form will be sent to the printer.

Use the following procedure to inform the print service that the form is mounted:

1. Disable the printer.
2. Load the new form onto the printer.
3. Run the following command to mount a form:

```
/usr/sbin/lpadmin -p printer-name -M -f form-name -a -o filebreak
```

4. Re-enable the printer.

If an alignment pattern has been registered with the form, you can ask that this be repeatedly printed after you have mounted the form, until you have adjusted the printer so that the alignment pattern looks correct.

The `-o filebreak` option tells the print service to add a form feed after each copy of the alignment pattern, if there is one. You must press the return key before each copy of the alignment pattern is printed.

The actual control sequence used for the form feed depends on the printer involved and is obtained from the **terminfo** database. If the alignment pattern already includes a form feed, omit the `-o filebreak` option.

## Examining a form

After you have defined a form to the print service, you can examine it with one of two commands, depending on the type of information you want to check.

The **lpforms** command displays the attributes of the form. (The display produced by the **lpforms** command can be used as input. You may want to save it in a file for future reference.) The **lpstat** command displays the current status of the form.

**Note:** A form definition that is captured in a file can be used later to redefine the form if you inadvertently remove the form from the print service.

To display the status of a form, run the following:

```
lpstat -f form-name -l
```

To receive a shorter version of the output, omit the `-l`.

The long form of output, an example of which follows, is similar to the output of **lpforms -l**:

```
Page length: scaled-number  
Page width: scaled-number  
Number of pages: integer  
Line pitch: scaled-number  
Character pitch: scaled-number  
Character set choice: character-set[,mandatory]  
Ribbon color: ribbon-color  
Comment:  
comment  
Alignment pattern: [content-type]  
content
```

To protect potentially sensitive content, the alignment pattern is not shown if the **lpstat** command is used.

## Print filters

A default filter is provided with the print service to provide simple printer fault detection. It does not convert files or handle any of the special modes. It may, however, be adequate for your needs.

A filter is a program that you can use for the following purposes:

- To convert a user file from one data format to another so that it can be printed correctly on a given printer
- To handle the special modes of printing that users may request with the **-y** option to the **lp** command (such as two-sided printing, landscape printing, draft or letter-quality printing)
- To detect printer faults and notify the print service of them, so that the print service can alert you

Not every filter can perform all three tasks. Given the printer-specific nature of these roles, the print service has been designed so that these roles can be implemented separately. This separation allows you or a printer manufacturer (or another source) to provide filters without having to change the print service.

**Note:** Adding, changing, or removing filters can cause print requests that are still queued to be canceled. This is because the print service evaluates all print requests still queued to see which are affected by the filter change. Requests that are no longer printable, because a filter has been removed or changed, are canceled (with notifications sent to the users who submitted them). There can also be delays in the responses to new or changed print requests when filters are changed, due to the many characteristics that must be evaluated for each print request still queued. These delays can become noticeable if there is a large number of requests that need to be filtered.

Because of this possible impact, make alterations to filters during periods when the print service is idle.

## File conversion

For each printer (local or remote), you can specify what file content types it can print.

When a user submits a file to print on any printer and specifies its content type, the print service finds a printer that can handle files of that content type. Because many applications can generate files for various printers, this is often sufficient. However, some applications generate files that cannot be printed on your printers.

By defining and creating a filter that converts such files into a type that your printers can handle, you can support more applications in the print service. (The print service provides a few filters for converting various types of files into PostScript.) For each filter you add to the system, you must specify one or more types of input it can accept and the type of output it can produce (usually only one).

When a user specifies (by executing **lp -T**) a file content type that no printer can handle, the print service tries to find a filter that can convert the file into an acceptable type. If the file to be printed is passed through a filter, the print service then matches the output type of that filter with a printer type or the input type of another filter. The print service continues to match output types to input types in this way, thus passing a file through a series of filters, until the file reaches a printer that accepts it.

### Example: HP DeskJet 500

In this example, the user Chris has run a spreadsheet program and has generated a file containing a copy of a spreadsheet. Chris now wants to print this file using the print service. You have only HP DeskJet 500 printers on your system. Fortunately, the spreadsheet application understands how to generate output for several printers, and Chris knows it is necessary to request output that can be handled by the HP DeskJet 500. When Chris submits the file for printing, the print service queues it for one of the printers; no filter is needed.

### Example: Tektronix 4014 Output

In this example, the user Marty created a graphic image that can be displayed on a Tektronix 4014 terminal. Marty now wants to print this image, but all of the printers are PostScript printers. Fortunately, your system provides a filter called **posttek** that converts Tektronix type files to PostScript. Because you set the printer type to PostScript, the print service recognizes that it can use the **posttek** filter to convert Marty's output before printing it.

## Special printing modes

Filters can handle special printing modes.

Each filter you add to the filter table can be registered to handle special modes and other aspects of printing, such as:

- Special modes
- Printer type
- Character pitch
- Line pitch
- Page length
- Page width
- Pages to print
- Character set
- Form name
- Number of copies

A filter is required to handle the special modes and printing of specific pages; the print service provides a default handling for the rest. However, it may be more efficient to have a filter handle some of the rest, or it is possible that a filter has to know several of these aspects to fulfill its other roles properly. A filter may need to know, for example, the page size and the print spacing if it is going to break up the pages in a file to fit on printed pages. As another example, some printers can handle multiple copies more efficiently than the print service, so a filter that can control the printer can use the information about the number of copies to skip the print service default handling of multiple copies.

## Printer fault detection

Just as converting a file and handling special printing modes is a printer-specific role, so is detecting printer faults.

The print service attempts to detect faults in general, and for most printers it can do so correctly. The range of faults that the print service can detect by itself, however, is limited. It can check for hang-ups (loss of carrier, the signal that indicates the printer is online) and excessive delays in printing (receipt of an XOFF flow-control character to shut off the data flow, with no matching XON to turn the flow back on). However, the print service cannot determine the cause of a fault, so it cannot inform you what to look for.

A well-designed filter can provide better fault coverage. Some printers are able to send a message to the host describing the reason for a fault. Others indicate a fault by using signals other than the dropping of a carrier or the shutting off of data flow. A filter can serve you by detecting more faults and providing more information about them than you would otherwise receive.

A filter can wait for a printer fault to clear and then resume printing. This service allows for more efficient printing when a fault occurs because the print request that was interrupted does not have to be reprinted in its entirety. Only a real filter, which has knowledge of the control sequences used by a printer, can *know* where a file breaks into pages. Thus only such a filter can find the place in the file where printing should resume.

The print service has an interface that allows a filter to send you fault information and to restart printing if it can. The alerting mechanism (see [“Printer fault alerts” on page 250](#)) is handled by the print service; the interface program that manages the filter takes all error messages from the filter and places them in an alert message that can be sent to you. If you have set the printer configuration so that printing should

automatically resume after a fault is cleared, the interface program keeps the filter active, so that printing can pick up where it left off.

### What Programs Make Good Filters

It is tempting to use a program such as **troff**, **nroff**, or a similar word-processing program as a filter. However, the **troff** and **nroff** programs have a feature that allows references to be made in a source file to other files, known as *include files*. The print service does not recognize include files; it will not enqueue any that are referenced by a source file when that file is in a queue to be printed. As a result, the **troff** or **nroff** program, being unable to access the include files, may fail. Other programs may have similar features that limit their use as filters.

Here are a few guidelines for evaluating a program for use as a filter:

- Only programs capable of reading data from standard input and writing data to standard output may be used as filters.
- Examine the kinds of files users will submit for printing that will require processing by the program. A good program is one that stands alone (that is, it does not need to refer to other files).

Determine if the program expects any files other than those submitted by a user for printing. If it does, those files must be in the directory of the person using the filter, or they must be readable by all users authorized to use the filter. The latter prerequisite is necessary because filters are run with the user ID and group ID of the user who submitted the print request.

- If referenced files are permitted in the files submitted for printing, or if the program will need files other than those submitted by a user, then the program, unable to access the additional files, is likely to fail. Rather than using the program under consideration as a filter; instead, have users run the program before submitting files for printing.

Referenced files that are always specified by full pathnames *may* be acceptable, but only if the filter is used for local print requests. When used on requests submitted from a remote machine for printing on your machine, the filter may still fail if the referenced files exist only on the remote machine.

### Print filter definition

When adding a new filter, you must define the characteristics of its use.

To defining the characteristics of a filter's use, issue the **lpfilter** command with arguments that specify the values of the following filter characteristics:

- Name of the filter (that is, a command name)
- Types of input it will accept
- Types of output it will produce
- Types of printers to which it will send jobs
- Names of specific printers to which it will send jobs
- Type of the filter (whether it is a **fast** filter or a **slow** filter)
- Options

See [“Adding a filter to the print service” on page 237](#) for more information.

Filter definitions, which can be stored in a file or entered directly on the command line, have the following format:

```
Command: command-pathname [options]  
Input types: input-type-list  
Output types: output-type-list  
Printer types: printer-type-list  
Printers: printer-list  
Filter type: fast or slow  
Options: template-list
```

The information can appear in any order. Not all of the information must be provided. When you do not specify values for the items listed below, default values are assigned.

<b>lpfilter Arguments</b>	<b>Default</b>
Command:	(no default)
Input types:	any
Output types:	any
Printer types:	any
Printers:	any
Filter type:	slow
Options:	(no default)

Default values define a flexible filter, so at minimum you must supply the input and output type(s). When you enter a list, you can separate the items in it with blanks or commas, unless it is a *template-list*. Items in a *template-list* must be separated by commas.

Each of these characteristics is described as follows:

- **Command:** The full path of the filter program.

If there are any fixed options that the program always needs, include them here.

- **Input types:** The list of file content types that the filter can process.

The print service does not impose a limit on the number of input types that can be accepted by a filter, but most filters can take only one. Several file types may be similar enough so that the filter can handle them. You can use any name having a maximum of 14 alphanumeric characters and dashes (not underscores). Because the print service uses these names to match a filter with a file type, follow a consistent naming convention. For example, if more than one filter can accept the same input type, use the same name for that input type when you specify it for each filter. Advise your users of the names so they know how to identify the type of a file when submitting that file for printing.

- **Output types:** The list of file types that the filter can produce as output.

For each input type, the filter produces a single output type. The output type may vary, however, from job to job. The names of the output types are restricted to 14 alphanumeric characters and dashes.

These names should either match the types of printers you have on your system or match the input types handled by other filters. The print service groups filters together in a shell pipeline if it finds that several passes by different filters are needed to convert a file. Try to find a set of filters that take (as input types) all the different files your users may want printed and converts those files directly into types your printers can handle.

- **Printer types:** A list of printer types into which the filter can convert files.

For most filters, this list is identical to the list of output types.

For example, you may have a printer that is given a single type for purposes of initialization (see “[Printer types](#)” on page 238), but which can recognize several different types of files. In essence, this printer has an internal filter that converts the various types into one that it can handle. Thus, a filter may produce one of several output types that match the *file types* that the printer can handle. Label the filter as working with that printer type.

As another example, you may have two different models of printers that are listed as accepting the same types of files. However, due to slight differences in manufacture, one printer deviates in the results it produces. You label the printers as being of different printer types, say A and B, where B is the one that deviates. You create a filter that adjusts files to account for the deviation produced by printers of type B. Because this filter is needed only for those printer types, you list it as working only on type B printers.

For most printers and filters, you can leave this part of the filter definition blank.

- **Printers:** You may have some printers that, although they are of the correct type for a filter, are in other ways not adequate for the output that the filter produces.

For example, you may want to dedicate one printer for fast turnaround. Only files that the printer can handle without filtering will be sent to that printer. Other printers, of identical type, you allow to be used for files that may need extensive filtering before they can be printed. In this case, label the filter as working with only the latter group of printers.

In most cases, a filter works with all printers that accept its output, so you can usually skip this part of the filter definition.

- **Filter type:** The print service recognizes *fast* filters and *slow* filters.

Fast filters are labeled fast because they incur little overhead in preparing a file for printing and because they must have access to the printer when they run. A filter that is to detect printer faults must be a fast filter. A filter that uses the **PRINTER** keyword as a filter option must be installed as a fast filter.

Slow filters are filters that incur a lot of overhead in preparing a file and do not require access to a printer. The print service runs slow filters in the background, without tying up a printer. This allows files that do not need slow filtering to move ahead. Printers will not be left idle while a slow filter works on a file if other files can be printed simultaneously.

Slow filters that are invoked by modes (using the `-y` option), must be run on the computer where the print request was issued. The print service cannot pass values for modes to server machines. It can, however, match a file content type (specified after the `-T` option of the `lp` command) to a content type on a server machine. Therefore, to activate special modes on a server machine, you must specify content types that will allow the print service to match input types and output types.

- **Options:** Options specify how different types of information is transformed into command line arguments to the filter command.

This information may include specifications from a user (with the print request), the printer definition, and the specifications implemented by any filters used to process the request.

There are 13 sources of information, each of which is represented by a *keyword*. Each option is defined in a *template*, which is a statement in the following format:

```
keyword pattern=replacement
```

This type of statement is interpreted by the print service to mean: "When the information referred to by *keyword* has the value matched by *pattern*, take the *replacement* string, replace any asterisks it contains with the *pattern* specified or expand any regular expressions it contains, and append the result to the command line."

The options specified in a filter definition may include none, all, or any subset of these 13 keywords. In addition, a single keyword may be defined more than once, if multiple definitions are required for a complete filter definition. See "[Option definition with templates](#)" on page 234.

When you have gathered enough information to define the characteristics of your filter, you are ready to run the `lpfilter` command, using your data as arguments. Because there are so many arguments and because some of them may need to be entered more than once (with different values), record this information first in a separate file and edit it, if necessary. You can then use the file as input to the `lpfilter` command and avoid entering each piece of information separately.

### **Option definition with templates**

A template is a statement in a filter definition that defines an option to be passed to the filter command based on the value of one of the characteristics of the filter.

A filter definition may include more than one template. Multiple templates may be entered on a single line and separated with commas, or they may be entered on separate lines, preceded by the **Options:** prefix.

The format of a template is as follows:

```
keyword pattern=replacement
```

This type of statement is interpreted by the print service to mean: "When the information referred to by *keyword* has the value matched by *pattern*, take the *replacement* string, replace any asterisks it contains

with the *pattern* specified or expand any regular expressions it contains, and append the result to the command line."

As an example, suppose you want to have the print service scheduler assign print requests to filters on the basis of the following criteria:

- If the type of **OUTPUT** to be produced by the filter is **impress**, then pass the -I option to the filter.
- If the type of **OUTPUT** to be produced by the filter is **postscript**, then pass the -P option to the filter.

To specify these criteria, provide the following templates as options to the **lpfilter** command:

```
Options: OUTPUT impress=-I, OUTPUT postscript=-P
```

If the **Options:** line becomes too long, put each template on a separate line, as follows:

```
"Options: OUTPUT impress=-I"
"Options: OUTPUT postscript=-P"
```

In both templates, the *keyword* is **OUTPUT**. In the first template, the value of *pattern* is **impress** and the value of the *replacement* is **-I**. In the second template, the value of *pattern* is **postscript** and the value of *replacement* is **-P**.

### Keyword definitions and examples

You can use keywords to define options in a filter definition.

The following *keywords* are available for defining options in a filter definition:

Characteristic	keyword	Possible patterns	Example
Content type (input)	INPUT	<i>content-type</i>	troff
Content type (output)	OUTPUT	<i>content-type</i>	postscript
Printer type	TERM	<i>printer-type</i>	att495
Printer name	PRINTER	<i>printer-name</i>	lp1
Character pitch	CPI	<i>scaled-decimal</i>	10
Line pitch	LPI	<i>scaled-decimal</i>	6
Page length	LENGTH	<i>scaled-decimal</i>	66
Page width	WIDTH	<i>scaled-decimal</i>	80
Pages to print	PAGES	<i>page-list</i>	1-5,13-20
Character set	CHARSET	<i>character-set</i>	finnish
Form name	FORM	<i>form-name</i>	invoice2
Number of copies	COPIES	<i>integer</i>	3
Special modes	MODES	<i>mode</i>	landscape

To find out which values to supply for each type of template (that is, for the *pattern* and *replacement* arguments for each *keyword*), consider the following:

- The values for the INPUT and OUTPUT templates come from the file type that needs to be converted by the filter and the output type that has to be produced by the filter, respectively. They will each be a type registered with the filter.
- The value for the TERM template is the printer type.
- The value for the PRINTER template is the name of the printer that will print the final output.
- The values for the CPI, LPI, LENGTH, and WIDTH templates come from the user request, the form being used, or the default values for the printer.

- The value for the PAGES template is a list of pages to be printed. Typically, it is a comma-separated list of page ranges, each of which consists of a dash-separated pair of numbers or a single number (such as **1-6,8,10** for pages 1 through 6, 8, and 10). However, whatever value was given in the -P option to a print request is passed unchanged.
- The value for the CHARSET template is the name of the character set to be used.
- The value for the FORM template is the name of the form requested by the -f option of the **lp** command.
- The value of the COPIES template determines the number of copies made of the file. If the filter uses this template, the print service will reduce to 1 the number of copies of the filtered file it will have printed, because this single copy will really be the multiple copies produced by the filter.
- The value of the MODES template comes from the -y option of the **lp** command (the command used to submit a print request). Because a user can specify several -y options, there may be several values for the MODES template. The values will be applied in the left-to-right order given by the user.

The *replacement* part of a template shows how the value of a template is given to the filter program. It is typically a literal option, sometimes with the place-holder **\*** (asterisk) included to show where the value goes. The *pattern* and *replacement* can also use the regular expression syntax of the **ed** command for more complex conversion of user input options into filter options. All of the regular expression syntax of the **ed** command is supported, including the **\( . . \)** and **\n** constructions, which can be used to extract portions of the *pattern* for copying into the *replacement*, and the **&**, which can be used to copy the entire *pattern* into the *replacement*.

**Note:** If a comma or an equal sign (=) is included in a *pattern* or a *replacement*, escape its special meaning by preceding it with a backslash (\). Note that some regular expressions include commas that will have to be escaped this way. A backslash in front of any of these characters is removed when the *pattern* or *replacement* is used.

#### *col filter example*

An example using col filter to modify a user's print requests is provided.

Suppose you already added a filter called **col** with the following definition:

```
Input types:      N37, Nlp, simple
Output types:    simple
Command:         /usr/bin/col
Options:         TERM 450 = -b, MODES expand = -x
Options:         INPUT simple = -p -f
```

**Note:** If you provide more than one definition (that is, more than one line) for any filter characteristic other than **Options**, only the last definition will be used by the print service.

After you have *registered* this definition with the print service by entering it as input with the **lpfilter** command, users' print requests will be handled as follows:

- If a user enters the command

```
lp -y expand report.dec10
```

the filter command will run with the following arguments:

```
/usr/bin/col -x -p -f
```

- If a user enters the command

```
lp -T N37 -y expand report.dec10
```

the filter command will run with the following arguments:

```
/usr/bin/col -x
```

Qualifier: The default printer is not of type 450.

- If a user enters the command

```
lp -y expand -T 450 report.dec10
```

the filter command will be run with the following arguments:

```
/usr/bin/col -b -x
```

#### *dpost filter example*

The filter program `/usr/lib/lp/postscript/dpost` takes one input type, troff, produces an output type called **postscript** and works with any printer of type PS (for PostScript).

You have decided that your users need to provide just the abbreviations **port** and **land** when they ask for the paper orientation to be portrait mode and landscape mode, respectively. Because these options are not intrinsic to the print service, users must specify them using the `-y` option to the `lp` command.

The filter definition would look like this:

```
Input types: troff
Output types: postscript
Printer types: PS
Filter type: slow
Command: /usr/lib/lp/postscript/dpost
Options: LENGTH * = -l*
Options: MODES portrait = -op, MODES land = -ol
```

A user submitting a file of type troff for printing on a PostScript printer (type **PS**), with requests for landscape orientation and a page length of 60 lines, would enter the following command:

```
lp -T troff -o length=60 -y land -d any
```

This filter would be invoked by the print service to convert the file as follows:

```
/usr/lib/lp/postscript/dpost -l60 -ol -pl
```

#### *Option template example*

Use this example as a template to convert a **MODES** option of the form `-y group=number` into filter options `-nnumber`.

You add the following option template to the example in the [“Option definition with templates”](#) on page 234 topic. See [“Option definition with templates”](#) on page 234 for more information.

```
Options: MODES group\=\([1-9]\) = -n\1
```

So if a user gives the command `lp -y group=4`, the **dpost** command would include the option `-n4`.

For additional examples, run the following command:

```
/usr/sbin/lpfilter -f filter -l
```

where *filter* is the name of the factory-installed PostScript filters. (For a list of PostScript filters, see [“PostScript printers”](#) on page 240.)

## Adding a filter to the print service

You can add a filter to the system after the filter is defined.

To add the filter to the system after it has been defined, use one of the following commands:

```
/usr/sbin/lpfilter -f filter-name -F filename
/usr/sbin/lpfilter -f filter-name -
```

The first command gets the filter definition from a file, and the second command gets the filter definition from the standard input. A *filter-name* can be any string you choose, with a maximum of 14 alphanumeric characters and underscores.

If you need to change a filter, reenter one of the same commands. You need provide information only for those items that must be changed. Items for which you do not specify new information remain the same.

## Removing a filter

The print service imposes no fixed limit on the number of filters you can define.

Remove filters that are no longer applicable to avoid extra processing by the print service, which must examine all filters to find one that works in a given situation.

To remove a filter, run the following command:

```
/usr/sbin/lpfilter -f filter-name -x
```

## Examining a filter

After you have added a filter definition to the print service, you can examine it by running the **lpfilter** command.

The output of the **lpfilter** command is the filter definition displayed in a format that makes it suitable as input. You may want to save this output in a file that you can use later to redefine the filter if you inadvertently remove the filter from the print service.

To present the definition of the filter on your screen, enter the following command:

```
/usr/sbin/lpfilter -f filter-name -l
```

To capture the definition of the filter in a file for future reference, enter the following command:

```
/usr/sbin/lpfilter -f filter-name -l > filename
```

## Restoring filter defaults

The software is shipped from the factory with a default set of filters. As you add, change, or delete filters, you might overwrite or remove some of these original filters.

To restore some or all of the default set of filters to their original form after having changed them, enter the following command:

```
/usr/sbin/lpfilter -f filter-name -i
```

Replace *filter-name* with the name of the filter to restore or the word **all** to restore all the default filters.

## Printer types

The **printer-type** attribute is defined with the **-T *printer-type*** option of the **lpadmin** command.

A printer type is the generic name for a printer. Typically it is derived from the manufacturer name. For example, the ACME\ Computer 356 Dot Matrix Printer might have the type **356**. Assigning a *type* for each printer is important because the print software extracts information about printers from the **terminfo** database on the basis of type. This information includes a list of the printer capabilities that checks the configuration information you supply to the print service. (By checking the information you provide against the known capabilities of the type of printer you are configuring, the print service can catch inappropriate information you may have supplied.) The **terminfo** database also specifies the control data needed to initialize a particular printer before printing a file.

While you are not required to specify a printer type, it is good practice to do so. You enhance your system's ability to serve your users by classifying, on the basis of type, the printers available through the print service.

If you give a list of printer types, separate the names with commas. If you do not define a printer type, the default **unknown** is used.

You can assign several types to a printer if your printer is capable of emulating more than one kind of printer. For example, if your printer can emulate an IBM Proprinter XL, an Epson FX86e, and an HP LaserJet II, the terminfo database names these types **593ibm**, **593eps**, and **593hp**, respectively. If you specify more than one printer type, the print service uses one of them, as appropriate, for each print request.

The following example shows how to use the **lpadmin** command to associate the type **593ibm** with the printer named **laser**.

```
/usr/sbin/lpadmin -p laser -T 593ibm
```

**Note:** If you specify more than one printer type, you must specify **simple** as the content type.

## Content types

Most printers can print files of the same type as the printer type and of the **simple** type (ASCII files).

The **content-type** attribute is defined with the `-I content-type-list` option of the **lpadmin** command. Most printers can print files of two types: the same type as the printer type (if the printer type is defined) and the type **simple** (meaning an ASCII file), which is the default content type for all printers.

Files of content type **simple** are assumed to contain only two types of characters, printable ASCII characters and the following control characters:

Item	Descriptor
<b>backspace</b>	Moves the carriage back one space, except at the beginning of a line
<b>tab</b>	Moves the carriage to the next tab stop; by default, stops are spaced every 8 columns on most printers
<b>linefeed</b>	Moves the carriage to the beginning of the next line (may require special port settings for some printers—see <a href="#">“Printer port characteristics” on page 252</a> )
<b>form feed</b>	Moves the carriage to the beginning of the next page
<b>carriage return</b>	Moves the carriage to the beginning of the same line (may fail on some printers)

The word *carriage* may be archaic for modern laser printers, but these printers perform actions similar to those done by a carriage. If a printer can handle several types of files, including **simple**, you must include **simple** explicitly in the content type list. If you do not want a printer to accept files of type **simple**, specify a blank *content-type-list* (`-I ""`) on the **lpadmin** command line. Some printers, though, can accept (and print correctly) several different types of files. When adding this kind of printer, specify the names of the content types that the new printer accepts by adding these names to the list. (By default, the list contains only one type: **simple**.) If you are adding a remote printer, list the content types that have been established for it by the administrator of the system on which it resides.

The *content-type-list* is a list of names separated by commas or spaces. If you use spaces to separate the names, enclose the entire list (except for the **-I**) in quotes.

### Common content types

Content types appear similar to printer type names, but you can choose names that are meaningful to people using the printer.

Content type names must contain no more than 14 characters and may include only letters, digits, and underscores. The following table lists and describes some accepted content types.

**Note:** The names **simple** and **any** are recognized as having particular meanings by the print service; be sure to use them consistently. The name **terminfo** is also reserved, as a reference to *all* types of printers.

### Commonly used content types

<b>Types</b>	<b>Description</b>
<b>cif</b>	Output of BSD <b>cifpbt</b>
<b>daisy</b>	Print files intended for a Diablo 630 ( <i>daisy-wheel</i> ) printer
<b>dmd</b>	Print the contents of a bit-mapped display from a terminal
<b>fortran</b>	ASA carriage control format
<b>otroff</b>	CAT typesetter instructions generated by BSD or pre-System V <b>troff</b> (old <b>troff</b> )
<b>pcl</b>	HP LaserJet native output format
<b>plot</b>	Plotting instructions for Tektronix displays and devices
<b>postscript</b>	PostScript language
<b>raster</b>	Raster bitmap format for Varian raster devices
<b>simple</b>	ASCII file
<b>tek4014</b>	Print files formatted for a Tektronix 4014 device
<b>tex</b>	DVI format files
<b>troff</b>	Device-independent output from <b>troff</b>

When a file is submitted to the print service for printing with the printer specified by the `-d` any option of the `lp` command, the print service searches for a printer capable of handling the job. The print service can identify an appropriate printer through either the content type name or the printer type name. Therefore, you may specify either name (or no name) when submitting a file for printing. If the same content type is printable by several different types of printers, use the same content type names when you add those printers. This makes it easier for the people using the printers because they can use the same name to identify the type of file they want printed, regardless of the printing destination.

Most manufacturers produce printers that accept simple ASCII files. While these printers are different types (and thus have different initialization control sequences), they may all be capable of handling the same type of file, which we call **simple**. Several manufacturers may produce printers that accept ANSI X3.64 defined escape sequences. However, the printers may not support all the ANSI capabilities; they may support different sets of capabilities. You may want to differentiate them by assigning different content type names for these printers.

### **Default content type**

While it may be desirable to list content types for each printer, it is not always necessary.

If you do not list the content types for a printer, the printer type is used as the name of the content type the printer can handle. If you have not specified a printer type, the print service assumes the printer can print only files of content type **simple**. This may be sufficient if you require users to specify the correct printer explicitly and if files are correctly prepared for the printer before being submitted for printing.

## **PostScript printers**

PostScript is a general-purpose programming language that allows you to specify the appearance of both text and graphics on a page.

A PostScript printer is equipped with a computer that runs an interpreter for processing PostScript language files. When a PostScript printer receives a file, it runs that file through the interpreter and then prints it. Unless special provisions have been made by the manufacturer, files submitted to a PostScript printer must be written in the PostScript language.

In addition to providing excellent facilities for managing text and graphics and combining them, most major applications that support printed output support PostScript. Graphics operators facilitate the construction of geometric figures that can then be positioned and scaled with any orientation. The text capabilities allow you to specify a number of different fonts that can be placed on a page in any position, size, or orientation. Because text is treated as graphics, text and graphics are readily combined.

Moreover, the language is resolution and device-independent, so that draft copies can be proofed on a low-resolution device and the final version printed in higher resolution on a different device.

Applications that support PostScript, including word-processing and publishing software, create documents in the PostScript language without intervention by the user. Thus, it is not necessary to know the details of the language to take advantage of its features. However, standard files that some applications or special terminals produce cannot be printed on a PostScript printer because they are not described in the language. The print service provides optional filters to convert many of these files to PostScript so that users can take advantage of PostScript and continue to use their standard applications, such as **troff**.

Retail Type 1 fonts can be installed for use with applications running on the desktop. These fonts can be downloaded to PostScript printers if the application generates PostScript output that uses them. The **lp** command handles this automatically using the **download** filter.

### Related information

[dslpaccept Command](#)  
[dslpaccess Command](#)  
[dslpadmin Command](#)  
[dslpdisable Command](#)  
[dslpenable Command](#)  
[dslpreject Command](#)  
[dslpsearch Command](#)  
[pstat Command](#)  
[mkprtldap Command](#)  
[mksecldap Command](#)

## Using a PostScript printer

When the PostScript printers and filters have been installed, the print service manages PostScript files like any others.

If **psfile** is a file containing a PostScript document and **psprinter** has been defined to the print service as a PostScript printer, the command

```
lp -d psprinter -T PS psfile
```

schedules the print request and manages the transmission of the request to the PostScript printer.

## Non-PostScript print requests

Because PostScript is a language and PostScript printers are expecting print requests written in that language, some applications may produce standard print requests that may not be intelligible to PostScript printers.

The following are examples of print requests that may not be interpreted by some PostScript printers.

### Non-PostScript content types

Content Type	Type of Print Request
<b>simple</b>	Print an ASCII ( <i>simple</i> ) text file
<b>troff</b>	Print output from the <b>troff</b> command
<b>daisy</b>	Print files intended for a Diablo 630 ( <i>daisy-wheel</i> ) printer
<b>dmd</b>	Print the contents of a bit-mapped display from a terminal
<b>tek4014</b>	Print files formatted for a Tektronix 4014 device
<b>plot</b>	Print plot-formatted files

Filters are provided with the print service to translate print requests with these formats to the PostScript language. For example, to convert a file containing ASCII text to PostScript code, the filter takes that text and writes a program around it, specifying printing parameters such as fonts and the layout of the text on a page.

After the PostScript filters are installed, they are invoked automatically by the print service when a user specifies a content type for a print request with the `-T` option. For example, if a user enters the command

```
lp -d psprinter -T simple report2
```

the ASCII file `report2` (a file with an `ASCII` or `simple` format) is converted to PostScript automatically, as long as the destination printer (`psprinter`) is defined to the system as a PostScript printer.

## Additional PostScript capabilities provided by filters

Additional PostScript capabilities can be provided by filters.

The filters described in “[Print filters](#)” on page 230 also take advantage of PostScript capabilities to provide additional printing flexibility. Most of these features can be accessed through the *mode option* (invoked by the `-y` option) to the `lp` command. These filters allow you to use several unusual options for your print jobs. The following list describes these options and shows the option to include on the `lp` command-line for each one:

Item	Descriptor
<code>-y reverse</code>	Reverse the order in which pages are printed
<code>-y landscape</code>	Change the orientation of a physical page from portrait to landscape
<code>-y x=number,y=number</code>	Change the default position of a logical page on a physical page by moving the origin
<code>-y group=number</code>	Group multiple logical pages on a single physical page
<code>-y magnify=number</code>	Change the logical size of each page in a document
<code>-o length=number</code>	Select the number of lines in each page of the document
<code>-P num_list</code>	Select, by page numbers, a subset of a document to be printed, where <i>num_list</i> is page numbers or page ranges separated by commas (for example, <b>1,4,6-8,14-</b> prints pages 1, 4, 6, 7, 8, and 14 through the end)
<code>-n number</code>	Print multiple copies of a document

**Note:** If these filters are to be used with an application that creates PostScript output, make sure that the format of the application conforms to the format of the PostScript file structuring comments. In particular, the beginning of each PostScript page must be marked by the comment

```
%%Page: label ordinal
```

where *ordinal* is a positive integer that specifies the position of the page in the sequence of pages in the document, and *label* is an arbitrary page label.

For example, you have a file called `report2` that has a content type **simple** (meaning that the content of this file is in ASCII format). You want to print six pages of this file (pages 4 through 9) with two logical pages on each physical page. Because one of the printers on your system (**psprinter**) is a PostScript printer, you can do this by entering the following command:

```
lp -d psprinter -T simple -P 4-9 -y group=2 report2
```

The filter that groups these logical pages will try to position the pages on the physical page to maximize space utilization. Thus, when you specify `group=2`, the pages will be printed side by side, so that the physical page will be landscape orientation. Landscape mode, which controls the orientation of the logical

page rather than the physical page, would cause the logical pages to be positioned one on top of the other when combined with the `group=2` option.

## PostScript printer support

PostScript printer support is similar to support of other printers.

PostScript printers must be defined to the system with the `lpadmin` command and the appropriate software must be installed to manage them. PostScript printers may require some additional effort in supporting fonts and establishing where *slow* filtering occurs.

### ***Installation and maintenance of PostScript printers***

PostScript printers, like other printers, are installed with the `lpadmin` command.

PostScript printers must use the PS interface program, requested by specifying `-m PS` on the `lpadmin` command line.

**Note:** The printer type and content type of a PostScript printer must be consistent with the printer type used in PostScript filters. Therefore, install your PostScript printers with a printer type of **PS**, **PS-b**, **PS-r**, or **PS-br**, and a content-type of **PS**.

The PS printer types serve two functions. First, they cause the print service to activate the correct fast filter to communicate with the printer. **PS** and **PS-r** are used to communicate with printers connected via a serial port; **PS-b** and **PS-br**, to communicate with printers connected through a parallel port. Second, the **PS** interface creates a PostScript banner page for PS printers. The banner page is printed last if the printer type is **PS-r** or **PS-br**, and the pages of the document are printed in reverse order. The printer type is specified with the `-T` option to the `lpadmin` command.

### ***PostScript Page order table***

You can choose the filtering of input by selecting a specific content type when configuring a PostScript printer.

<b>Printer</b>	<b>Connection Type</b>	<b>Page Order</b>
<i>PS</i>	serial	normal
<i>PS-b</i>	parallel	normal
<i>PS-r</i>	serial	reverse
<i>PS-br</i>	parallel	reverse

The **-b** specification (used when you select **PS-b** or **PS-br**) represents *batch*, which is typically used for parallel connections, but can also be used for serial connections if you do not want PostScript printer status messages. The **PS** and **PS-r** printer types cannot be used for parallel connections.

By specifying the `-I` option of the `lpadmin` command when configuring a PostScript printer, you can indicate which content types are handled by the printer without slow filtering. For a printer on a server system, **PS** is the correct content type to enter. However, for a printer on a client system, consider where slow filtering is to occur, because network and system resource management may be of concern.

By specifying valid content types other than **PS**, you can force the slow filtering of input to occur on the server system. Conversely, if you specify a content type of **PS**, the input will be filtered locally before the print request is forwarded to the server system for fast filtering and printing.

To configure a printer on a server system:

```
/usr/sbin/lpadmin -p ps1 -T PS-b -I PS -m PS
```

To configure a printer on a client system without local filtering:

```
/usr/sbin/lpadmin -p ps1 -T PS-b -I simple,daisy,dmd,tek4014,plot
```

To configure a printer on a client system with local filtering:

```
/usr/sbin/lpadmin -p ps1 -T PS-b -I PS
```

As part of the installation procedure, you may want to install fonts on the printer or downloadable fonts on the computer. See [“Installation and maintenance of PostScript fonts” on page 244](#) for details.

### ***Installation and maintenance of PostScript filters***

The PostScript filters provided cover the majority of situations. In certain circumstances, however, you may find it helpful to change the filter descriptions and install the filters differently.

This section describes the location and function of these filters. PostScript filters are contained in the directory `/usr/lib/lp/postscript`.

**Note:** There are two types of filters: fast filters and slow filters. For definitions of these types, see **lpfilter** and [“Print filter definition” on page 232](#).

A prerequisite of communication between any system and a PostScript printer is the presence of the **postio** or the **lp.cat** filter on the system. Those programs are the only mandatory PostScript filters that communicate directly with the PostScript printer. See [“PostScript filters” on page 244](#) for information on filters that allow other types of documents to be translated to PostScript and to be printed on a PostScript printer.

### ***PostScript filters***

A list of **file content types** and associated filters is provided.

<b>File Content Type</b>	<b>Filter</b>
<b>simple</b>	<b>postprint</b>
<b>troff</b>	<b>dpost</b>
<b>daisy</b>	<b>postdaisy</b>
<b>dmd</b>	<b>postdmd</b>
<b>tek4014</b>	<b>posttek</b>
<b>plot</b>	<b>postplot</b>

See [“Special-purpose PostScript filters” on page 244](#) for information on filters perform special functions.

### ***Special-purpose PostScript filters***

A list of special-purpose filters and their functions is provided.

<b>Function</b>	<b>Filter</b>
Communicate with printer	<b>postio,lp.cat</b>
Download fonts	<b>download</b>
Reverse or select pages	<b>postreverse</b>
Matrix gray scales	<b>postmd</b>

### ***Installation and maintenance of PostScript fonts***

One of the advantages of PostScript is its ability to manage fonts. Fonts are stored in outline form in the Type 1 format, either on the printer or on a computer that communicates with a printer.

When a document is printed, the PostScript interpreter generates each character as needed (in the appropriate size) from the outline description of it. If a font required for a document is not stored on the printer being used, it must be transmitted to that printer before the document can be printed. This transmission process is called *downloading fonts*.

Fonts are stored and accessed in several ways.

- Fonts may be stored permanently on a printer. These *printer-resident* fonts may be installed in ROM on the printer by the manufacturer. If the printer has a disk, fonts may be installed on that disk by you (that is, by the Print Service administrator). Most PostScript printers are shipped with 35 standard fonts, although less expensive models have only 13.
- A font may be *permanently downloaded* by being transmitted to a printer using a special PostScript programming technique using the **exitserver** operator. A font downloaded in this way will remain in the printer memory until the printer is turned off. Memory allocated to this font will reduce the memory available for PostScript print requests. Use of **exitserver** programs requires the printer system password and may be reserved for the printer administrator. This method is useful when there is continual use of a font by the majority of print requests serviced by that printer.
- Fonts may be prepended to a print request by the user and be transmitted as part of the user print request. When the document has been printed, the space allocated to the font is freed for other print requests. The font is stored in the user's directory. This method is preferable for fonts with limited usage.
- Fonts may be stored on a system shared by many users. These fonts may be described as *host-resident*. This system may be a server for the printer or may be a system connected to the printer by a network. Each user may request fonts in the document to be printed. This method is useful when there are a large number of available fonts or when there is not continual use of these fonts by all print requests. If the fonts will be used only on printers attached to a server, store them on the server. If the fonts are to be used by users on one system who may send jobs to multiple printers on a network, store them on the users' system.

The print service provides a special download filter to manage fonts using the last method in the list.

The print service can use **troff** width tables for the 35 standard PostScript fonts that reside on many PostScript printers, for use by the **dpost** program.

### ***Obtaining a list of printer-resident fonts***

Most PostScript printers come equipped with fonts resident in the printer ROM. Some printers have a disk on which additional fonts are stored.

A list of the Type 1 fonts in ROM or on disk of an attached PostScript printer can be obtained from the printer manufacturer's documentation. For PostScript printers attached through a serial port, a list of these fonts can also be generated using the **postio** command and a PostScript program, **romfonts.ps**.

To obtain a list of printer-resident fonts for a PostScript printer attached to a serial port, do the following:

1. Obtain the device on which the PostScript printer is connected:

```
lpstat -v
```

Given a system on which the PostScript printer **prlocal** is attached through a serial port, this command would return output similar to the following:

```
device for prlocal: /dev/tty01
```

This output shows the printer to be attached on device `/dev/tty01`.

2. As *root user*, run the following command:

```
cd /usr/lib/lp/postscript
```

3. As *root user*, run the following command:

```
postio -L /tmp/postio.o -l /dev/tty01 -t romfonts.ps
```

For our sample **prlocal** printer, this will produce output in the file `/tmp/postio.o` that looks similar to the following:

```
printer startup
%%[ status: waiting; source: serial 25 ]%%
%%[ status: endofjob ]%%
%%[ status: idle ]%%
```

```

sending file romfonts.ps
waiting for end of job
%%[ status: busy; source: serial 25 ]%%
/AGaramond-Bold
/AGaramond-BoldItalic
/AGaramond-Italic
/AGaramond-Regular
/AvantGarde-Book
/AvantGarde-BookOblique
/AvantGarde-Demi
/AvantGarde-DemiOblique
. . . more PostScript font
names . . .
/ZapfChancery-MediumItalic
/ZapfDingbats
%%[ status: endofjob ]%%
job complete

```

This example lists the printer-resident fonts for the **prlocal** printer.

### ***Adding printer-resident fonts to a printer's font list***

You can add printer-resident fonts to a printer's font list.

When a printer is installed, the list of printer-resident fonts should be added to the font list for that printer. This font list file can be edited to contain only the font names in the printer's memory (For example AGaramond-Bold through ZapfDingbats), and placed into the file `/etc/lp/printers/prlocal/residentfonts` to prevent downloading of these fonts from the host computer.

To add printer-resident fonts to a printer's font list, do the following:

1. Navigate to the printer administration directory in which the font lists are kept. For a particular printer, this font list is contained in the file `/etc/lp/printers/printer-name/residentfonts`.  
With the `-p` option, **download** checks this file to see what Type 1 fonts are ROM-resident and disk-resident (some PostScript printers have directly attached fonts disks) in the printer so that it does not download such fonts.
2. This file is not automatically created when a PostScript printer is first set up on your system using the **lpadmin** command. You may need to create this file yourself. (font-list files must be edited manually; that is, with the help of a text editor such as **vi**.)

When fonts are permanently downloaded to the printer, add the font names to this file. (This will prevent fonts from being downloaded when they are already on the printer, which can be a time-consuming procedure.)

**Note:** If the printer is attached to a remote system, this list should include fonts which reside on that system and are available for downloading to the printer. This prevents fonts from being transmitted unnecessarily across a network.

### ***Installing and maintaining host-resident fonts***

Some fonts will be resident on the host and transmitted to the printer as needed for particular print requests.

As the administrator, it is your job to make PostScript fonts available to all the users on a system. To do so, you must know how and where to install these fonts, using the guidelines described previously. Because fonts are requested by name and stored in files, the print service keeps a map file that shows the correspondence between the names of fonts and the names of the files containing those fonts. Both of these must be updated when fonts are installed on the host.

To install host-resident PostScript fonts, do the following:

1. Copy the font file to the appropriate directory. The fonts available for use with PostScript printers reside in the `/usr/share/lib/hostfontdir` directory or other directories.
2. Add to the map table the name of the font and the name of the file in which it resides. Also in the `hostfontdir` directory, you (the administrator) must create and maintain a map table that shows the correspondence between the name assigned to each font by the foundry (the company that created the font) and the name of the file in which that font resides. A file name that begins with a slash (/) is

used as is; otherwise, the pathname is relative to the host font directory. Comments in the map table are introduced by **%** (as in PostScript) and extend to the end of the line. For example, to map the font called *Palatino Bold*, add the following line to the map table:

```
Palatino-Bold /usr/share/lib/hostfontdir
```

(The map table itself is in the `/usr/share/lib/hostfontdir/map` file.)

After this entry exists in the map table on your system, your users can use a Palatino Bold font in their print jobs. When they submit for printing a file containing a request for this font, the print service will prefix a copy of the file `/usr/share/lib/hostfontdir` to that file before sending it to the printer, as long as it is not defined in the `residentfonts` file.

3. If you will be using **troff**, you must create new width tables for this font in the standard **troff** font directory.

### **Host-resident font downloads**

When the PostScript document contains a request for fonts not loaded on the printer, the **download** filter manages this request.

The download filter is invoked as a fast filter; it downloads fonts automatically if the fonts reside on the same system as the printer. The **download** filter may also send fonts to a remote printer. To do this, you can create a new filter table entry that calls the **download** filter as a slow filter through the `-y` option. Alternatively, you may force selection of this filter by changing the input type.

The **download** filter does the following:

- It searches the PostScript document to determine which fonts have been requested. These requests are documented with the following PostScript structuring comments in the header comments:

```
%%DocumentFonts: font1 font2 . . .
```

- It searches the list of fonts resident on that printer (in `/etc/lp/printers/printer-name/residentfonts`) to see if the requested font must be downloaded.
- If the font is not resident on the printer, it searches the host-resident font directory to see if the requested font is available. The only candidates for downloading are fonts listed in the map table that point *download* to readable files. A Type 1 font is downloaded once, at most, for a single document, even if it occurs multiple times in the `%%DocumentFonts:` comment or PostScript file. The downloading of fonts occurs only for the duration of the PostScript job. However, permanent downloading of fonts to the printer's RAM can be done with special PostScript programming techniques using the **exitserver** operator.

Requests for unlisted fonts or inaccessible files are ignored. All requests are ignored if the map table cannot be read.

- If the font is available, the filter takes the file for that font and prefixes it to the file to be printed.
- The filter sends the font definition file and the PostScript source file (the file to be printed) to the PostScript printer.

### **Font cartridges and character sets**

You can specify which font cartridge or character set is available with each printer.

Printers differ in the way they print different font styles. Some have font cartridges, while others have preprogrammed, selectable character sets. The print service can minimize the impact of these differences on the users of the print service.

When you list the font cartridges or character sets available, you assign names to them. These names are for your convenience and the convenience of the users on your system. Because different printers might have similar font cartridges or character sets, use common font names on all printers. This allows a user to submit a file for printing and request a particular font style, without requiring that the user know which printer is used or whether a font cartridge or selectable character set is used.

If the printer has mountable font cartridges, you need to list only their names. If the printer has selectable character sets, you must list their names and map each set to a name or number that uniquely identifies the set in the **terminfo** database.

### Specifying character sets

For printers that allow selectable character sets, determine the names of the character sets and then map each set to a name or number in the **terminfo** database.

- To determine the names of the character sets listed in the **terminfo** database, enter:

```
tput -T printer-type csnm 0
```

The *printer-type* is the name of the printer type in question. This command should display the name of the 0th character set (the character set obtained by default after the printer is initialized).

To display the names of the other character sets, repeat the command above, replacing 0 with 1, 2, 3, and so on. In general, the **terminfo** names should closely match the names used in the user documentation for the printer. However, because not all manufacturers use the same names, the **terminfo** names may differ from one printer type to the next.

- To specify a list of character set names and to map them into **terminfo** names or numbers, enter:

```
/usr/sbin/lpadmin -p printer_name -S characterset_list
```

The *characterset\_list* is a list of names, separated by commas or spaces. If you use spaces to separate the names, enclose the entire list (but not the -S) in quotes. Each item in the list is a character set name *mapping* (alias) that looks like one of the following:

```
csN=characterset_name  
characterset_name1=characterset_name2
```

The variable *N* is a number between 0 and 63 that identifies the number of the character set in the **terminfo** database. *characterset\_name1* identifies the character set by its name in the **terminfo** database. In both instances, the name to the right of the equal sign (=) is the name you choose as an alias of the character set.

**Note:** You do not have to provide a list of aliases for the character sets if the **terminfo** names are adequate. You can refer to a character set by **terminfo** name, by number, or by your alias.

For example, your printer has two selectable character sets (sets #1 and #2) in addition to the standard character set (set #0). The printer type is **5310**. Enter the following commands to determine the names of the selectable character sets:

```
tput -T 5310 csnm 1english
```

```
tput -T 5310 csnm 2finnish
```

The words *english* and *finnish*, which are the names of the selectable character sets, are the output of the commands. The name *finnish* is adequate for referring to character set 2, but better names are needed for the standard set (set 0) and set 1. Enter the following command to define synonyms:

```
/usr/sbin/lpadmin -p printer_name -S "cs0=american, english=british"
```

The following three commands will then produce identical results. (The **lp** command routes print jobs to the printer, and in these examples, routes the print job to any printer capable of handling the **cs1** character set.)

```
lp -S cs1 -d any . . .
```

```
lp -S english -d any . . .
```

```
lp -S british -d any . . .
```

If you do not list the character sets that can be used with a printer, the service assumes a printer that has selectable character sets can take any **csN** name or **terminfo** name known for the printer.

- To remove the character set mappings, enter:

```
/usr/sbin/lpadmin -p printer_name -S none
```

### ***Specifying font cartridges to use with a printer***

Until you specify the font cartridges that can be used with a new printer, the print service does not consider any font cartridges installable on that printer and rejects any print requests that require a font cartridge.

- To specify a list of font cartridges to use with a printer, type:

```
/usr/sbin/lpadmin -p printer_name -S font_cartridge_list
```

*font\_cartridge\_list* is a list of font cartridge names, separated by commas or spaces. If you use spaces to separate the names, enclose the entire list (but not the -S) in quotes. These are the only font cartridges considered installable on the printer.

- To remove the font cartridge list from the printer, enter:

```
/usr/sbin/lpadmin -p printer_name -S none
```

After you specify the list of font cartridges installable on the printer, you can install them. See [“Changing a font cartridge on a printer”](#) on page 249.

#### *Changing a font cartridge on a printer*

Before the print service prints a file that requires a font cartridge, you must install and mount the font cartridge on the printer.

If you have set up alerting for the font cartridge, the print service alerts you when enough print jobs are queued for the font cartridge to be installed and mounted. See [“Mount forms and font cartridge alerts”](#) on page 251 for more information.

Changing a font cartridge involves first removing the current font cartridge from the printer. Then, install the new font cartridge on the printer and inform the print service that the new font cartridge is ready to use by mounting it. Because it is difficult to do this on a printer that is currently printing and because the print service continues to print files that do not require the font cartridge on the printer, disable the printer first.

To install or change a font cartridge, do the following:

1. Disable the printer.
2. Remove the current font cartridge from the printer (if applicable).
3. Install the new font cartridge on the printer.
4. Mount the new font cartridge by entering:

```
/usr/sbin/lpadmin -p printer_name -M -S font_cartridge_name
```

Any print requests that require a font cartridge are printed on *printer\_name*.

5. Re-enable the printer.

To unmount a font cartridge, enter:

```
/usr/sbin/lpadmin -p printer_name -M -S none
```

**Note:** You do not need to unmount the current font cartridge after physically removing it from the printer before installing and mounting a new font cartridge.

## Printer fault alerts

The print service provides a method for detecting and alerting you to printer faults.

Faults can range from simple problems, such as running out of paper, ribbon, or toner, to more serious faults, such as a local power failure or printer failure. The range of fault indicators is also broad, ranging from dropping the carrier (the signal that indicates that the printer is online) to sending an XOFF or a message.

The print service itself only recognizes two classes of printer fault indicators: *hangups* (a loss of carrier) and excessive delays in printing (an XOFF flow-control character without a matching XON). For faults other than these, the printer service cannot determine the cause of the fault, so it cannot alert you. However, you can add filters that can detect other printer faults and inform the print service, which in turn alerts you. For more information, see [“Print filters” on page 230](#).

### Issuing a printer fault alert

To arrange for the print service to issue an alert in the event of a printer fault, enter one of the following commands:

- ```
/usr/sbin/lpadmin -p printer-name -A mail -W minutes
```
- ```
/usr/sbin/lpadmin -p printer-name -A write -W minutes
```
- ```
/usr/sbin/lpadmin -p printer-name -A 'command' -W minutes
```

The first two commands direct the print service to send you a mail message or write the message directly to your terminal, respectively, for each alert. The third command directs the print service to run the *command* command for each alert. The shell environment currently in effect when you enter the third command is saved and restored for the execution of *command*. The environment includes environment variables, user and group IDs, and current directory. The *minutes* argument is the number of minutes between repeated alerts.

### Disabling printer fault alerts

You can disable printer fault alerts if desired.

If you do not want the print service to issue an alert when a fault occurs, enter the following:

```
/usr/sbin/lpadmin -p printer-name -A none
```

If you want mail sent or a message written to another user when a printer fault occurs, use the **lpadmin** command with the **-A 'mail login-ID'** option or the **-A 'write login-ID'** option. If you do not specify a *login-ID*, the mail or message will be sent to your current login name. This may not be your login if you have used the **su** command to change your login.

### Disabling repeated printer fault alerts

After a fault occurs and you start receiving repeated alerts, you can direct the print service to stop sending you alerts (for the current fault only).

To direct the print service to stop sending you alerts (for the current fault only), run the following command:

```
/usr/sbin/lpadmin -p printer-name -A quiet
```

**Note:** Use the alert type of **quiet** only to terminate an active alert; do not specify **quiet** as the alert type for a new printer.

If the *printer-name* is **all** in any of the commands discussed, the alerting condition will apply to all printers.

If you do not define an alert method, you will receive mail once for each printer fault. If you define a method without the `-W` option, you will be alerted once for each fault.

## Printer fault recovery mechanisms

Printer fault recovery mechanisms allow the print service to recover when a printer fault has been fixed and the printer is ready for printing again.

**Note:** This information does not apply if you are making a remote printer accessible to users on your system.

When a printer fault has been fixed and the printer is ready for printing again, the print service will recover in the following ways:

- It will continue printing at the top of the page where printing stopped
- It will restart printing at the beginning of the print request that was active when the fault occurred
- It will wait for you to tell the print service to re-enable the printer

**Note:** The ability to continue printing at the top of the page where printing stopped requires the use of a filter that can wait for a printer fault to be cleared before resuming properly. Such a filter must have detailed knowledge of the control sequences used by the printer so it can keep track of page boundaries and know where in a file printing stopped. None of the filters supplied with the print service can do this. If an appropriate filter is not being used, you will be notified in an alert if recovery cannot proceed as you want.

### ***Specifying a printer fault recovery mechanism***

You can specify a printer fault recovery mechanism with the `lpadmin` command.

To specify the way the print service will recover after a fault has been cleared, enter one of the following commands:

- `/usr/sbin/lpadmin -p printer-name -F continue`
- `/usr/sbin/lpadmin -p printer-name -F beginning`
- `/usr/sbin/lpadmin -p printer-name -F wait`

These commands direct the print service to continue at the top of the page, restart from the beginning, or wait for you to enter an **enable** command to re-enable the printer.

If you do not specify how the print service is to resume after a printer fault, it will try to continue at the top of the page where printing stopped or, failing that, at the beginning of the print request.

If the recovery is **continue**, but the interface program does not stay running so that it can detect when the printer fault has been cleared, printing will be attempted every few minutes until it succeeds. You can force the print service to retry immediately by issuing an **enable** command.

## Mount forms and font cartridge alerts

You can set the print system to alert you when you need to mount a form or when the number of requests waiting for a font cartridge or form exceeds some threshold.

If you have printers that accept changeable font cartridges and you have listed the font cartridges allowed on each, users can submit a print request to use a particular font cartridge. However, if the font cartridge is not mounted when a user requests to use it, the job waits in the queue until you mount the font cartridge. See [“Specifying font cartridges to use with a printer” on page 249](#). If a form (or font cartridge) is not mounted when you print a file and specify that form, the job waits in the queue until you mount the appropriate form. See [“Mounting a form” on page 229](#).

### ***Setting up alerts to mount forms and font cartridges***

You can set up alerts to mount forms and font cartridges.

To arrange for alerting to the need to mount a form, enter:

```
lpforms -f form_name -A alert_method -Q number -W minutes
```

To arrange for alerting to the need to mount a font cartridge, enter:

```
lpadmin -S font_cartridge_name -A alert_method -Q number -W minutes
```

Setting up alters

---

| Item                | Descriptor                                                                  |
|---------------------|-----------------------------------------------------------------------------|
| <i>alert_method</i> | alerting method to use ( <b>mail</b> , <b>write</b> , or a desired command) |
| <i>number</i>       | number of waiting requests to restart alerting                              |
| <i>minutes</i>      | number of minutes between alerts                                            |

If you do not define an alert method for a form or font cartridge, you do not receive an alert for it. If you define a method, but do not define the number of minutes between alerts (with the **-W** option), you receive one alert for each occasion.

- To direct the print service to send electronic mail alerts every five minutes whenever the printer queue contains two or more requests for the **check** form and it is not already mounted, enter:

```
lpforms -f check -A mail -Q 2 -W 5
```

- To direct the print service to write alerts to your terminal every two minutes whenever the printer queue contains three or more requests for the **dingbat** font cartridge and the **dingbat** font cartridge is not already mounted, enter:

```
lpadmin -S dingbat -A write -Q 3 -W 2
```

- To arrange for alerting whenever the queue contains requests for any form or font cartridge, enter one of the following:

```
lpforms -f any -A mail -W 5
```

```
lpadmin -S any -A mail -W 5
```

- To stop receiving alert messages to mount a form or font cartridge, enter one of the following:

```
lpforms -f form_name -A quiet
```

```
lpadmin -S font_cartridge_name -A quiet
```

- To remove alerting when a form or font cartridge needs to be mounted, enter one of the following:

```
lpforms -f form_name -A none
```

```
lpadmin -S font_cartridge_name -A none
```

*Stopping alert messages to mount forms and font cartridges*

## Printer port characteristics

Printer port characteristics are attributes defined with the **-o "stty='stty-option-list'"** option of the **lpadmin** command.

Printers connected directly to computers and those connected over some networks require that the printer port characteristics be set by the interface program. These characteristics define the low level communications with the printer. Included are the baud rate; use of XON/XOFF flow control; 7, 8, or other bits per byte; type of parity; and output postprocessing. The standard interface program uses the **stty** command to initialize the printer port, minimally setting the baud rate and a few other default characteristics.

## Default printer port characteristics

The default characteristics applied by the standard interface program are listed in the following table.

| Default        | Description                                |
|----------------|--------------------------------------------|
| <b>9600</b>    | 9600 baud rate                             |
| <b>cs8</b>     | 8-bit bytes                                |
| <b>-cstopb</b> | 1 stop bit per byte                        |
| <b>-parenb</b> | No parity generation                       |
| <b>ixon</b>    | Enable XON/XOFF flow control               |
| <b>-ixany</b>  | Allow only XON to restart output           |
| <b>opost</b>   | Postprocess data stream as listed below:   |
| <b>-olcuc</b>  | Do not map lower case to upper case        |
| <b>onlcr</b>   | Map linefeed into carriage return/linefeed |
| <b>-ocrnl</b>  | Do not map carriage return into linefeed   |
| <b>-onocr</b>  | Output carriage returns even at column 0   |
| <b>nl0</b>     | No delay after linefeeds                   |
| <b>cr0</b>     | No delay after carriage returns            |
| <b>tab0</b>    | No delay after tabs                        |
| <b>bs0</b>     | No delay after backspaces                  |
| <b>vt0</b>     | No delay after vertical tabs               |
| <b>ff0</b>     | No delay after form feeds                  |

You may find that the default characteristics are sufficient for your printers. However, printers vary enough that you may have to set different characteristics. See the **stty** command for a complete list of characteristics.

If you have a printer that requires printer port characteristics other than those handled by the **stty** program, you will have to customize the interface program. See [“Printer interface scripts” on page 221](#) for help.

When you add a new printer, you may specify an additional list of port characteristics. The list you provide will be applied after the default list so that you do not need to include in your list items that you do not want to change. Specify the additional list as follows:

```
/usr/sbin/lpadmin -p printer-name -o "stty='stty-option-list'"
```

Note that both the double quotation and single quotation marks are needed if you give more than one item in the *stty-option-list*.

Suppose your printer is to be used for printing graphical data, where linefeed characters should be output alone, without an added carriage return. You would enter the following command:

```
/usr/sbin/lpadmin -p printer-name -o "stty=-onlcr"
```

Note that the single quotation marks are omitted because there is only one item in the list.

As another example, suppose your printer requires odd parity for data sent to it. You would enter the following command:

```
/usr/sbin/lpadmin -p printer-name -o "stty='parenb parodd cs7'"
```

## Setting up a printer with multiple names

The print service allows you to set up a single printer with multiple names to perform multiple functions.

For example, if your printer supports both portrait and landscape modes, you can set up a different name for each function and then send jobs to each printer name. These multiple printers are called *virtual printers*.

The print spooler system differentiates printers by name only, not by the device to which the printer is connected. To specify different names for the same device and prevent multiple print jobs from appearing simultaneously, you must set up both the *real* printer and additional *virtual* printers. The real printer performs the actual printing and the virtual printers pass print jobs to the real printer.

- To set up two virtual printers, **port** and **land**, that use the capabilities of a Hewlett-Packard LaserJet, use the following procedure:
  1. Set up the real printer. Specify the *Name* as **real** and set the *Model* to **HPLaserJet**.
  2. Set up the *port* and *land* virtual printers. Set the *Model* to **network**. Specify the same *Device* to which **real** is connected.
  3. Create the file `/usr/spool/lp/remote` and add the following lines:

```
port:    lp -dreal -oportrait
land:    lp -dreal -olandscape
```

This specifies that when printing to printer **land**, the print system sends the print job to printer **real** using the `-olandscape` option (to print in landscape mode) and when printing to printer **port**, the print system sends the print job to printer **real** using the `-oportrait` option (to print in portrait mode).

**Note:** The options listed after `-dreal` depend on the printer model. Check the interface script in `/usr/spool/lp/admins/lp/interface` for your printer to determine the printer- or class-dependent `-o` options.

- To print a file in landscape mode, enter:

```
lp -dland filename
```

This procedure translates the `-dland` option to **lp** to the necessary options for the printer (in this example, `-dreal -ol`).

Another way to accomplish this is to create a simple shell script to perform the type of printing. For example:

```
:
# Land - shell script to print in landscape mode
#
# syntax: land <file> <file> ...
#
#
lp -dreal -ol $@
```

The reasons for choosing one method over the other depend on how your applications access the print system. Many applications allow you to specify only the name of the printer, so virtual printers are the only solution. Other applications might allow complete control over the commands that submit the print job. In this case, you might use the shell script in the preceding example.

## Directory-enabled (LDAP) System V print on AIX

Lightweight Directory Access Protocol (LDAP) is a distributed hierarchical directory-service access protocol that is used to access repositories of user information and other network-related entities. The IBM Directory is an LDAP directory server.

The AIX System V print subsystem's use of IBM Directory allows for centralized storage of print information. This functionality can be used to keep printers, print queues, and system information

common in a client-server environment. The **mkprtlldap** command configures IBM Directory as a server containing System V print information, and one or more clients that use the IBM Directory (LDAP) for print information.

The System V print subsystem is directory-enabled, allowing the System V print subsystem to be managed using the information stored in the LDAP directory. The System V print subsystem is one of the many AIX subsystems that provide an option to store information in the directory. The information stored in the directory will be used by the subsystems to manage the AIX system. Other subsystems that use the LDAP directory include Security and Network Information Services (NIS).

Directory-enabled (LDAP) System V printing on AIX requires the following:

- AIX operating system.
- IBM Directory Server and Client v4.1 or later

**Note:** IBM Directory is provided with the AIX base operating system media.

## Planning to set up the print subsystem

Setting up the print subsystem to use IBM Directory (LDAP) involves two steps.

First, configure an IBM Directory (LDAP) server to store System V print information. This server will act as a centralized repository for System V print information. Second, configure the host systems (clients) to use the IBM Directory server for System V print information.

**Note:** The **mkprtlldap** command that is used to set up directory-enabled System V print on AIX can only be run by the root user. The **mkprtlldap** command only configures the IBM Directory server and client systems to use the IBM Directory for System V print information. To add, delete, and manage printers, print queues, and systems, run the directory-enabled System V print commands (**dslpaccept**, **dslpaccess**, **dslpadmin**, **dslpdisable**, **dslpenable**, **dslpreject**, and **dslpsearch**). The directory enabled System V print commands are provided with the `bos.svprint` file set, which must be installed on both the client and server. The client side configuration must be completed with the **mkprtlldap** command before running any of the directory-enabled System V print commands.

### Configuring the IBM Directory (LDAP) to store System V print information

You can configure the IBM Directory (LDAP) to store System V print information.

Installing and configuring the IBM Directory Server software on the AIX system that serves as the centralized repository for System V print information. If the system has the IBM Directory Server installed, go to step [“2” on page 255](#).

1. Install the IBM Directory Server software from the AIX base operating system media software. The IBM Db2 database is required by the IBM Directory Server. You must install the IBM Db2 database prior to installing the IBM Directory Server.

**Note:** For detailed instructions on installing and troubleshooting the IBM Directory, see the documentation that was provided with the IBM Directory product.

2. To configure the IBM Directory to store System V print information, run the **mkprtlldap** command with the server flag options.

```
mkprtlldap -s -a AdminDN -p Adminpasswd -w ACLBindPasswd [-f] [-d node DN]
```

The server flag options are described in detail in [“Server flag options” on page 258](#).

The **mkprtlldap** command works even if the directory server has been set up for other purposes, for example, for white pages information. In this case, the **mkprtlldap** command adds the AIX information tree and the print subtree information to the existing database. This print tree is protected independently from other trees by use of an Access Control List (ACL). In this case, the LDAP server works as usual. Back up your existing database before you use the **mkprtlldap** command to configure System V print information to share the same database.

### Configuration by using the **-s** flag

During the configuration, if you use the `-s` flag with the **mkprtlldap** command, the following occurs:

1. Checks the IBM Directory Server's DB2® configuration on the system. If DB2® is not configured for IBM Directory, the **mkprtlldap** command creates a Db2 instance with `ldapdb2` as the default instance name, and creates a Db2 database with `ldapdb2` as the default database name if one does not exist. If an existing database is found, the **mkprtlldap** command adds AIX System V print information to the existing database.
2. Requires the IBM Directory Administrator Distinguished Name (DN) and password if the directory has been previously configured. If the directory administrator DN and password have not been set, the **mkprtlldap** command sets them to the values provided to the command.
3. Adds the IBM Directory server process (**slapd**) to the `/etc/inittab` file so that the server starts after a reboot.
4. Creates the AIX information tree DN (`cn=aixdata` container object) on the directory if one is not present. The print subtree will be created under the AIX information subtree. If an existing AIX information subtree exists on the directory, the print subtree will be created under it. All System V print information will be stored under the print subtree. The directory-enabled System V print commands must be run to add printers and print queues under the print subtree created.
5. Adds the default suffix `cn=aixdata` to the `/home/ldapdb2/idsslapd-ldapdb2/etc/ibmslapd.conf` file if the suffix does not exist. Creates the AIX information tree container object `cn=aixdata` if it not found in the Directory. The `cn=aixdata` is a top-level container object under which the print subtree (`ou=print`) is then created.
6. The print subtree is ACL-protected with the value of the `ACLBindPasswd` parameter passed to the command. The same value must be used when configuring clients to use the directory for System V print information.
7. If the `-d` flag is used and a valid existing node on the directory is passed to the command, the AIX information subtree is created under the given node. The print subtree is then created under the AIX information subtree.
8. Starts the IBM Directory server after all the previous steps are completed.

#### Notes:

- If IBM Directory has been configured previously, the Administrator DN and password are needed to run the **mkprtlldap** command. The LDAP configuration is saved in the `/etc/slapd32.conf` file.
- If the IBM Directory (LDAP) server configuration is not successful, no undo option is provided for the server-side configuration. See the IBM Directory documentation for any errors that occur during the configuration. If the database information was created by the **mkprtlldap** command, you must remove it manually. If the **mkprtlldap** command has added data to a preexisting database, you must determine how to recover from a failed setup attempt. For details on how to remove data or databases, see the IBM Db2 documentation.

#### *System V print information subtree*

System V print information is stored under the print subtree, which in turn is stored under a default AIX Information tree (**cn=aixdata**) on the directory.

The AIX information tree is a top-level container object under which the different directory-enabled AIX subsystems can store their information. It is recommended to store the print information in the default location on the directory. However, the **mkprtlldap** command provides the option to store the print information under an existing node on the directory.

The following illustration shows the AIX System V print information stored in the directory in the form of a directory information tree (DIT).

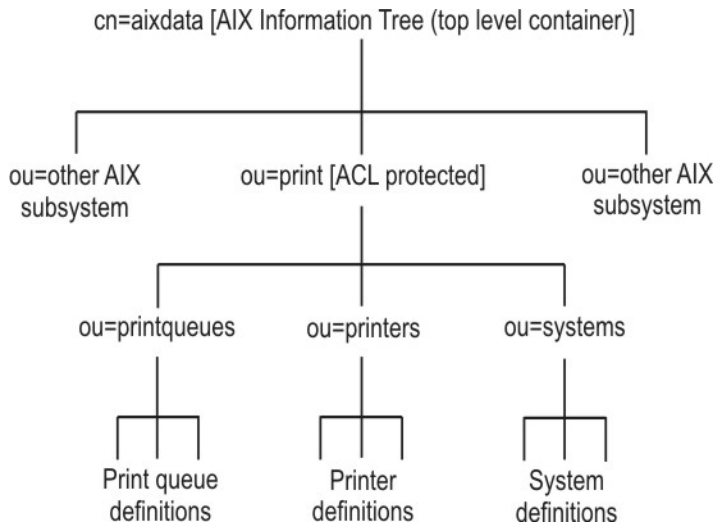

Figure 7. Organization of AIX System V Print Information

After you have successfully configured IBM Directory to store System V print information, the next step in the setup is to configure clients to use the LDAP directory server.

Because this AIX print subtree is ACL-protected, you may not be able to view the System V print information in the directory information tree (DIT) under the AIX information tree using DMT (Directory Management Tool). A client must bind with Print Bind DN (default is **ou=print,cn=aixdata**) and the ACL bind password or with the administrator DN to be able to access the AIX print subtree.

### Configuring a client to use the IBM Directory Server for System V print information

You can configure a client to use the IBM Directory Server (LDAP) for System V print information.

To configure a client, use the IBM Directory (LDAP) for System V Print information, do the following:

1. Install the IBM Directory Client software on the system that will be set up as a client.
2. Run the **mkprtldap** command with the client option to configure the client. The syntax is as follows:

```
mkprtldap -c -h DirectoryServerHostname -w ACLBindPasswd [ -d PrintBindDN ] [-U]
```

During the client configuration, the **mkprtldap** command does the following:

- Saves the IBM Directory (LDAP) server host name in the `/etc/ldapsvc/server.print` file.
- Saves the AIX Print Bind DN in the `/etc/ldapsvc/server.print` file.
- Saves the ACL Bind Password for the AIX Print Bind DN in the `/etc/ldapsvc/system.print` file. The value of the ACL Bind password must be the same as the one specified during the configuration of the Directory server.
- Undoes a previous client configuration if the `-U` flag is specified. This option replaces the `/etc/ldapsvc/system.print` and `/etc/ldapsvc/server.print` files with the previous saved copies of the `/etc/ldapsvc/server.print.save` and `/etc/ldapsvc/system.print.save` files.

The client-side configuration files `/etc/ldapsvc/server.print` and `/etc/ldapsvc/system.print` are created to store information about the IBM Directory server and ACL information; that is, the IBM Directory server name, ACL information (`printbindDN` and `printbindPassword`), LDAP port, and the directory context for print (required by the System V print subsystem). The default `printbindDN` is `ou=print,cn=aixdata` and is used when the `-d` flag is not specified. If a DN is specified with the `-d` flag, the print bind DN will be `ou=print,cn=aixdata, <DN specified>`. The following are sample `/etc/ldapsvc/server.print` and `/etc/ldapsvc/system.print` files:

Example of a `/etc/ldapsvc/server.print` file:

```
PRINTSERVER=server.ibm.com
LDAPPORT=389
PRINTBINDDN=ou=print,cn=aixdata
```

where:

*PRINTSERVER* is the host name of the system with the IBM Directory server, *LDAPPORT* is the port number to bind to, and *PRINTBINDDN* is the ACL Bind DN and also serves as the directory context for print

Example of a `/etc/ldapsvc/system.print` file:

```
PRINTBINDPASSWD=ldap
```

where:

*PRINTBINDPASSWD* is the ACL bind password for the print subtree.

The ACL bind password specified with the `-w` flag during client setup should match the ACL bind password value specified during server configuration. The print directory context is the same as the `printbindDN`. The file permissions for the `/etc/ldapsvc/server.print` file are set to 644 and the file is owned by root. The file permissions for the `/etc/ldapsvc/system.print` file are set to 640. The file is owned by root and members of the `lp` group are allowed read access to this file.

## Server flag options

These sections provide flag descriptions and examples for configuring directory-enabled System V print.

### Server-side options

| Flag | Parameter            | Description                                                                                                                                                                                                  |
|------|----------------------|--------------------------------------------------------------------------------------------------------------------------------------------------------------------------------------------------------------|
| -a   | <i>AdminDN</i>       | Specifies the IBM Directory (LDAP) administrator DN.                                                                                                                                                         |
| -d   | <i>node DN</i>       | [Advanced Option] - This option requires a valid existing node DN on the directory under which the AIX information tree and print subtree will be created.                                                   |
| -f   |                      | The force flag is required by the <b>mkprtldap</b> command to force the creation of the print subtree (and AIX information subtree if needed) when one or more AIX information trees exist on the directory. |
| -p   | <i>adminpasswd</i>   | Specifies the directory (LDAP) administrator's password                                                                                                                                                      |
| -s   |                      | Indicates the command is being run to configure the directory for System V print.                                                                                                                            |
| -w   | <i>ACLBindPasswd</i> | Specifies the password to ACL-protect the print subtree on the directory.                                                                                                                                    |

### Client-side options

| Flag | Parameter                      | Description                                                                                                                                                                                                                    |
|------|--------------------------------|--------------------------------------------------------------------------------------------------------------------------------------------------------------------------------------------------------------------------------|
| -c   |                                | Indicates the command is being run to configure clients to use the directory for System V print information.                                                                                                                   |
| -d   | <i>PrintBindDN</i>             | Specifies the print bind DN. The default print bind DN is <code>ou=print,cn=aixdata</code> . The print bind DN to use during client configuration is displayed at the end of the server setup of the <b>mkprtldap</b> command. |
| -h   | <i>DirectoryServerHostname</i> | Hostname of the IBM Directory server set up to store System V print information.                                                                                                                                               |
| -U   |                                | Undo a previous configuration of a client                                                                                                                                                                                      |

## Usage

| Flag | Parameter | Description                                                  |
|------|-----------|--------------------------------------------------------------|
| ?    |           | Displays usage information for the <b>mkprtldap</b> command. |

## System V print examples

Examples for common scenarios are provided.

1. To configure a new installation of IBM Directory for System V print with the administrator DN **cn=root** and root password, enter:

```
mkprtldap -s -a cn=root -p root -w aclBindpassword
```

where *aclBindpassword* is the password used so that the ACL protects the print subtree. The ACL bind password is specified during the configuration of System V print on the directory. This configuration also sets the directory administrator's DN and password to **cn=root** and root. Running the command sets up a suffix and top-level container object **cn=aixdata**. The print subtree (**ou=print**) is created under this AIX information tree (**cn=aixdata** object).

2. To configure System V print on a machine with a configured IBM Directory server, the administrator DN and password are required. For example, if the existing administrator's DN and password are **cn=admin** and **passwd**, enter:

```
mkprtldap -s -a cn=admin -p passwd -w pass123wd
```

3. To configure System V print under a preexisting node on the IBM Directory server (for example, **o=ibm,c=us**), the **mkprtldap** command provided the **-d** flag option. This is an advanced option recommended only when it is necessary to store the print information under an existing node on the directory. The recommended option is to store the print subtree in the default location on the directory by not specifying the **-d** option.

The administrator DN and password are required to configure System V print on the directory. Assume the existing administrator's DN and password are **cn=admin** and **passwd**. Enter:

```
mkprtldap -a cn=admin -p passwd -w acl123passwd -d o=ibm,c=us
```

Running the command creates an AIX information tree (**cn=aixdata**) under the **o=ibm,c=us** object. The print subtree is created under this new object (**cn=aixdata, o=ibm, c=us**).

4. To configure System V print information under a separate AIX information tree when the directory contains an existing AIX information tree for other subsystem-specific information. There could be situations in which the directory may contain an existing AIX information tree with Security or NIS information. It may be necessary to store the print information in a separate location on the directory under a different AIX information tree. By default, the **mkprtldap** command does not create an AIX information tree if one exists on the directory. To force the **mkprtldap** command to create an AIX information tree to store the print information, use the **-f** flag.

Consider an example where the security and NIS subsystem information is stored under the AIX information tree at **cn=aixdata,o=ibm,c=us**. To create a new AIX information tree for print information different from the existing one, run the command with the **-f** flag and specify the default location or another node.

The Administrator DN and password are required to configure System V print on the directory. For example, if the existing administrator's DN and password are **cn=admin** and **passwd**, enter:

```
mkprtldap -a cn=admin -p passwd -w passwd123 -f
```

Running the command creates an AIX information tree (**cn=aixdata**) with the suffix (**cn=aixdata**) and the print information is stored under this new AIX information tree (**ou=print, cn=aixdata**). There will be two AIX information trees on the directory in this example: **cn=aixdata,o=ibm,c=us** and **cn=aixdata**. The print information will be under the **cn=aixdata** object (suffix - **cn=aixdata**). For the

**mkprtlldap** command, it is recommended to use the default location to add the print information to the directory.

5. To configure a client to use IBM Directory setup for System V Print on host **server.ibm.com**, enter:

```
mkprtlldap -c -h server.ibm.com -w passwd
```

Ensure that the ACL bind password (passwd) is the same as the one specified during the setup of the Directory server. Running the command without specifying a print bind DN value with the **-d** option will cause the command to use the default print bind DN **ou=print,cn=aixdata**. The Print Bind DN must match the one displayed as a result end of running the **mkprtlldap** command when you configure the server.

6. To change the information in the client-side configuration files, run the **mkprtlldap** command with the new information. Enter:

```
mkprtlldap -c -h server.ibm.co.uk -w aclpasswd -d ou=print,cn=aixdata,c=uk
```

Running this command on a client that has already been configured will change the information in the `/etc/ldapsvc/server.print` and `/etc/ldapsvc/system.print` files to contain the new configuration information. The original contents of the `/etc/ldapsvc/server.print` and `/etc/ldapsvc/system.print` files will be stored in the `/etc/ldapsvc/server.print.save` and `/etc/ldapsvc/system.print.save` files.

### **Files accessed during server and client configuration**

The **mkprtlldap** command accesses and modifies several files during server and client configuration.

The following table shows files that are accessed and modified by the **mkprtlldap** command during server and client configuration and descriptions. It also shows the contents of the files.

| <b>Mode</b> | <b>File</b>                      | <b>Description</b>                                                                                                                                                                             |
|-------------|----------------------------------|------------------------------------------------------------------------------------------------------------------------------------------------------------------------------------------------|
| <b>rw</b>   | <b>/etc/slapd32.conf</b>         | Server setup - Contains the IBM Directory (LDAP) configuration information                                                                                                                     |
| <b>rw</b>   | <b>/etc/ldapsvc/server.print</b> | Client configuration - Contains information about the directory server configured to store System V Print information (machine name, location of print subtree on the directory and LDAP port) |
| <b>rw</b>   | <b>/etc/ldapsvc/system.print</b> | Client configuration - Contains the ACL bind password for the print subtree on the Directory                                                                                                   |

## **Base operating system spooler troubleshooting**

Troubleshooting the base operating system spooler can be done by tracking a spooler job through the spooler. A job submitted to the base operating system spooler moves from one spooler component to another in a predictable fashion. The movement is entirely dependent upon the spooler queue configuration, especially the spooler queue backend.

**Note:** To perform serious spooler troubleshooting, root authority is required. Users running without root authority are limited to:

- Submitting jobs to the spooler
- Sending data directly to the device driver entry point in the `/dev` directory
- Querying the status of spooler queues
- Changing the status (including cancelling) of spooler jobs owned by the user

**Note:** This troubleshooting information assumes that you have access to a shell prompt. There are a number of front-ends to the base operating system spooler itself on the market; troubleshooting in this environment is still very possible, but if the problem lies in the command or method used to

actually submit a job to the spooler, the application must provide a method for precisely determining the command or method used to submit the job to the spooler.

## Troubleshooting a local printer

Check the following items if you are having problems with your local printer:

- Verify that the **qdaemon** is running. Make sure there are no forked processes running from the **qdaemon**.
- Make sure the system date is correct. The **qdaemon** automatically rebuilds the `qconfig.bin` file when the `qconfig` file changes. If the date on the `qconfig` file is earlier than the date on the `qconfig.bin` file, the `qconfig` file is not digested, even if it was just modified.
- If the dates on the `qconfig.bin` file and the `qconfig` file are correct, and changes to the `qconfig` file are correct, the `/etc/qconfig` file is no longer linked to the `/usr/lpd/qconfig` file.
- Check that the `/tmp` directory is not full. The `/tmp` directory may be full if you receive a message such as **No Virtual Printers Defined**.
- If no other user except root can print, check the permissions of the `/tmp` directory. Also, check the permissions of the print commands being used (including **enq**).
- Check for obsolete queue names in the `/var/spool/lpd/qdir` file. A problem with the installation of a new `/etc/qconfig` file occurs when a queue is removed from the new `/etc/qconfig` file and a print request is made using the obsolete queue name. The **qdaemon** logs an error message. You must determine if the message refers to an old queue. If so, the problem will exist until you remove the obsolete queue entries from the `/var/spool/lpd/qdir` file.
- If operator-attention messages requested by print commands are not being received, make sure the socket is connected and the host name can be pinged with the **ping** command.
- Operator-attention messages from print commands are routed through the **writesrv** command of the TCP/IP subsystem. If messages are not being received, check to see if the **writesrv** command is running by entering the command:

```
lssrc -s writesrv
```

If the **writesrv** command is not running, start it with the following command:

```
startsrc -s writesrv
```

Finally, make sure that **writesrv** is listed in the output of one of the following commands:

```
netstat -a | pg
```

OR

```
netstat -a | grep writesrv
```

**Note:** The AIX operating system does not support printers that are attached to your system through a Universal Serial Bus (USB).

## Troubleshooting an inoperative printer

Use these troubleshooting steps for locally attached printers that have never worked.

If you have inoperative printers, check the following items:

- Run the test pattern for the printer with only the power cable attached to the printer.
- Verify that you have the correct cable for the printer.
- Make sure the cable is securely plugged in.
- Verify that you have created a device for the printer (with Devices, SMIT, or at the command line).
- Try the following command immediately after a reboot or when you have not tried to send anything to the printer since a reboot.

```
echo Does the printer work? > /dev/lpn
```

where *lpn* is the name of the printer device you are testing. If the message prints at the printer, set up the virtual printer definition for the printer. If the statement hangs or returns an error message, the problem is not the operating system or the queuing system. It is one or more of the following:

- The cable.
- The setup, such as baud rate, handshaking, and port number. The printer and the computer must have the same settings.
- A bad port on the computer.
- A broken printer.
- If you have trouble getting a serial printer to work on an 8-port, 16-port, or 64-port adapter or on a modem, try to get the printer working on S1 or S2 directly on the computer. After the printer works on S1 or S2, move the printer to the desired port. If S1 and S2 are unavailable, try moving the printer to any other port.

## Troubleshooting a remote printer

You can use this information to troubleshoot a remote printer.

Check the following items for the host acting as the remote print server:

- Make sure that all client machines (foreign hosts) are listed in the `/etc/hosts.lpd` file.
- Make sure that the TCP/IP subsystem is running.
- Check for the existence of the `/usr/spool/lpd` directory.
- Make sure that the `/etc/locks/lpd` directory does not exist if the **lpd** daemon is not running.
- Make sure that both the **lpd** daemon and the **qdaemon** are running.
- Check “[Troubleshooting a local printer](#)” on page 261.

Check the following items for hosts printing to a remote print server:

- Verify that the queue name and server name for the remote print server are correct in the `/etc/qconfig` file.
- Make sure that the TCP/IP subsystem is running.
- Make sure that the **qdaemon** daemon is running.

## Adapter considerations

The 16-port RS-232 adapter does not support clear to send (CTS), so a printer connected to this adapter will not finish printing a job if the printer is powered off while the job is printing.

The 16-port RS-232 adapter does not support clear to send (CTS). A printer connected to this adapter will not finish printing a job if the printer is powered off while the job is printing. You must restart the job or delete it manually.

## Resource considerations

Printing generates processes. Printing a job might take up anywhere from one to five processes in most instances.

As with any other activity, it is possible to exhaust the number of processes on the system. This can happen by submitting a single print job on a very actively used system, or by submitting large numbers of jobs on a system with little other activity.

Running out of processes can cause erratic behavior on your system. If you experience erratic behavior on your system, check your resources to determine if you are running out of processes.

## Correcting printing problems when the var file system is full

Printing problems occur when the `/var` file system is full.

Printing problems occur when the `/var` file system is full. This usually happens when print jobs sent to the print queue begin to back up for some reason, causing the spooling directory within the file system to grow too large. The spooling directories usually affected are `/var/spool/lpd` and `/var/spool/qdaemon`.

The print queue can back up if the queue daemon has stopped functioning, the printer has gone down or has been turned off, or a large print job sent to the printer has occupied all resources. The `/var` file system can also fill up if other directories in the file system besides the spooling directory grow too large.

When the `/var` file system is full, perform one of the following tasks:

### Reactivating the queue daemon

The queue daemon (or **qdaemon**) process tracks print job requests and the printers available to handle these requests.

The **qdaemon** maintains queues of outstanding requests and, as devices become available, sends them to the proper device at the proper time. If the **qdaemon** stops functioning, you will experience printing problems and will then need to restart the **qdaemon** using the following procedure.

**Note:** Some commands may require root user or system group authority.

1. Determine if the **qdaemon** has stopped functioning by entering the following **ps** command:

```
ps -ef | grep qdaemon
```

If you do not see a process called `/var/sbin/qdaemon`, **qdaemon**, or `/etc/qdaemon` running, the **qdaemon** is not running.

2. Restart the **qdaemon** by entering the following **startsrc** command:

```
startsrc -s qdaemon
```

If you are not using the system resource controller (SRC), you can also restart the queue daemon with the **qdaemon** command.

3. Let the **qdaemon** print all the jobs in the print queue.
4. Make sure the **lpd** daemon is up and running by entering:

```
startsrc -s lpd
```

The **lpd** daemon provides the remote print server on a network.

### Clearing a print queue backlog

If you need to clear a print queue backlog, you must stop **qdaemon** and check if the `/var` file system is full.

You must be logged in as root.

If the `/var` file system is full, use the following procedure to clear the queue directories and restart the **qdaemon**.

1. If possible, let all current print jobs finish printing or cancel them. To cancel a print job, issue the **lpstat** command to get the print job number, then use the **enq** command to cancel the print job.

```
enq -x JobNumber
```

The **lpstat** command displays information about the current status of the line printer. The **enq** command enqueues a file.

2. Issue the following command to stop **qdaemon**:

```
stopsrc -s qdaemon
```

- Issue the following commands to verify that **qdaemon** did not fork other processes:

```
ps -ef | grep qdaemon
```

```
ps -ef | grep pio
```

The **ps** command shows the current status of processes. The **grep** command searches a file for a pattern.

If you get one line back from each of the above **grep** commands, skip step 4 and go to step 5. If you get more than one line, go to step 5.

- If other **qdaemons** or **pios** were returned by the **ps -ef** command, kill these processes by issuing the following command with each process ID:

```
kill -9 pid
```

The following example shows a **qdaemon** returned by **ps -ef**. The process ID is 3357.

```
root 3357 2288 0 13:32:21 - 0:04 dtterm
```

To kill this process ID, enter **kill -9 3357** at the command line.

- Perform this step only if it is necessary to save the current print jobs from being deleted. Otherwise, proceed to step 7.

If your print job is queued in one of the following directories, make a copy of it, and place it in **/tmp**. You can print it when the queuing system is running again.

```
/var/spool/qdaemon  
/var/spool/lpd
```

**Note:** In these directories, the files will have unfamiliar system names.

- If the **/var** file system gets too full, you may experience problems with **qdaemon** or the spooler. Large print jobs may fail, or **00root** files with zero lengths may appear in your **qdir** directory. Rebooting the system in this case may not clear out the files or restart **qdaemon**.

Enter the **df** command and look in the **%used** column for **/var** to see if the file system is too full. Free space in the file system as necessary.

The **df** command displays information about total space and available space on a file system.

- Change the directory as follows:

```
cd /var/spool/lpd/qdir
```

- Issue a **pwd** command to verify that you are in the proper directory. Then, remove all files in this directory using the **rm** command:

```
rm *
```

The **pwd** command writes to standard output the full path name of your current directory (from the root directory). The **rm** command removes the entries for the specified file or files from a directory.

- Change the directory again:

```
cd /var/spool/lpd/stat
```

- Issue a **pwd** command to verify that you are in the proper directory. Then, remove all files in this directory:

```
rm *
```

- Change the directory again:

```
cd /var/spool/qdaemon
```

12. Issue a **pwd** command to verify that you are in the proper directory. Then, remove all files in this directory:

```
rm *
```

13. Follow this step if you are having trouble with the remote queue or **lpd**. Change the directory:

```
cd /var/spool/lpd
```

Issue a **pwd** to verify that you are in the proper directory. Then, remove all files in this directory using the **rm** command:

```
rm *
```

**Note:** The **rm** command will not remove the subdirectories.

14. Start **qdaemon**:

```
startsrc -s qdaemon
```

The queuing system should start normally. If some queues are still down, bring them up by entering:

```
enable QueueName
```

## Reallocating printer resources

You can use these procedures to avoid having one print job use all of the printer resources.

**Note:** Some commands may require root user or system group authority.

1. Determine if a print job is using all resources in one of two ways:

- Use the following **lpq** command:

```
lpq
```

The **lpq** command, when entered without flags, reports the status of the default queue.

- Use the following **enq** command:

```
enq -q
```

The **enq** command enqueues a file to a shared resource, typically a printer (that is, it puts files into a queue for a particular resource). The **-q** flag displays the status of the default queue.

2. Use one of the following commands to remove the job from the print queue (you must have root user authority to cancel jobs other than your own):

- Use the following **enq** command:

```
enq -x 21
```

In this example, the **enq** command uses the **-x** flag to cancel job number **21**.

- Use the following **lprm** command:

```
lprm -P lp0 42
```

In this example, the **lprm** command removes job number **42** from the **lp0** printer queue, named with the **-P** flag. You can also remove jobs for a specific user by naming the user on the command line.

- Use the following **qadm** command:

```
qadm -X lp0
```

In this example, the **qadm** command uses the `-x` flag to cancel all jobs on the **lp0** printer.

- Use the following SMIT fast path for the **qcan** command:

```
smit qcan
```

In this example, you can choose the **By Print Queue** option to cancel either all of a particular user's jobs or all jobs on a particular printer.

3. Tell the sender of the print job to first divide it into smaller pieces by using the following **split** command, and then send the file as a series of jobs:

```
split -50 bigfile
```

The **split** command reads the specified file and writes it into segments to a set of output files. In the previous example, **bigfile** is split into 50-line segments named **bigfileaa**, **bigfileab**, **bigfileac**, and so forth.

## Deleting unnecessary directory files

You can delete unnecessary files in the spooling directory.

Some of these commands require root user or system group authority.

1. Determine if there are unnecessary files stored in the spooling directory by entering the following **du** command:

```
du -rs /var/spool
```

The **du** command summarizes disk usage. The `-s` flag instructs the **du** command to display only the total disk usage of the `/var/spool` directory and the files it contains. The `-r` flag tells the **du** command to display an error message if it cannot read a file or directory.

2. Delete or move files in a full directory by doing one of the following:

- Delete any extraneous files. For example:

```
rm extrafile
```

- Move files that are a few hours old to a safe temporary directory. For example:

```
mv extrafile /u/spoolhold
```

**Note:** You must have root user authority to remove or move files other than your own.

3. Prevent users from storing files in your spooling directories by doing the following:

- Set permissions on the spooling directory using the **chmod** command. Change the directory to exclude general users. For example:

```
chmod go-rw /var/spool/lp0
```

- Create a **cron** job to clean out the directory (you must have root user authority). Edit the **crontab** file. For example, you might add the following line to your **crontab** file:

```
find /spool -mtime +7 -a -exec rm -f
```

This line removes any file in the **/var/spool** directory one week after the last modification.

- Establish policy for the whole user group.

Create a script to identify all users whose disk holdings are above a certain threshold and send them e-mail requesting that they clean up their files.

- Provide an alternate way to store files, such as a tape drive in a public area, so that users can archive infrequently used files.

4. As a last resort, mount more space to the spool directory by using one of the following methods:

- Use the **mount** command, which makes a file system available for use at a specified location. For example:

```
mount /var/spool morespool
```

- Use the **smit mount** command, choose the **Mount a File System** option, and specify the file system name and attributes.

## Troubleshooting the terminal-attached printer

Check the following items when the printer attached to an ASCII terminal does not produce output:

- Verify that the **AUX** port on the terminal is configured with the same settings as your printer. To do this, consult your terminal documentation for information about setting values for the AUX port. Consult your printer documentation for information about configuring the printer's serial interface. Relevant values include those for baud rate, parity, data bits, stop bits, and XON/XOFF.
- If your terminal is emulating a terminal of a different type, you may need to set the **PIOTERM** environment variable.

```
export PIOTERM=TerminalTypeEmulated
```

- Verify that you have the correct cable for the printer.
- Make sure the cable is securely plugged into the terminal's auxiliary port.
- Make sure the print queue is READY:

```
lpstat
```

If the status for the terminal-attached printer queue does not read READY, enter the following commands to cancel all jobs on the queue and restart it:

```
qadm -Xqname
```

```
qadm -Uqname
```

where *qname* is the name of the terminal-attached printer queue. You must resubmit your print jobs.

- Verify that the **pioout** command has the correct permissions:

```
/usr/lib/lpd/pio/etc/pioout -r-sr-xr-x
```

To reset permissions, enter the following command:

```
chmod 4555 /usr/lib/lpd/pio/etc/pioout
```

- Check [“Troubleshooting a local printer”](#) on page 261.
- Sometimes printer control codes conflict with the terminal's control codes. If the previous checklist items do not produce output, reconfigure your virtual printer as an ASCII Printer. See [“Configuring a virtual printer and print queue”](#) on page 23.

If echoes of keyboard input are mixed with printer output, check the following:

- Adjust the virtual printer attributes specific to terminal-attached printers. To do this, use the SMIT fast path command:

```
smit chvirprt
```

- Resubmit the print request and avoid typing while the request is printing.
- If the ASCII terminal locks, turn the terminal off and on.

## Considerations for an 8-bit printer attached to a 7-bit interface

There are several considerations when using 8-bit printers with a 7-bit interface.

Some printers assume an 8-bit (8 bits per byte) interface to the host. Although an 8-bit printer may print when attached to a 7-bit interface, the printed output may not be acceptable. To determine if your printer assumes an 8-bit interface, consult your printer manual.

Incorrect printed output can be produced in the following situations:

- Printer command sequences may contain 8-bit values.

If an 8-bit printer must be attached to a 7-bit interface, follow this procedure to prevent incorrect printed output.

1. Enter the SMIT fast path **smit lsvirprt**.
2. Select the print queue and enter:

```
j=!j=!
```

3. Press the Enter key to exit.

This prevents print file initialization strings, which may contain 8-bit command sequences, from being sent to the printer.

**Note:** This also bypasses printer initialization. So, depending on the pitch, line spacing, and other attributes left by the previous print file, the output may not print correctly.

- Printer character code points may be 8-bit values where each graphical character is represented by an 8-bit integer value, causing the wrong character to be printed. To avoid this problem, all of the characters in the print files should be in the portable ASCII character set.
- Printed graphic files are affected when a 7-bit interface is used because some of the data points are lost.

## Troubleshooting the queue daemon

Use these troubleshooting steps if there is a problem with the **qdaemon** command.

Under normal circumstances, the **qdaemon** command starts when the system starts, runs until the system shuts down, and requires no attention from you (see the **qdaemon** command for more information). Sometimes, however, the **qdaemon** command may stop running or be unable to perform its function. The following information explains what you need to do under these conditions.

Any of the following conditions indicates that the **qdaemon** command needs maintenance:

- The **enq** command requests return the following message:

```
cannot awaken qdaemon (request accepted anyway)
```

- The **qdaemon** command detects serious inconsistencies within itself and displays an error message.
- The **ps -ef** command (the process status command that gives a full listing of all processes) does not show a process named **/usr/sbin/qdaemon** or **qdaemon**.

To start the **qdaemon** command, issue the following command:

```
startsrc -s qdaemon
```

Generally, only users with root privilege can use this command. The new **qdaemon** command goes through an initialization process.

If the **qdaemon** command does not continue running, make sure that both the **qdaemon** command and the **enq** command have the appropriate permissions. The person with root authority owns both the **qdaemon** command and the **enq** command. The **qdaemon** command and the **enq** command must run as

if they are run by the user who owns them. The permission bit **s** sets the effective owner (user ID) of a process to that of the nominal owner. The appropriate permissions for these two commands are:

| Item                     | Descriptor                                                                                                                                                                                                        |
|--------------------------|-------------------------------------------------------------------------------------------------------------------------------------------------------------------------------------------------------------------|
| <b>qdaemon</b> -r-sr-s-- | To check these permissions, enter <code>aclget /usr/sbin/qdaemon</code> .<br>To reset permissions, enter: <code>tcbck -y /usr/sbin/qdaemon</code> . You must have root user authority to reset these permissions. |
| <b>enq</b> -r-sr-sr-x    | To check these permissions, enter <code>aclget /usr/bin/enq</code> .<br>To reset permissions, enter: <code>tcbck -y /usr/bin/enq</code> . You must have root user authority to reset these permissions.           |

If you continue to have problems with the **qdaemon** command, you can use the following procedure to reinitialize the entire queuing system:

1. If the **qdaemon** command is running (use the **ps** -ef command to find out), end it by entering `stopsrc -s qdaemon`.
2. If any backends are running, use the **kill** command to stop them. See the **kill** command for more information.
3. Delete the contents of the following directories:
  - /var/spool/lpd/stat
  - /var/spool/lpd/qdir

**Note:** All jobs currently queued for printing are canceled and must be resubmitted.
4. Restart the **qdaemon** command by entering `startsrc -s qdaemon`. See the **startsrc** command for more information.

## Queuing system problems

The queuing system shows one or more queues in the **DEV\_WAIT** status when you have verified that the queue is not waiting on the printer. The queue may not wait because the printer is offline, is out of paper, is jammed, or the cable is loose, bad, or wired incorrectly, and the queue is not changed to **DOWN** status within the TIMEOUT period. In this scenario, use the following method to clear and restart the queuing system.

This method stops the **qdaemon**, removes all the queued jobs, and restarts the **qdaemon**. You must have root authority.

To stop the **qdaemon** daemon, use the following command:

```
stopsrc -s qdaemon
ps -e | fgrep qd
kill -9 PIDNumbers
```

where *PIDNumbers* are any PIDs resulting from running the **ps** command.

```
ps -e | fgrep pio
kill -9 PIDNumbers
rm /var/spool/lpd/stat/_dev_DEVICE
```

where *DEVICE* is the device that is showing the DEV\_WAIT status.

```
rm /var/spool/lpd/stat/s.QUEUE.DEVICE
```

where *QUEUE* is the queue and *DEVICE* is the device that is showing the DEV\_WAIT status.

```
mkdir /tmp/QDIR
mv /var/spool/lpd/qdir/NNUSER:QUEUE /tmp/QDIR
```

where *NN* is a number, *USER* is the user who queued the job and *QUEUE* is the queue that is showing the DEV\_WAIT status.

To start the **qdaemon** daemon, use the following command:

```
startsrc -s qdaemon
```

After the queueing system is cleared and functions properly, you need to stop the **qdaemon**, copy the jdf files from the /tmp/QDIR path to /var/spool/lpd/qdir path, and then restart the **qdaemon**.

## qdaemon testing

If submitting jobs to the spooler causes no discernible spooler activity, use the following information to determine and resolve the problem.

Assume a local ASCII print queue named **asc**.

Is the **qdaemon** running?

Issue the command `enq -Pasc /etc/motd`. If the **qdaemon** is not active, a variant of the following message will be displayed:

```
enq: (WARNING): Cannot awaken qdaemon. (request accepted anyway)
```

```
enq: errno = 2: No such file or directory
```

```
enq: (WARNING): Cannot awaken qdaemon. (request accepted anyway)
```

```
enq: errno = 2: No such file or directory
```

Issue the command `ps -ef | grep qdaemon` to verify that the **qdaemon** is not active. If the **qdaemon** is not active, you should see, at the most, a line of output representing the **grep** itself. It should look something like this:

```
root 2992 18792 0 12:46:39 pts/2 0:00 grep qdaemon
```

If the **qdaemon** is active, which it almost certainly will not be, you will see a variant of the following line:

```
root 2980 3652 0 12:41:25 - 0:00 /usr/sbin/qdaemon
```

If the **qdaemon** is not active, issue the command `startsrc -s qdaemon` to restart the **qdaemon**. If the **qdaemon** died, it should have been restarted automatically by the **srcmstr** process, but this does not always work, so restart it manually. You should see a variant of this message:

```
0513-059 The qdaemon Subsystem has been started. Subsystem PID is 3000.
```

Wait a minute or so and reissue the command `ps -ef | grep qdaemon`. Is the **qdaemon** still active or did it start and then quit?

The **qdaemon** may no longer be active, despite the fact that you just restarted it and received a message stating the process ID (PID) of **qdaemon**. Check for the existence of the file named `/var/spool/lpd/stat/pid`. You can do this by issuing the command `cat /var/spool/lpd/stat/pid`. This file contains the PID of an active **qdaemon**. When the **qdaemon** is not active, the file is *supposed* to be removed.

If the **cat** command prints a number on your display, that *should* be the PID of an active **qdaemon**. If you have already determined that the **qdaemon** is not active, remove the file `/var/spool/lpd/stat/pid` because a previous instance of the **qdaemon** somehow quit without causing this file to be removed. If the file does not exist, you should see a message like:

```
cat: cannot open /var/spool/lpd/stat/pid
```

The **qdaemon** was inactive, you restarted it, it quit again, the file `/var/spool/lpd/stat/pid` existed, and you removed that file. Restart the **qdaemon** again using the command `startsrc -s qdaemon`. Wait a minute or so and issue the command `ps -ef | grep qdaemon` again to see if the **qdaemon** remained active. You can also issue the command `cat /var/spool/lpd/stat/pid` again to see if the file was recreated and now contains a valid PID.

If the answer to the original question, *Is the qdaemon running?*, was *yes, it is*, then it is possible that the **qdaemon** is waiting on all currently running jobs to complete before it shows any signs of accepting new jobs. This scenario often occurs when a machine running the base operating system has a large number of printers (more than 25) attached to asynchronous adapters, such as 64-port or 128-port adapters.

To check to see if the **qdaemon** is waiting on a job to complete before it runs any more jobs, use the **lpstat** command to see if any jobs have a status of **RUNNING**. If so, physically examine the printers that show **RUNNING** jobs and verify that at least one job is actually running. If one or more printers are showing **DEV\_WAIT** because of paper jams or because they are out of paper, fix the problem and see if the printers begin printing. If they do not begin printing, again use the **lpstat** command to see if the queue status is **RUNNING**. In any of these circumstances, the purpose of checking the printers is to verify that at least one printer is actually printing even though the **qdaemon** is not starting new jobs.

Now submit a new job to the spooler with the command `enq -Pasc /etc/motd`.

Use the **lpstat** command to examine the queue status. If the new job has a job number of **NEW**, then the **qdaemon** is, for some reason, focused on running other jobs and will not start any new jobs until the current jobs are complete. You can only wait. You cannot even cancel the jobs that are running, since job cancellation requests are jobs as well, and the **qdaemon** is not taking new jobs.

## Spooler queue testing

When spooling jobs from an application, it is often not clear if a job is actually getting to the spooler.

Assume you are having problems with a queue named **asc**.

Issue the command `disable asc` to disable the spooler queue. Issue the command `lpstat -pasc` to verify that the queue is **DOWN**. Now submit a job to the queue using the application.

Use **lpstat** to verify that the job is on the **asc** queue (as long as the queue status is in a temporary **DOWN** state, the **qdaemon** will put a job on the queue but will not allow it to be processed.) If the job is not on the queue, use personal knowledge, application documentation, or application technical support to determine what might be wrong. If possible, determine exactly what job submission command or method is being used by the application and try it from the command line. It is possible that the application is hiding error messages being returned by either **enq** or the **qdaemon**.

## Spooled print job copies

It can be useful to make a copy of a spooled print job, particularly in a remote spooling environment.

When a job is submitted to the spooler, a job description file (JDF) is created and stored in `/var/spool/lpd/qdir`. If the queue is a remote queue, with something like **rembak** as the backend, the job will be transferred to the print server, where **enq** will make another JDF and put the job onto the specified print server queue.

If jobs seem to be vanishing at the print server, disable the print server queue (`disable asc`, for the ASCII queue example), and resubmit the job. Because the **asc** is down, the **lpstat** command should show the job as queued, but the queue will be **DOWN** and so the job will not be processed. Look in `/var/spool/lpd/qdir` for the JDF for this job. The last line of the JDF is the full path name to the spooled copy of the input data stream. Copy that file to some temporary file, such as `/tmp/myfile`. When you copy the file, you lose all of the flags that were associated with the job; all you are copying is the input data stream itself.

Enable the **asc** queue (`enable asc`) and allow the job to be processed. If it vanishes, submit the copy you made `enq -Pasc /tmp/myfile`. If this job also vanishes, then you need to examine the input

datastream for errors, as the printer for some reason does not print it. If the copy prints, then you probably have a problem with flags associated with the original job.

## Cleaning up and starting over

You can clear and restart the print spooler.

This procedure completely clears and restarts the spooler system. All jobs currently queued for processing are deleted and must be resubmitted. Use it when you cannot troubleshoot an inoperative spooler. You must be the root user to perform this task.

1. Stop the **qdaemon**:

```
stopsrc -s qdaemon
```

2. Stop associated processes:

```
ps -ef | grep qd  
kill -9 PIDNumbers
```

where *PIDNumbers* are PIDs resulting from the **ps** command. You may find **qdfork**.

3. Stop associated processes:

```
ps -ef | grep pio  
kill -9 PIDNumbers
```

where *PIDNumbers* are PIDs resulting from the **ps** command. You may find **pioformat** or **pioout**.

4. Clean out the queue and device status directory.

```
rm /var/spool/lpd/stat/*_dev_*  
rm /var/spool/lpd/stat/s*
```

The file `/var/spool/lpd/stat/numfile` contains an integer representing the last job number that was assigned. If it is satisfactory that the job numbering scheme restarts, enter:

```
rm /var/spool/lpd/stat/*
```

5. Remove spooled jobs:

```
rm /var/spool/lpd/qdir/*  
rm /var/spool/qdaemon/*
```

6. Restart the **qdaemon**.

```
startsrc -s qdaemon
```

While issuing the **ps** commands, you may find a process whose parent process ID (PPID) is **1**. If these processes cannot be killed by **kill -9**, you must reboot the system to delete these processes.

## Printing terminology

---

There are a number of terms that are commonly used with printing.

### formatter filter

Provides the capability of either formatting the input print file or passing it through unmodified, based on an input parameter. Even if the filter passes the input file unmodified, it still sends printer commands to initialize the printer before the input file is printed and restores the printer after printing is complete.

The formatter filter is made up of the following components:

- A device-independent formatter driver
- A device-dependent formatter

There is a formatter for each type (or group of types) of input data. For example, there is one formatter for all the supported IBM Proprinters.

Invoked by a pipeline, the formatter driver is passed the name of a formatter to be driven. The formatter driver dynamically loads and links the formatter and calls the formatter's **setup** function, which indicates whether data formatting or data pass-through is requested. After the formatter's **setup** function prepares the input file to be modified or passed through, it returns to the formatter driver. The formatter driver then calls the **initialize** function, which outputs a string of printer commands that starts the printer. For more information, see the **initialize** and **setup** functions.

The formatter driver next calls either the **passthru** function once or the **lineout** function for each line in the print file based on the return code from the **setup** function. If the **lineout** function is called, the formatter driver performs all vertical spacing either automatically (form feeds, top and bottom margins) or through the **lineout** function (line spacing, vertical tabs). For more information, see the **passthru** and **lineout** functions.

When processing is complete, the formatter driver calls the **restore** function. The **restore** function outputs a string of printer commands that restore the printer to its default state, which is defined by the database attribute values. See the **restore** function for more information.

For more information about how the print formatter interacts with the printer formatter subroutines, see the [“Print formatter example” on page 76](#).

### local printer

The printer attached to a node or host.

### print job

A unit of work to be run on a printer. A print job can consist of printing one or more files, depending on how the print job is requested. The system assigns a unique job number to each job it prints.

### print spooler

A generic spooling function that can be used for queuing various types of jobs, including print jobs queued to a printer. The spooler does not normally distinguish the types of jobs it is queuing. A system administrator defines a spooler queue based on the spooler backend program that is specified for the queue. For example, if the spooler backend program is the **piobe** command (the printer I/O backend), the queue is a print queue.

Likewise, if the spooler backend program is a compiler, the queue is for compile jobs. When the spooler's **qdaemon** process selects a job from a spooler queue, it runs the job by calling the backend program specified by the system administrator when the queue was defined.

When networks are composed of base operating system machines and other types of clients and servers, not all remote print requests are supported across the network. In some instances, you might have to submit print jobs one file at a time or concatenate files before submitting them as a print job.

The primary spooler command is the **enq** command. Although you can invoke this command directly to queue a print job, three front-end commands are defined for submitting a print job (see the **lp**, **lpr**, and **qprt** commands). A print request issued by one of these commands is first passed to the **enq** program, which then places the information about the file in the queue for the **qdaemon** to process. The queue is the `/var/spool/lpd/qdir` directory.

If the job is not a file (that is, pipe output of a command to **enq**), a real file is created in `/var/spool/qdaemon` that contains the data to be printed. The information in the `/var/spool/lpd/qdir` file points to the file in `/var/spool/qdaemon`.

### printer backend

A collection of programs called by the spooler's **qdaemon** process to manage a print job that is queued for printing. The printer backend performs the following functions:

- Receives a list of one or more files to be printed from the **qdaemon** process
- Uses printer and formatting attribute values from the database, overridden by flags entered on the command line
- Initializes the printer before printing a file

- Runs filters as necessary to convert the print data stream to a format supported by the printer
- Provides filters for simple formatting of ASCII documents
- Provides support for printing national language characters
- Passes the filtered print data stream to the printer device driver
- Generates header and trailer pages
- Generates multiple copies
- Reports printer error conditions, including out-of-paper and intervention-required errors
- Reports problems detected by the filters
- Cleans up after a print job is canceled
- Provides a print environment that a system administrator can customize to address specific printing needs

The **mkvirprt** command defines a virtual printer to the printer backend. The set of predefined attributes for the particular type of printer is copied to create a customized set of attributes. The customized attributes can be listed with the **lsvirprt** command and changed with the **chvirprt** command, with SMIT (**Change / Show Print Queue Characteristics** option). Each time the **mkvirprt** or **chvirprt** command is used, a digest utility (**pidigest** command) is automatically run to construct a memory image of the attribute values and lookup tables that are to be read in and used during the printing process.

The **qdaemon** command calls the **piobe** command (the Print Job Manager) and passes the flag options and the names of one or more files to be printed. The only flag options not passed are the spooler flag options removed by the **enq** command, because the **qdaemon** command has already opened the printer device and redirected standard output to the printer. A status file provides communication between the **qdaemon** and the backend.

If a header page is needed, the **piobe** command retrieves a header page pipeline that generates the header page. The header page pipeline is passed to a shell. In the pipeline, the standard output from the header page filter becomes the standard input for the formatter filter. The formatter filter processes the header page and writes the result to standard output. Standard output for the formatter filter becomes standard input for the device driver interface program that writes the filtered header page to the printer device driver.

### printer/plotter device

A special file in the `/dev` directory for the device. This file can be used by redirection (for example, `cat FileName > /dev/lp0`). Settings for the device driver can be displayed and changed using **chdev** commands. Before printer commands can access a printer device, a print queue must be created for the device, or the printer must be configured in the printer backend in `/etc/qconfig`.

### qdaemon

The **qdaemon** is a process that runs in the background and controls the queues. It is usually started by the **startsrc** command when the system is turned on.

The **qdaemon** keeps track of the print requests in the `/var/spool/lpd/qdir` directory and ensures that the jobs are sent to the proper printer at the proper time. It also keeps track of the status of the printers and stores printer usage data for system accounting purposes. This information is held in the `/var/spool/lpd/stat` directory and can be accessed using the **lpstat** and **enq -A** commands.

If the **qdaemon** is stopped, it is restarted by the **srcmstr** process.

**Note:** Do not stop the **srcmstr** process; it controls other daemons running on your system.

### queue

The location to which you direct a print job. It is a stanza in the `/etc/qconfig` file that matches the name of the queue. It points to the associated queue device. For example:

```
Msa1:
    device = lp0
```

### queue device

The stanza in the `/etc/qconfig` file that usually follows the local queue stanza. It specifies the `/dev` file (printer device) that should be printed to and the backend that should be used. For example:

```
lp0:
  file = /dev/lp0
  header = never
  trailer = never
  access = both
  backend = /usr/lpd/piobe
```

In the preceding example, `lp0` is the device name, and the rest of the lines define how the device is used.

### real printer

The printer hardware attached to a serial or parallel port at a unique hardware device address. The printer device driver in the kernel communicates with the printer hardware and provides an interface between the printer hardware and a virtual printer.

A real printer can be added with the `mkdev` command at the command line. See the [mkdev](#) command for more information.

### remote printer

A printer that is not directly attached to a local system. A remote print system allows nodes that are not directly linked to a printer to have printer access.

To use remote printing facilities, the individual nodes must be connected to a network using Transmission Control Protocol/Internet Protocol (TCP/IP) and must support the required TCP/IP applications.

### serial printer

A printer that performs functions sequentially, such as printing one character at a time.

Serial printers are normally configured as DTEs; that is, they expect to receive data on the *receive* data line and transmit data on the *transmit* data line. Serial printers default to EIA-232 connections and use DB-25 D-type connectors. Many printers also support EIA-422 connections.

### virtual printer

Also called a *virtual printer definition*, this is a file containing a set of attribute values that describe a particular data stream (such as ASCII or PostScript) for a particular printer. This does not include information about how the printer hardware is attached to the host computer or about the protocol used for transferring bytes of data to and from the printer. A virtual printer is associated with a print queue. You can define a print queue for each data stream the printer supports. Multiple print queues can use the same real printer.

Before a print job can be placed in a queue, a virtual printer definition must exist for both the print queue and the queue device. For more information, see the [mkvirprt](#) command.



## Notices

---

This information was developed for products and services offered in the US.

IBM may not offer the products, services, or features discussed in this document in other countries. Consult your local IBM representative for information on the products and services currently available in your area. Any reference to an IBM product, program, or service is not intended to state or imply that only that IBM product, program, or service may be used. Any functionally equivalent product, program, or service that does not infringe any IBM intellectual property right may be used instead. However, it is the user's responsibility to evaluate and verify the operation of any non-IBM product, program, or service.

IBM may have patents or pending patent applications covering subject matter described in this document. The furnishing of this document does not grant you any license to these patents. You can send license inquiries, in writing, to:

*IBM Director of Licensing  
IBM Corporation  
North Castle Drive, MD-NC119  
Armonk, NY 10504-1785  
US*

For license inquiries regarding double-byte character set (DBCS) information, contact the IBM Intellectual Property Department in your country or send inquiries, in writing, to:

*Intellectual Property Licensing  
Legal and Intellectual Property Law  
IBM Japan Ltd.  
19-21, Nihonbashi-Hakozakicho, Chuo-ku  
Tokyo 103-8510, Japan*

INTERNATIONAL BUSINESS MACHINES CORPORATION PROVIDES THIS PUBLICATION "AS IS" WITHOUT WARRANTY OF ANY KIND, EITHER EXPRESS OR IMPLIED, INCLUDING, BUT NOT LIMITED TO, THE IMPLIED WARRANTIES OF NON-INFRINGEMENT, MERCHANTABILITY OR FITNESS FOR A PARTICULAR PURPOSE. Some jurisdictions do not allow disclaimer of express or implied warranties in certain transactions, therefore, this statement may not apply to you.

This information could include technical inaccuracies or typographical errors. Changes are periodically made to the information herein; these changes will be incorporated in new editions of the publication. IBM may make improvements and/or changes in the product(s) and/or the program(s) described in this publication at any time without notice.

Any references in this information to non-IBM websites are provided for convenience only and do not in any manner serve as an endorsement of those websites. The materials at those websites are not part of the materials for this IBM product and use of those websites is at your own risk.

IBM may use or distribute any of the information you provide in any way it believes appropriate without incurring any obligation to you.

Licensees of this program who wish to have information about it for the purpose of enabling: (i) the exchange of information between independently created programs and other programs (including this one) and (ii) the mutual use of the information which has been exchanged, should contact:

*IBM Director of Licensing  
IBM Corporation  
North Castle Drive, MD-NC119  
Armonk, NY 10504-1785  
US*

Such information may be available, subject to appropriate terms and conditions, including in some cases, payment of a fee.

The licensed program described in this document and all licensed material available for it are provided by IBM under terms of the IBM Customer Agreement, IBM International Program License Agreement or any equivalent agreement between us.

The performance data and client examples cited are presented for illustrative purposes only. Actual performance results may vary depending on specific configurations and operating conditions.

Information concerning non-IBM products was obtained from the suppliers of those products, their published announcements or other publicly available sources. IBM has not tested those products and cannot confirm the accuracy of performance, compatibility or any other claims related to non-IBM products. Questions on the capabilities of non-IBM products should be addressed to the suppliers of those products.

Statements regarding IBM's future direction or intent are subject to change or withdrawal without notice, and represent goals and objectives only.

All IBM prices shown are IBM's suggested retail prices, are current and are subject to change without notice. Dealer prices may vary.

This information is for planning purposes only. The information herein is subject to change before the products described become available.

This information contains examples of data and reports used in daily business operations. To illustrate them as completely as possible, the examples include the names of individuals, companies, brands, and products. All of these names are fictitious and any similarity to actual people or business enterprises is entirely coincidental.

#### COPYRIGHT LICENSE:

This information contains sample application programs in source language, which illustrate programming techniques on various operating platforms. You may copy, modify, and distribute these sample programs in any form without payment to IBM, for the purposes of developing, using, marketing or distributing application programs conforming to the application programming interface for the operating platform for which the sample programs are written. These examples have not been thoroughly tested under all conditions. IBM, therefore, cannot guarantee or imply reliability, serviceability, or function of these programs. The sample programs are provided "AS IS", without warranty of any kind. IBM shall not be liable for any damages arising out of your use of the sample programs.

Each copy or any portion of these sample programs or any derivative work must include a copyright notice as follows:

© (your company name) (year).

Portions of this code are derived from IBM Corp. Sample Programs.

© Copyright IBM Corp. \_enter the year or years\_.

## Privacy policy considerations

---

IBM Software products, including software as a service solutions, (“Software Offerings”) may use cookies or other technologies to collect product usage information, to help improve the end user experience, to tailor interactions with the end user or for other purposes. In many cases no personally identifiable information is collected by the Software Offerings. Some of our Software Offerings can help enable you to collect personally identifiable information. If this Software Offering uses cookies to collect personally identifiable information, specific information about this offering’s use of cookies is set forth below.

This Software Offering does not use cookies or other technologies to collect personally identifiable information.

If the configurations deployed for this Software Offering provide you as the customer the ability to collect personally identifiable information from end users via cookies and other technologies, you should seek your own legal advice about any laws applicable to such data collection, including any requirements for notice and consent.

For more information about the use of various technologies, including cookies, for these purposes, see IBM's Privacy Policy at <http://www.ibm.com/privacy> and IBM's Online Privacy Statement at <http://www.ibm.com/privacy/details> the section entitled "Cookies, Web Beacons and Other Technologies" and the "IBM Software Products and Software-as-a-Service Privacy Statement" at <http://www.ibm.com/software/info/product-privacy>.

## Trademarks

---

IBM, the IBM logo, and [ibm.com](http://www.ibm.com) are trademarks or registered trademarks of International Business Machines Corp., registered in many jurisdictions worldwide. Other product and service names might be trademarks of IBM or other companies. A current list of IBM trademarks is available on the web at [Copyright and trademark information at www.ibm.com/legal/copytrade.shtml](http://www.ibm.com/legal/copytrade.shtml).

UNIX is a registered trademark of The Open Group in the United States and other countries.



---

# Index

## Special Characters

/etc/qconfig file structure [53](#)

## Numerics

5080 Attachment Adapter [18](#)

## A

adapter  
  transparent printing [134](#)  
ASCII terminal  
  configuring a printer for [23](#)  
ASCII to PostScript  
  automating conversion [11](#), [13](#)  
  converting files [11](#), [13](#)  
  printing [11](#)  
attachment files [89](#)

## B

back-end  
  routines libqb [83](#)  
backend  
  processing [49](#)

## C

canceling  
  print jobs [4](#), [5](#)  
Canon LASER SHOT printer [156](#)  
checking  
  status of print jobs [9](#)  
chmod command [266](#)  
chpq command [13](#)  
chvirprt command [272](#)  
code sets  
  multibyte [85](#)  
colon files  
  limits field operators [93](#)  
  to add a printer [99](#)  
command summaries  
  printing [13](#)  
commands  
  chmod [266](#)  
  chpq [13](#)  
  chvirprt [272](#)  
  crontab [266](#)  
  df [263](#)  
  du [266](#)  
  enq [14](#), [265](#), [272](#)  
  grep [263](#)  
  lp [272](#)  
  lpq [265](#)  
  lpr [272](#)

commands (*continued*)

  lprm [265](#)  
  lpstat [263](#)  
  lsvirprt [272](#)  
  mkprtdap [254](#)  
  mkvirprt [272](#)  
  mount [266](#)  
  piobe [14](#), [272](#)  
  piodigest [272](#)  
  pr [10](#)  
  ps [263](#)  
  pwd [263](#)  
  qcan [4](#), [265](#)  
  qchk [8](#)  
  qdaemon [14](#)  
  qdaemon command [272](#)  
  qmov [6](#)  
  qpri [5](#)  
  qprt [1](#), [11](#), [14](#), [272](#)  
  rm [263](#)  
  smit [1](#), [5](#), [6](#), [9](#), [13](#)  
  split [265](#)  
  startsrc [263](#)  
configuring  
  printer or plotter connected to RAN [135](#)  
controlling  
  printing process [14](#)  
converting  
  ASCII files to PostScript [11](#)  
crontab command [266](#)

## D

Dataproducts printers [156](#)  
devices  
  printers or plotters [272](#)  
  queue [272](#)  
df command [263](#)  
du command [266](#)

## E

enq command [14](#), [265](#), [272](#)  
encrypt filter [11](#)  
escape sequences  
  arithmetic operators [65](#)  
  ASCII output [65](#)  
  binary output [65](#)  
  bitwise logical operators [65](#)  
  command line flags [65](#)  
  conditional operators [65](#)  
  description of [65](#)  
  input values [65](#)  
  internal variables [65](#)  
  logical operators [65](#)  
  pass through from input to output [65](#)  
  relational operators [65](#)

## F

- files
  - formatting for printing [10](#)
  - printing ASCII on a PostScript printer [11](#)
- filters, formatter [52](#)
- flags
  - for pr command [10](#)
  - for qprt command [1](#), [11](#)
- formatter filter
  - definition [272](#)
- formatting
  - files for printing [10](#)

## G

- grep command [263](#)

## H

- Hewlett-Packard printer information [156](#)

## I

- IBM printers [137](#)
- iconv subroutine [85](#)

## L

- LDAP
  - configure server [254](#)
  - configure storage [254](#)
- Lexmark 4227 Forms Printer [164](#)
- Lexmark Optra C Color laserprinter [184](#)
- Lexmark Optra E Laser Printer [186](#)
- Lexmark Optra laserprinter [165](#)
- Lexmark Optra N Laser Printer [189](#)
- Lexmark Optra Plus laserprinter [168](#)
- Lexmark Plus Printers [212](#)
- libqb, back-end routines [83](#)
- local printers
  - definition [272](#)
- lp command [272](#)
- lpd
  - daemon [34](#)
- lpq command [265](#)
- lpr command [272](#)
- lprm command [265](#)
- lpstat command [263](#)
- lsvirprt command [272](#)

## M

- mkvirprt command [272](#)
- mount command [266](#)
- moving
  - print jobs [6](#)

## O

- overriding
  - auto-determination of print file types [13](#)

## P

- piobe command [14](#), [28](#), [272](#)
- piodigest command [272](#)
- pioout command [28](#)
- PIOTERM environment variables [23](#)
- plotter
  - adding support for [18](#)
- PostScript files
  - converting from ASCII [11](#), [13](#)
- PostScript printers
  - printing ASCII files [11](#)
- pr command
  - flags [10](#)
- print formatter
  - example of [76](#)
- print jobs
  - canceling [4](#), [5](#)
  - checking status [8](#), [9](#)
  - definition [272](#)
  - moving [6](#)
  - prioritizing [5](#)
  - scheduling [29](#)
  - starting [1](#)
- print queue
  - adding
    - print queue device [18](#)
  - characteristics [29](#)
  - clearing [263](#)
  - deleting [30](#)
  - device
    - characteristics [29](#)
    - deleting [30](#)
  - listing
    - print queues [28](#)
  - mounting more space [266](#)
  - removing a job [265](#)
  - setting permissions [266](#)
  - splitting a job [265](#)
  - starting and stopping [28](#)
  - status conditions [8](#), [9](#), [31](#)
  - using disk space [266](#)
  - working with files [266](#)
- print server
  - remote [36](#), [263](#)
- print spoolers
  - definition [272](#)
- printer
  - adding an undefined
    - procedure of using colon file [99](#)
  - backend
    - commands [28](#)
  - colon files
    - limits field operators [93](#)
  - configuring
    - printer for an ASCII terminal [23](#)
  - configuring nonsupported [20](#)
  - control codes [14](#)
  - control information [14](#)
  - defined
    - listing [30](#)
  - deleting [30](#)
  - nonsupported
    - configuring of [20](#)

- printer (*continued*)
    - physical [54](#)
    - remote
      - managing [35](#)
    - specific information
      - Canon LASER SHOT [156](#)
      - Dataproducts printers [156](#)
      - Hewlett-Packard printers [156](#)
      - IBM printers [137](#)
      - Lexmark 4227 Forms Printer [164](#)
      - Lexmark Optra [165](#)
      - Lexmark Optra C Color [184](#)
      - Lexmark Optra E [186](#)
      - Lexmark Optra N [189](#)
      - Lexmark Optra Plus [168](#)
      - Lexmark Plus Printers [212](#)
      - Printronix printers [214](#)
      - QMS printers [214](#)
      - TI printers [214](#)
    - subsystem [14](#)
    - supported
      - listing [30](#)
    - terminal-attached
      - installing [22](#)
      - limitations [24](#)
    - virtual
      - attributes, described [57](#)
  - printer backend
    - definition [272](#)
  - printer code page
    - translation table [85](#)
  - printer troubleshooting
    - 8-bit printer attached to 7-bit interface [268](#)
    - adapter considerations [262](#)
    - inoperative printers [261](#)
    - local printer checklist [261](#)
    - qdaemon problems [268](#)
    - queuing system [269](#)
    - remote printer checklist [262](#)
    - terminal-attached printer checklist [267](#)
  - printer/plotter device
    - definition [272](#)
  - printers
    - formatter filter [272](#)
    - local [272](#)
    - real [272](#)
    - remote [272](#)
    - serial [272](#)
    - status conditions [9](#)
    - terminal-attached
      - adding a print queue [136](#)
      - configuring for the 128-port [135](#)
      - configuring the auxiliary port [136](#)
      - testing [137](#)
    - virtual [272](#)
  - printing
    - administration [14](#)
    - ASCII files on a PostScript printer [11](#)
    - canceling print jobs [4](#), [5](#)
    - checking status of print jobs [9](#)
    - devices [272](#)
    - formatter filter [272](#)
    - formatting files for [10](#)
    - local printers [272](#)
    - moving print jobs [6](#)
    - overriding print file types [13](#)
    - overview [1](#)
    - print jobs [272](#)
    - printer backend [272](#)
    - prioritizing print jobs [5](#)
    - qdaemon [272](#)
    - queue [272](#)
    - queue devices [272](#)
    - real printers [272](#)
    - remote printers [272](#)
    - serial printers [272](#)
    - spoolers [272](#)
    - starting print jobs [1](#)
    - status conditions of printers [8](#), [9](#)
    - terminology [272](#)
    - using qprt command [14](#)
    - using smit command [14](#)
    - virtual printers [272](#)
  - printing problems
    - clearing print queue [263](#)
    - deleting files [266](#)
    - reallocating printer resources [265](#)
  - Printronix printers [214](#)
  - prioritizing
    - print jobs [5](#)
  - processes
    - qdaemon [272](#)
    - srcmstr [272](#)
    - startsrc [272](#)
  - processing, backend [49](#)
  - ps command [263](#)
  - pwd command [263](#)
- Q**
- qcan command [4](#), [265](#)
  - qchk command [9](#)
  - qconfig file [35](#)
  - qdaemon
    - checklist [268](#)
    - definition [272](#)
    - printer backend [272](#)
    - restarting [269](#)
  - qdaemon command [14](#), [272](#)
  - qmov command [6](#)
  - QMS printers [214](#)
  - qpri command [5](#)
  - qprt command
    - flags [1](#), [11](#)
    - printing files [14](#)
    - using X fonts with [88](#)
  - queue
    - status conditions [9](#)
  - queue daemon
    - reactivating [263](#)
  - queue devices
    - definition [272](#)
  - queues
    - definition [272](#)
  - queuing system
    - status conditions [31](#)

## R

- RAN
  - configuring [135](#)
- real printers
  - definition [272](#)
- rembak program [33](#)
- remote print server [263](#)
- remote printer
  - checklist [262](#)
  - managing [35](#)
- remote printers
  - definition [272](#)
- remote printing
  - overview [33](#)
- rm command [263](#)
- RS-232 adapter
  - printer considerations [262](#)

## S

- serial printers
  - definition [272](#)
- SMIT (System Management Interface Tool)
  - interface to printer attachment files [89](#)
  - sm\_cmd\_obj object class
    - used with printer files [93](#)
- smit command
  - canceling a print job [5](#)
  - checking status of a print job [9](#)
  - converting ASCII to PostScript [13](#)
  - moving a print job [6](#)
  - printing files [14](#)
  - prioritizing a print job [5](#)
  - starting a print job [1](#)
- smit mount command [266](#)
- split command [265](#)
- spooler
  - configuration file
    - etc/qconfig file structure [53](#)
  - data flow [47](#)
  - parts [47](#)
  - queues [54](#)
- spoolers
  - definition [272](#)
- spooling directory
  - mounting more space [266](#)
  - setting permissions [266](#)
  - working with files [266](#)
- starting
  - print jobs [1](#)
- startsrc command [263](#)
- status conditions
  - of printers [8](#), [9](#)
- summaries
  - for printing [13](#)

## T

- terminal-attached printer
  - checklist [267](#)
- terminal-attached printers
  - setting up the hardware [136](#)

- terminal-attached printing
  - hardware supported [24](#)
  - using a modem [23](#)
- Text Formatting System [11](#)
- TI printers [214](#)
- translation tables
  - example [88](#)
  - multibyte code sets [87](#)
- transparent printing [134](#)
- troubleshooting
  - printer [260](#)

## V

- virtual printers
  - attributes described [57](#)
  - definition [272](#)



